

(19)
(12)

(KR)
(B1)

(51) 。 Int. Cl.7
H05B 33/08

(45)
(11)
(24)

2005 01 15
10-0466628
2005 01 06

(21) 10-2002-0070095
(22) 2002 11 12

(65)
(43)

10-2004-0041982
2004 05 20

(73)

575

(72)

105 504

4 967-22 1 101

(74)

:

(54)

;

가

2c

1

가

2a	2c	1	SLS
3a	3d	2	MIC/MILC
4a	4b	3	MIC/MILC
5a	5f	3	MIC/MILC

*
 200, 300, 400 : 210, 310, 410 :
 220, 320, 420 : 230, 330 :
 232, 336 :
 236, 332 :

(EL)

(AMOLED)

5 WVGA AMOLED 가

50cd/m², 45.5μm x 136.5μm, 180ppi

가 가 EL EL

AMOLED 가 EL

(EL) .2 , EL

EL 가

가 가

가 가

EL 가

EL

(W/L) 가 가

가 W/L ELA W/L

가 가

가
가
MIC MILC
MILC
가
2
SLS 가 가 10
가 MIC/MILC , MILC , MIC 가
, SLS
LC MILC MILC MIC/MILC MILC MI
1 가 (140) (EL (140) (data) (150) (145) 2 p (TFT) , (100) (150) (Scan) (145) (Vgs) EL (160) (120) 가 (140) (data)
가 TFT (140) TFT (145) 가 TFT (145)
EL (160) 가

가
 2a 2c 1 SLS(sequential lateral solidification)
 2a (200) (210) (210) (220)
 (220) (grain size)
 225) 가 (250) (220) (211) 가 (250) (
 2b (250) SLS (220)
 (230) (230) 가 (250) 가 (235)
 SLS (231) 가 (235) (grain size)가 10
 2c (230) 1 (231) 2 (235) (230)
 (((232), (236)) 1 (232)
 1 2 (230) 가 1 (231) (230)
 가 2 (235) 2 (236) (230)
 가 1 SLS 가 (250)
 (232) (230) (236) (250)
 (220) 1 (250)
 1 가 2
 3a 3d 2 MIC/MILC
 3a (300) (310) (310) (320)
 (350) (320) MILC (340) (340)
 (320) (350) (325)
 3b (340) (350) (360), Ni (350) MILC
 MILC (340) MILC (33) (320)
 1) MILC (335) (330) 가 (320)
 (360) (321) MIC (331)
 가 (340) (360) (325) MILC
 3c (335) (360) 3d (332) 2
) (330) 1 (332) 2
 (336) 1 (332) , MIC 가
 1 (336)
 , MILC 가
 가
 4a 4b 3 MIC/MILC 가
 4a (400) (410) (410) (420)
 (420) MILC (441), (442) MILC
 (460) MILC (441)
 MILC (442)

MILC (441) (W1) MILC (442) (W2) .
 4b , MIC/MILC (420) MIC (460)
 (435) MILC (431), (432) , (420) (420)
 (422) MILC (425) MIC , MILC (442)
 (421) MILC MILC MILC (432) (435) , MILC (441) MILC (431)
 (421a) MILC (421a) MILC (431)
 ()
 (432) , MILC (431) MILC (421
 a) MILC (431)
 MILC 가 ,
 MILC ,
 5a 5f 3 MILC
 5a 5f (512)
 5a MILC (511) MILC (511) (515)
 5b 5c MILC (521), (531) MILC (521), (531)
 (525), (535) 5d 5e
 (545), (555) MILC (541), (551) , 5f (565)

EL , 가 가 ,
 가, EL 가

(57)

1.

;
 ; 가

2.

1 ,

3.

1 , 가

4.

1 , ,

- 4 5. ,
- 5 6. , MILC
- 1 7. , MIC , MILC
- 8. ; ; 가
- 8 9. ,
- 8 10. , ,
- 10 11. ,
- 11 12. , MILC
- 8 13. , MIC
- MILC 14. ; ; 2 ;
- 14 15. , SLS 가 가 가 1
0 가 ,
- 14 16. , MIC/MILC , MILC , MILC 가 가
, MILC
- 17. ; ; ,
- 17 18. , , SLS
- 19.

17
MILC
MILC
20.
19
LC

MIC/MILC

MILC
MILC

MILC

MILC

, MI

1

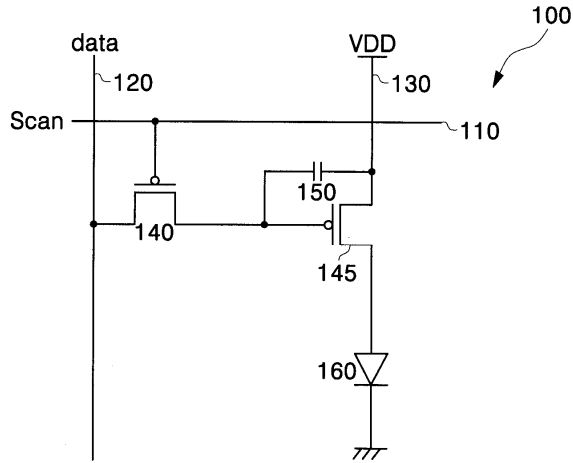

2a

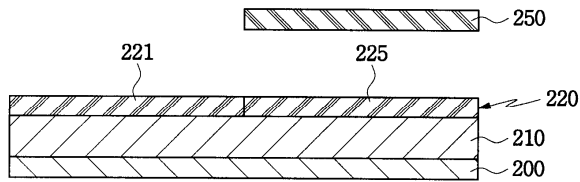

2b

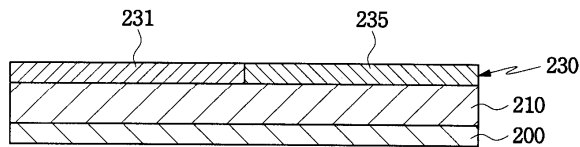

2c

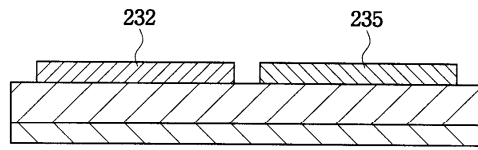

3a

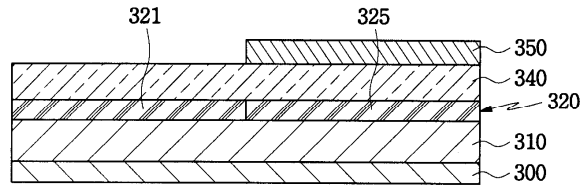

3b

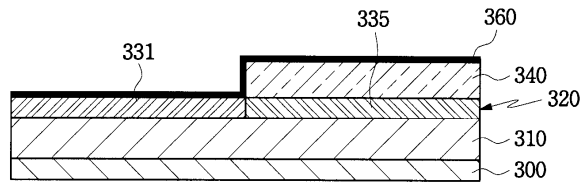

3c

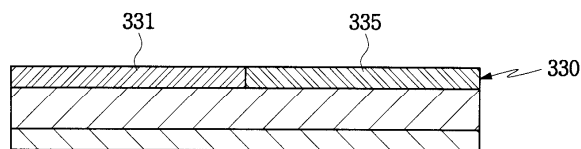

3d

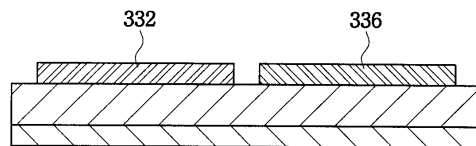

4a

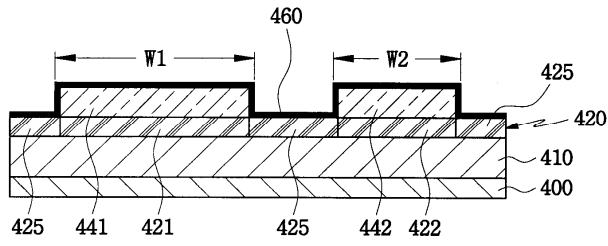

4b

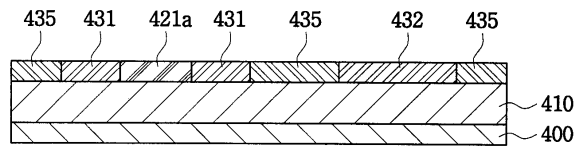

5a

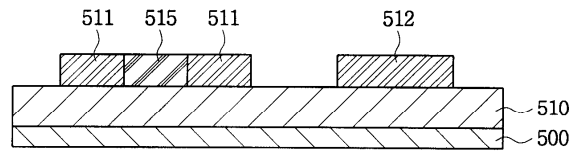

5b

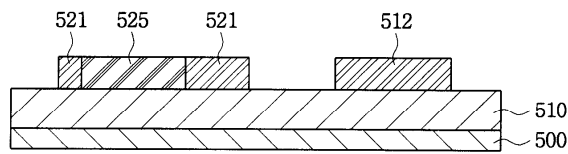

5c

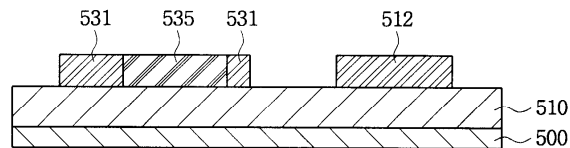

5d

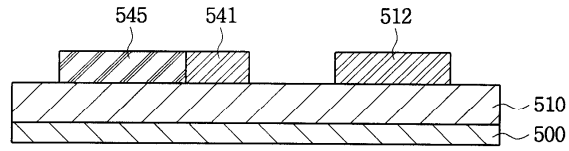

5e

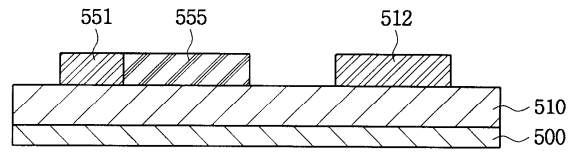

5f

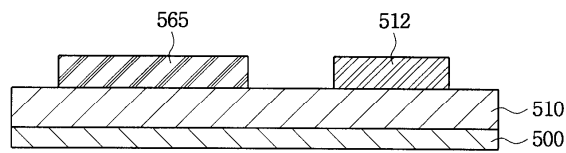

专利名称(译)	平板显示器及其制造方法		
公开(公告)号	KR100466628B1	公开(公告)日	2005-01-15
申请号	KR1020020070095	申请日	2002-11-12
申请(专利权)人(译)	三星SD眼有限公司		
当前申请(专利权)人(译)	三星SD眼有限公司		
[标]发明人	KOO JAEBON 구재본 PARK SANGIL 박상일		
发明人	구재본 박상일		
IPC分类号	H05B33/08 G09F9/33 G09G3/32 H01L21/00 H01L21/20 H01L21/77 H01L27/12 H01L27/15 H01L27/32 H01L29/04 H01L51/40 H05B33/00		
CPC分类号	H01L27/3262 H01L21/02532 H01L27/1277 H01L29/04 H01L21/02672 H01L21/02422 H01L27/1229		
代理人(译)	Baksangsu		
其他公开文献	KR1020040041982A		
外部链接	Espacenet		

摘要(译)

有机发光显示装置技术领域本发明涉及一种有机发光显示装置，其能够在维持开关晶体管的开关特性的同时，通过改变驱动晶体管的迁移率来控制每单位像素流过有机发光装置的电流。本发明的有源矩阵有机发光显示装置包括有机发光装置；和有机发光装置。用于传输数据信号的开关晶体管；并且，驱动晶体管驱动有机发光器件，使得一定量的电流根据数据信号流过有机发光器件，并且驱动晶体管和开关晶体管的半导体层具有不同的迁移率。开关晶体管的半导体层由多晶硅膜制成，并且驱动晶体管的半导体层由粒径小于开关晶体管的半导体层的多晶硅膜制成，或者包括非晶硅膜。通过使开关晶体管和驱动晶体管的半导体层的迁移率不同，本发明的有源矩阵有机发光显示装置可以在保持开关晶体管的开关特性的同时减少流过驱动晶体管的电流。图2c

