

(19) World Intellectual Property Organization  
International Bureau



(43) International Publication Date  
27 May 2010 (27.05.2010)

(10) International Publication Number  
**WO 2010/059837 A2**

(51) International Patent Classification:  
*C09K 11/06* (2006.01) *H05B 33/00* (2006.01)

19810 (US). **GAO, Weiyang** [CN/US]; 223 Chaingate Circle, Landenberg, Pennsylvania 19350 (US).

(21) International Application Number:  
PCT/US2009/065163

(74) Agent: **LAMMING, John, H.**; E. I. du Pont de Nemours and Company, Legal Patent Records Center, 4417 Lancaster Pike, Wilmington, Delaware 19805 (US).

(22) International Filing Date:  
19 November 2009 (19.11.2009)

(81) Designated States (unless otherwise indicated, for every kind of national protection available): AE, AG, AL, AM, AO, AT, AU, AZ, BA, BB, BG, BH, BR, BW, BY, BZ, CA, CH, CL, CN, CO, CR, CU, CZ, DE, DK, DM, DO, DZ, EC, EE, EG, ES, FI, GB, GD, GE, GH, GM, GT, HN, HR, HU, ID, IL, IN, IS, JP, KE, KG, KM, KN, KP, KR, KZ, LA, LC, LK, LR, LS, LT, LU, LY, MA, MD, ME, MG, MK, MN, MW, MX, MY, MZ, NA, NG, NI, NO, NZ, OM, PE, PG, PH, PL, PT, RO, RS, RU, SC, SD, SE, SG, SK, SL, SM, ST, SV, SY, TJ, TM, TN, TR, TT, TZ, UA, UG, US, UZ, VC, VN, ZA, ZM, ZW.

(25) Filing Language: English

(26) Publication Language: English

(30) Priority Data:  
61/115,984 19 November 2008 (19.11.2008) US

(71) Applicant (for all designated States except US): **E. I. DU PONT DE NEMOURS AND COMPANY** [US/US]; 1007 Market Street, Wilmington, Delaware 19898 (US).

(72) Inventors; and  
(75) Inventors/Applicants (for US only): **WU, Weishi** [US/US]; 1 Tortoiseshell Lane, Landenberg, Pennsylvania 19350 (US). **HERRON, Norman** [GB/US]; 408 Apple Road, Newark, Delaware 19711 (US). **ROSTOVTSEV, Vsevolod** [RU/US]; 243 Kenyon Avenue, Swarthmore, Pennsylvania 19081 (US). **MERLO, Jeffrey, A.** [US/US]; 6 Creighton Drive, Wilmington, Delaware

(84) Designated States (unless otherwise indicated, for every kind of regional protection available): ARIPO (BW, GH, GM, KE, LS, MW, MZ, NA, SD, SL, SZ, TZ, UG, ZM, ZW), Eurasian (AM, AZ, BY, KG, KZ, MD, RU, TJ, TM), European (AT, BE, BG, CH, CY, CZ, DE, DK, EE, ES, FI, FR, GB, GR, HR, HU, IE, IS, IT, LT, LU, LV, MC, MK, MT, NL, NO, PL, PT, RO, SE, SI, SK, SM,

[Continued on next page]

(54) Title: CHRYSENE COMPOUNDS FOR BLUE OR GREEN LUMINESCENT APPLICATIONS

FIGURE 1

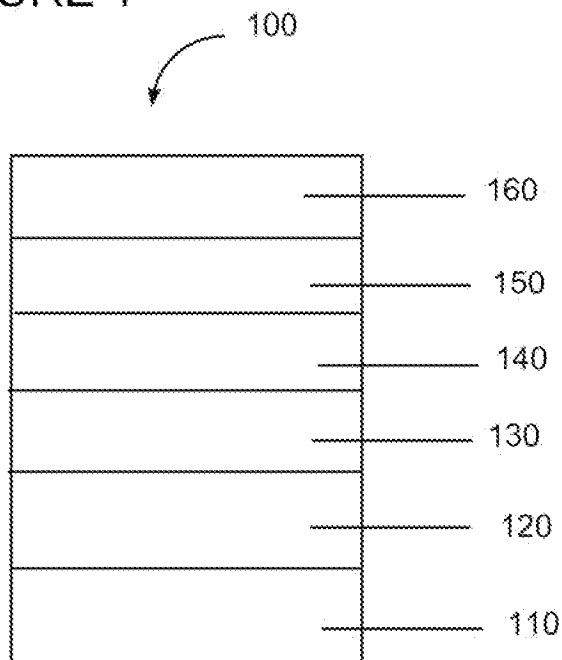

(57) Abstract: This invention relates to chrysene compounds that are useful in electroluminescent applications and are capable of blue or green emission. It also relates to electronic devices in which the active layer includes such a chrysene compound.

WO 2010/059837 A2

TR), OAPI (BF, BJ, CF, CG, CI, CM, GA, GN, GQ, GW, ML, MR, NE, SN, TD, TG). **Published:**

— *without international search report and to be republished upon receipt of that report (Rule 48.2(g))*

TITLECHRYSENE COMPOUNDS FOR BLUE OR GREEN LUMINESCENT  
APPLICATIONSRELATED APPLICATION

5 This application claims priority under 35 U.S.C. § 119(e) from Provisional Application No. 61/115,984 filed November 19, 2008, which is incorporated by reference in its entirety.

BACKGROUNDField of the Disclosure

10 This invention relates to electroluminescent chrysene compounds which have blue or green emission. It also relates to electronic devices in which the active layer includes such a chrysene compound.

Description of the Related Art

15 Organic electronic devices that emit light, such as light-emitting diodes that make up displays, are present in many different kinds of electronic equipment. In all such devices, an organic active layer is sandwiched between two electrical contact layers. At least one of the electrical contact layers is light-transmitting so that light can pass through the electrical contact layer. The organic active layer emits light through  
20 the light-transmitting electrical contact layer upon application of electricity across the electrical contact layers.

It is well known to use organic electroluminescent compounds as the active component in light-emitting diodes. Simple organic molecules such as anthracene, thiadiazole derivatives, and coumarin derivatives are  
25 known to show electroluminescence. Semiconductive conjugated polymers have also been used as electroluminescent components, as has been disclosed in, for example, U.S. Patent 5,247,190, U.S. Patent 5,408,109, and Published European Patent Application 443 861.

30 However, there is a continuing need for electroluminescent compounds, especially compounds that are blue-emitting.

SUMMARY

There is provided a compound having Formula I:

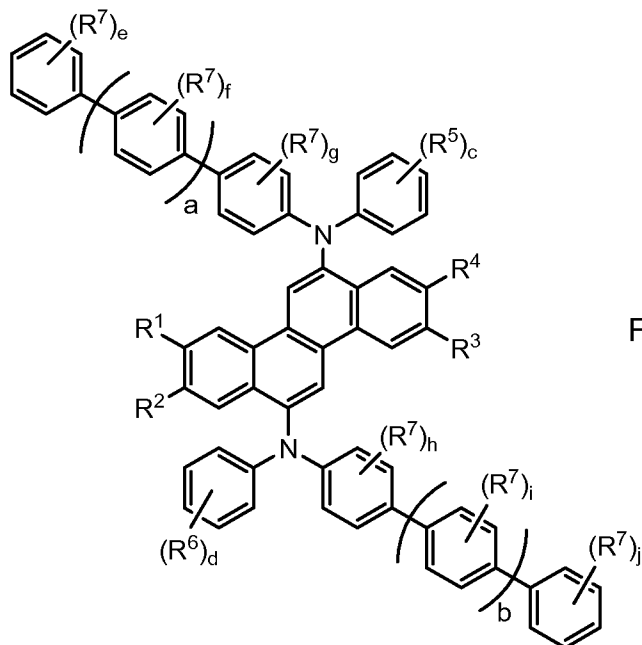

Formula I

wherein:

$R^1$ ,  $R^2$ ,  $R^3$  and  $R^4$  are the same or different and are selected from the group consisting of H and alkyl, where  $R^1$  and  $R^2$  groups or  $R^3$  and  $R^4$  groups may be joined together to form a 5- or 6-  
 5 membered aliphatic ring;

$R^5$  and  $R^6$  are the same or different and are selected from the group consisting of alkyl groups, m-phenyl, o-phenyl, p-phenyl, m-carbazolyl, and p-carbazolyl;

$R^7$  is the same or different at each occurrence and is selected from the group consisting of alkyl groups, phenyl, and biphenyl, or two adjacent  $R^7$  groups can join together to form a naphthyl  
 10 group;

a and b are the same or different and are an integer from 0-10;

c and d are the same or different and are an integer from 1-3;

f, g, h, and i, are the same or different at each occurrence and are an integer from 0-4; and  
 15

e and j are the same or different at each occurrence and are an integer from 0-5.

There is also provided an electronic device comprising an active  
 20 layer comprising the compound of Formula I.

### BRIEF DESCRIPTION OF THE DRAWINGS

Embodiments are illustrated in the accompanying figures to improve understanding of concepts as presented herein.

FIG. 1 includes an illustration of one example of an organic  
5 electronic device.

FIG. 2 includes a graph of relative device lifetimes.

Skilled artisans appreciate that objects in the figures are illustrated for simplicity and clarity and have not necessarily been drawn to scale. For example, the dimensions of some of the objects in the figures may be  
10 exaggerated relative to other objects to help to improve understanding of embodiments.

### DETAILED DESCRIPTION

Many aspects and embodiments are disclosed herein and are exemplary and not limiting. After reading this specification, skilled artisans  
15 appreciate that other aspects and embodiments are possible without departing from the scope of the invention.

Other features and benefits of any one or more of the embodiments will be apparent from the following detailed description, and from the claims. The detailed description first addresses Definitions and  
20 Clarification of Terms followed by the Chrysene Compound, the Electronic Device, and finally Examples.

#### 1. Definitions and Clarification of Terms

Before addressing details of embodiments described below, some terms are defined or clarified.

25 As used herein, the term "aliphatic ring" is intended to mean a cyclic group that does not have delocalized pi electrons. In some embodiments, the aliphatic ring has no unsaturation. In some embodiments, the ring has one double or triple bond.

The term "alkyl" is intended to mean a group derived from an  
30 aliphatic hydrocarbon having one point of attachment, and includes a linear, a branched, or a cyclic group. The term is intended to include heteroalkyls. The term "hydrocarbon alkyl" refers to an alkyl group having no heteroatoms. In some embodiments, an alkyl group has from 1-20 carbon atoms.

The term "aryl" is intended to mean a group derived from an aromatic hydrocarbon having one point of attachment. The term includes groups which have a single ring and those which have multiple rings which can be joined by a single bond or fused together. The term is intended to include heteroaryls. The term "arylene" is intended to mean a group derived from an aromatic hydrocarbon having two points of attachment. In some embodiments, an aryl group has from 3-60 carbon atoms.

The term "blue" refers to radiation that has an emission maximum at a wavelength in a range of approximately 400-500 nm.

The term "branched alkyl" refers to an alkyl group having at least one secondary or tertiary carbon. The term "secondary alkyl" refers to a branched alkyl group having a secondary carbon atom. The term "tertiary alkyl" refers to a branched alkyl group having a tertiary carbon atom. In some embodiments, the branched alkyl group is attached via a secondary or tertiary carbon.

The term "compound" is intended to mean an electrically uncharged substance made up of molecules that further consist of atoms, wherein the atoms cannot be separated by physical means. The phrase "adjacent to," when used to refer to layers in a device, does not necessarily mean that one layer is immediately next to another layer. On the other hand, the phrase "adjacent R groups," is used to refer to R groups that are next to each other in a chemical formula (i.e., R groups that are on atoms joined by a bond). The term "photoactive" refers to any material that exhibits electroluminescence and/or photosensitivity.

The term "green" refers to radiation that has an emission maximum at a wavelength in a range of approximately 500-600 nm.

The prefix "hetero" indicates that one or more carbon atoms have been replaced with a different atom. In some embodiments, the different atom is N, O, or S.

The term "layer" is used interchangeably with the term "film" and refers to a coating covering a desired area. The term is not limited by size. The area can be as large as an entire device or as small as a specific functional area such as the actual visual display, or as small as a single sub-pixel. Layers and films can be formed by any conventional deposition

technique, including vapor deposition, liquid deposition (continuous and discontinuous techniques), and thermal transfer. Continuous deposition techniques, include but are not limited to, spin coating, gravure coating, curtain coating, dip coating, slot-die coating, spray coating, and continuous  
5 nozzle coating. Discontinuous deposition techniques include, but are not limited to, ink jet printing, gravure printing, and screen printing.

The term "organic electronic device" or sometimes just "electronic device" is intended to mean a device including one or more organic semiconductor layers or materials.

10 All groups are unsubstituted unless otherwise indicated. In some embodiments, the substituents are selected from the group consisting of halide, alkyl, alkoxy, aryl, and cyano.

Unless otherwise defined, all technical and scientific terms used herein have the same meaning as commonly understood by one of  
15 ordinary skill in the art to which this invention belongs. Although methods and materials similar or equivalent to those described herein can be used in the practice or testing of the present invention, suitable methods and materials are described below. All publications, patent applications, patents, and other references mentioned herein are incorporated by  
20 reference in their entirety. In case of conflict, the present specification, including definitions, will control. In addition, the materials, methods, and examples are illustrative only and not intended to be limiting.

The IUPAC numbering system is used throughout, where the groups from the Periodic Table are numbered from left to right as 1-18  
25 (CRC Handbook of Chemistry and Physics, 81<sup>st</sup> Edition, 2000).

## 2. Chrysene Compound

One aspect of the present invention is a composition of Formula I:

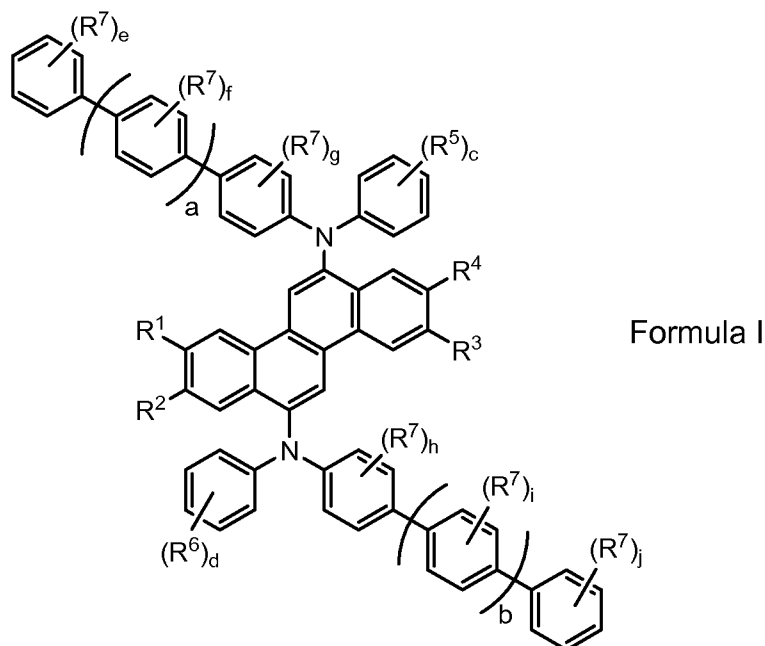

wherein:

5  $R^1$ ,  $R^2$ ,  $R^3$  and  $R^4$  are the same or different and are selected from the group consisting of H and alkyl, where  $R^1$  and  $R^2$  groups or  $R^3$  and  $R^4$  groups may be joined together to form a 5- or 6-membered aliphatic ring;

10  $R^5$  and  $R^6$  are the same or different and are selected from the group consisting of alkyl groups, m-phenyl, o-phenyl, p-phenyl, m-carbazolyl, and p-carbazolyl;

$R^7$  is the same or different at each occurrence and is selected from the group consisting of alkyl groups, phenyl, and biphenyl, or two adjacent  $R^7$  groups can join together to form a naphthyl group;

15 a and b are the same or different and are an integer from 0-10;

c and d are the same or different and are an integer from 1-3;

f, g, h, and i, are the same or different at each occurrence and are an integer from 0-4; and

20 e and j are the same or different at each occurrence and are an integer from 0-5.

The compound is capable of blue or green emission.

In some embodiments,  $R^1$  through  $R^4$  are hydrocarbon alkyl groups. In some embodiments  $R^1$  is a branched hydrocarbon alkyl group and  $R^2$  through  $R^4$  are H. In some embodiments, the branched hydrocarbon alkyl group has from 3-8 carbon atoms. In some embodiments, the branched hydrocarbon alkyl group is a secondary alkyl selected from the group consisting of isopropyl and 2-butyl. In some embodiments, the branched hydrocarbon alkyl group is a tertiary alkyl selected from the group consisting of t-butyl and 2-(2-methyl)-butyl.

In some embodiments,  $R^1$  and  $R^2$  taken together and  $R^3$  and  $R^4$  taken together form a 5- or 6-membered aliphatic ring. In some embodiments, the aliphatic ring is selected from the group consisting of cyclohexyl and cyclopentyl. In some embodiments, the aliphatic ring has one or more alkyl substituents. In some embodiments,  $R^1$  and  $R^2$  taken together form a 5- or 6-membered aliphatic ring and  $R^3$  and  $R^4$  are H.

In some embodiments, each of  $R^1$  through  $R^4$  is H.

In some embodiments,  $R^5$  and  $R^6$  are straight chain or branched alkyl groups. In some embodiments,  $R^5$  and  $R^6$  are straight chain or branched hydrocarbon alkyl groups. In some embodiments,  $R^5$  and  $R^6$  are hydrocarbon alkyl groups having 1-6 carbon atoms. In some embodiments,  $c = d = 1$ , and  $R^5$  and  $R^6$  are at the 4-position. In some embodiments,  $c = d = 2$ , and  $R^5$  and  $R^6$  are at the 2- and 4-positions.

In some embodiments,  $R^5$  and  $R^6$  are aromatic groups selected from the group consisting of o-phenyl, m-phenyl, p-phenyl, m-carbazolyl, and p-carbazolyl groups. By m-carbazolyl is meant the group

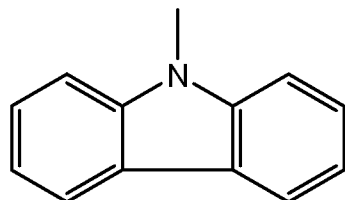

attached to the 3 position of the phenyl ring of the target molecule. By p-carbazolyl is meant the above group attached to the 4 position of the phenyl ring of the target molecule. The aromatic groups may further be substituted with alkyl or phenyl groups.

In some embodiments,  $R^7$  is a hydrocarbon alkyl group having 1-10 carbon atoms. In some embodiments, at least one of e through j is greater than 0. In some embodiments,  $e = f = g = h = i = j = 0$ .

In some embodiments, a and b are 1-10. In some embodiments, a and b are 2-5.

In some embodiments, the chrysene compound is selected from compounds E1 through E17:

E1:

10

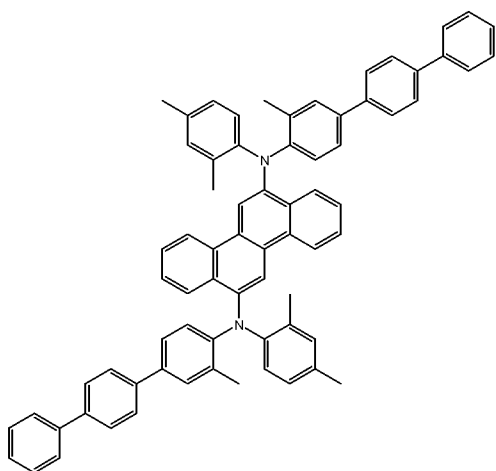

$C_{27}H_{26}N_2$   
Exact Mass: 960.46  
Mol. Wt.: 951.24  
C, 90.91; H, 6.15; N, 2.94

E2:

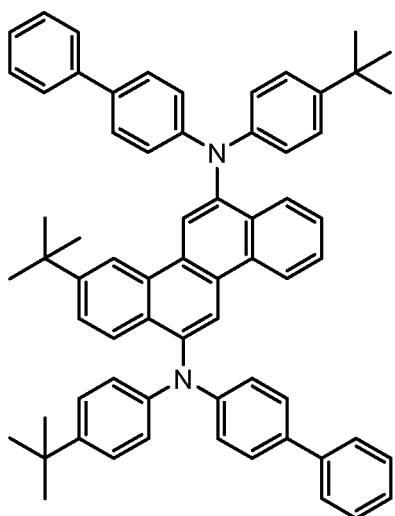

E3:

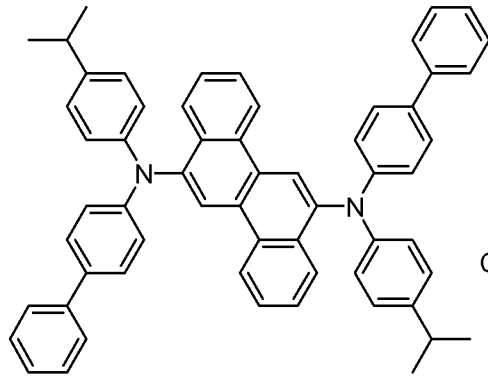

$C_{60}H_{50}N_2$   
 Exact Mass: 798.40  
 Mol. Wt.: 799.05  
 C, 90.19; H, 6.31; N, 3.51

5

E4:

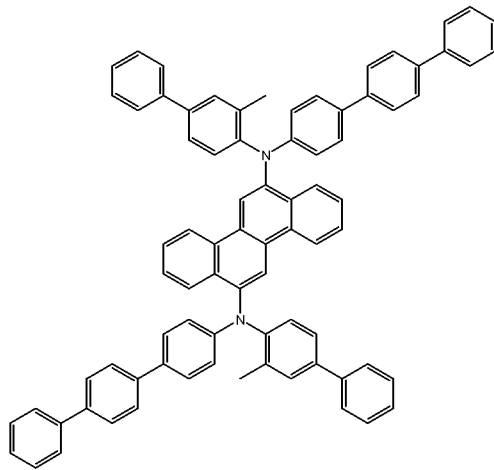

$C_{62}H_{52}N_2$   
 Exact Mass: 1046.46  
 Mol. Wt.: 1047.33  
 C, 91.74; H, 5.58; N, 2.67

10 E5:

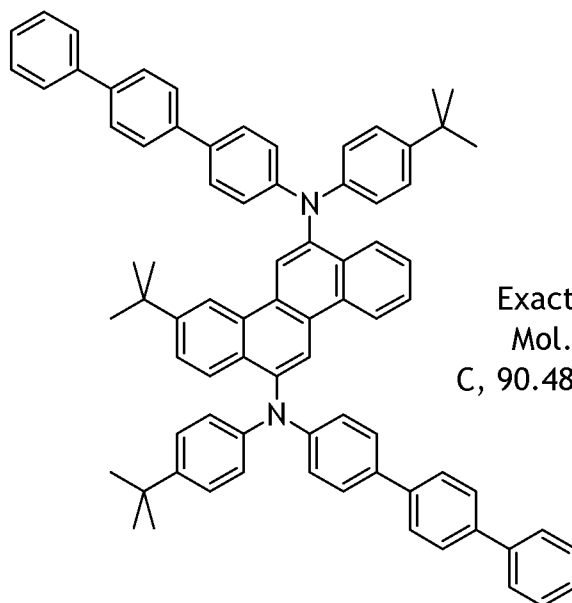

$C_{78}H_{70}N_2$   
 Exact Mass: 1034.55  
 Mol. Wt.: 1035.40  
 C, 90.48; H, 6.81; N, 2.71

E6:

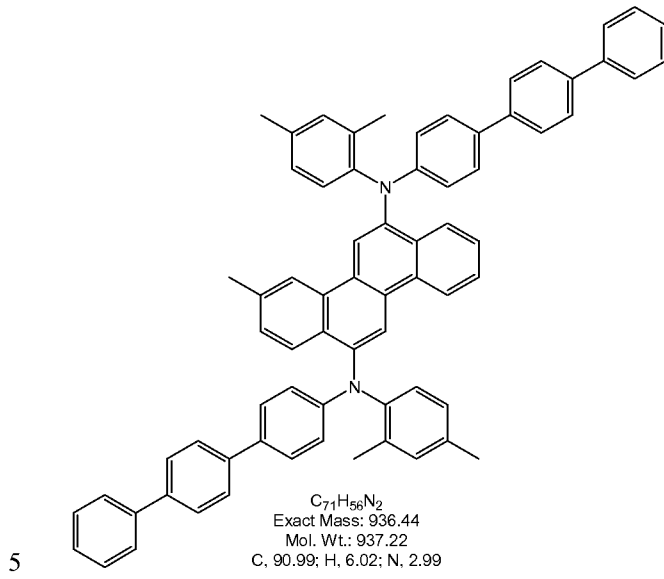

10

15

E7:

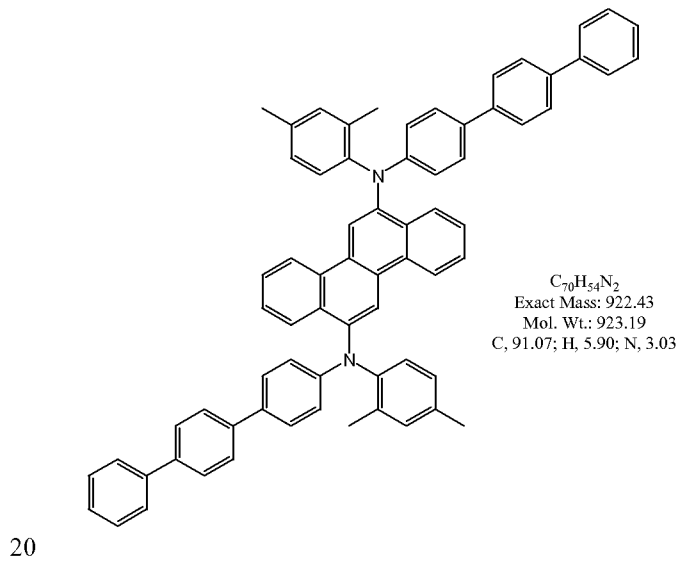

E8:

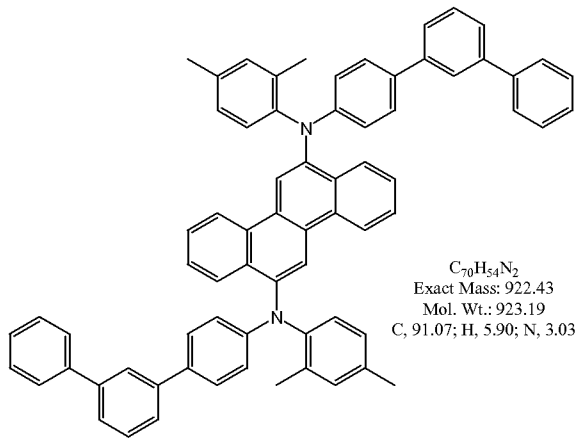

5

E9:

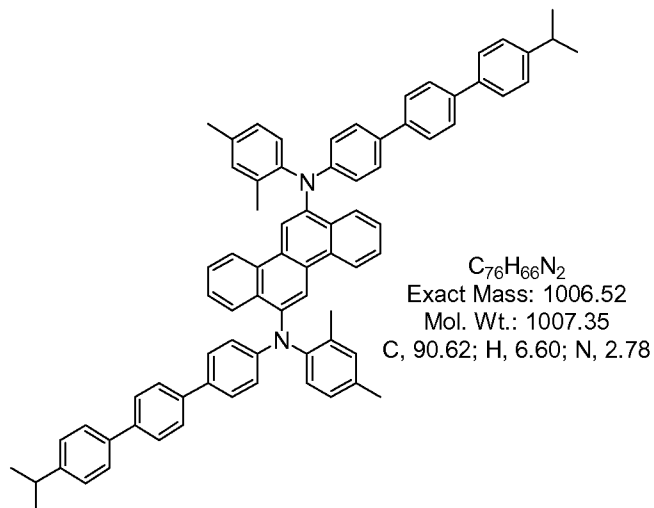

10

E10:

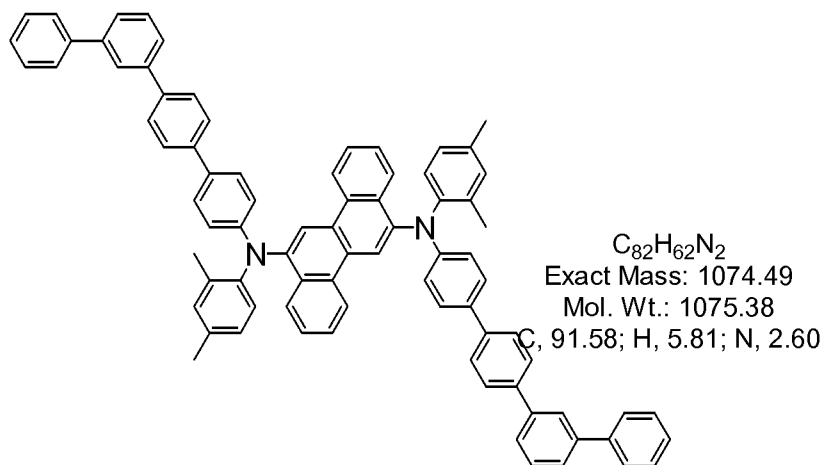

15

E11:

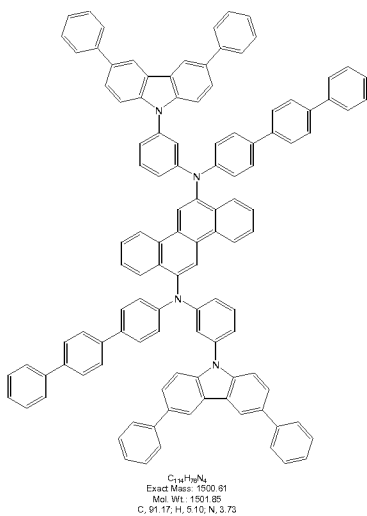

5

10

E12:

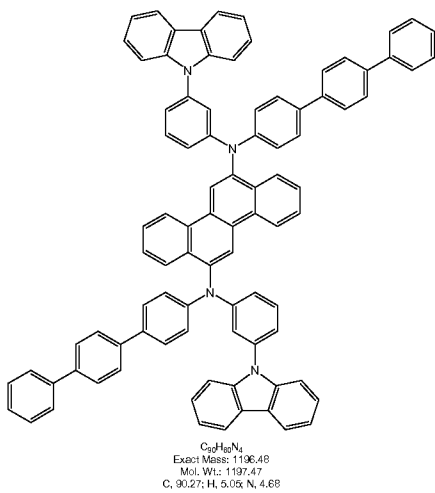

15

E13:

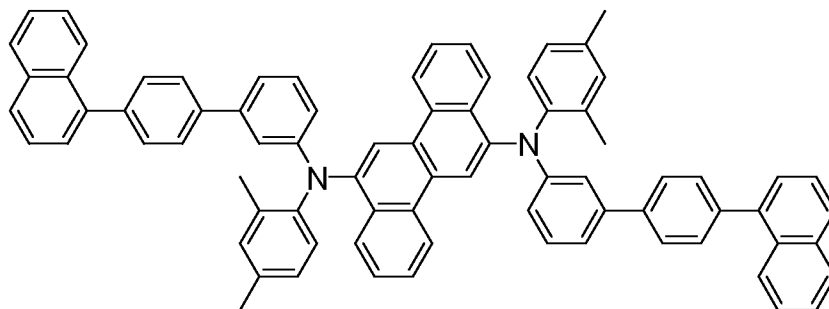

$C_{78}H_{58}N_2$   
Exact Mass: 1022.46  
Mol. Wt.: 1023.31  
C, 91.55; H, 5.71; N, 2.74

5

10

E14:

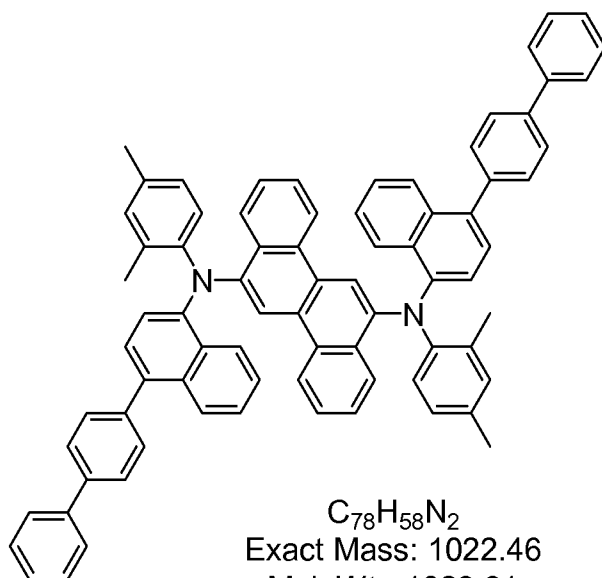

$C_{78}H_{58}N_2$   
Exact Mass: 1022.46  
Mol. Wt.: 1023.31  
C, 91.55; H, 5.71; N, 2.74

E15:

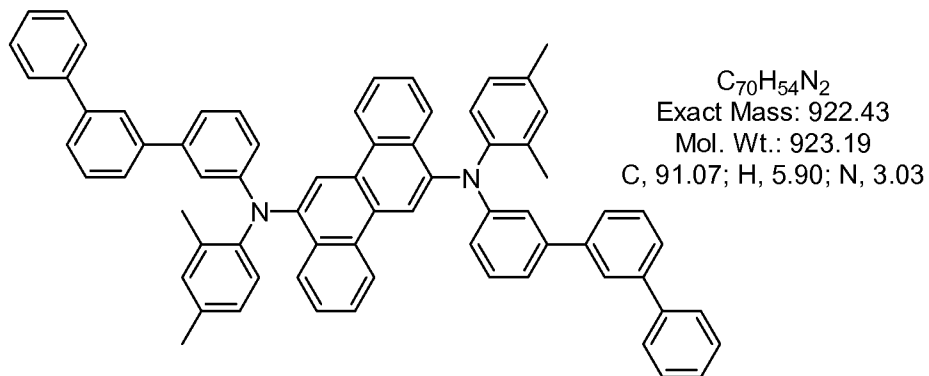

5

E16:

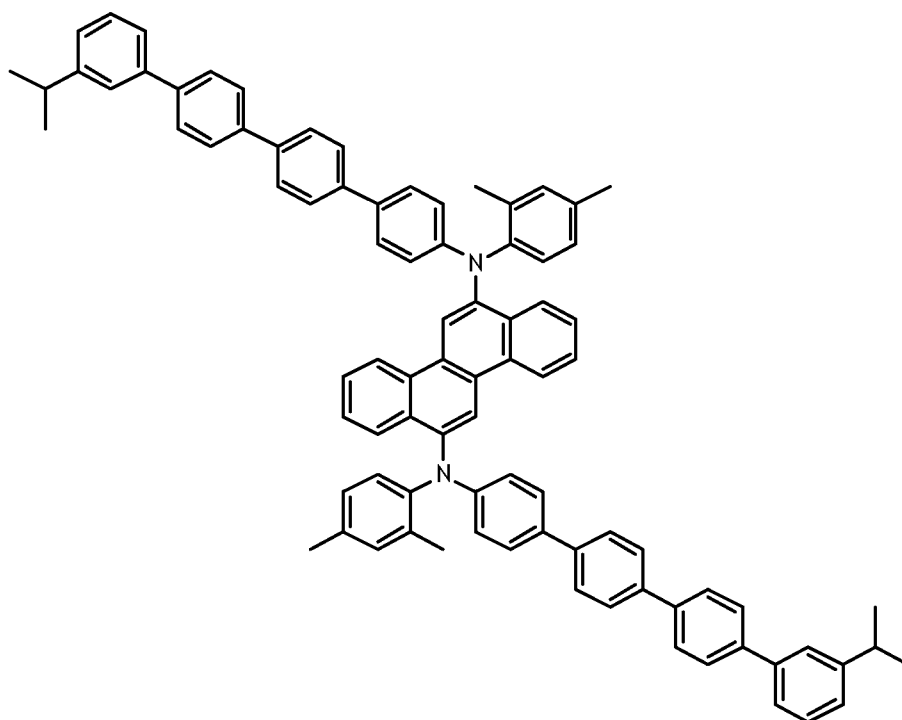

10

E17:

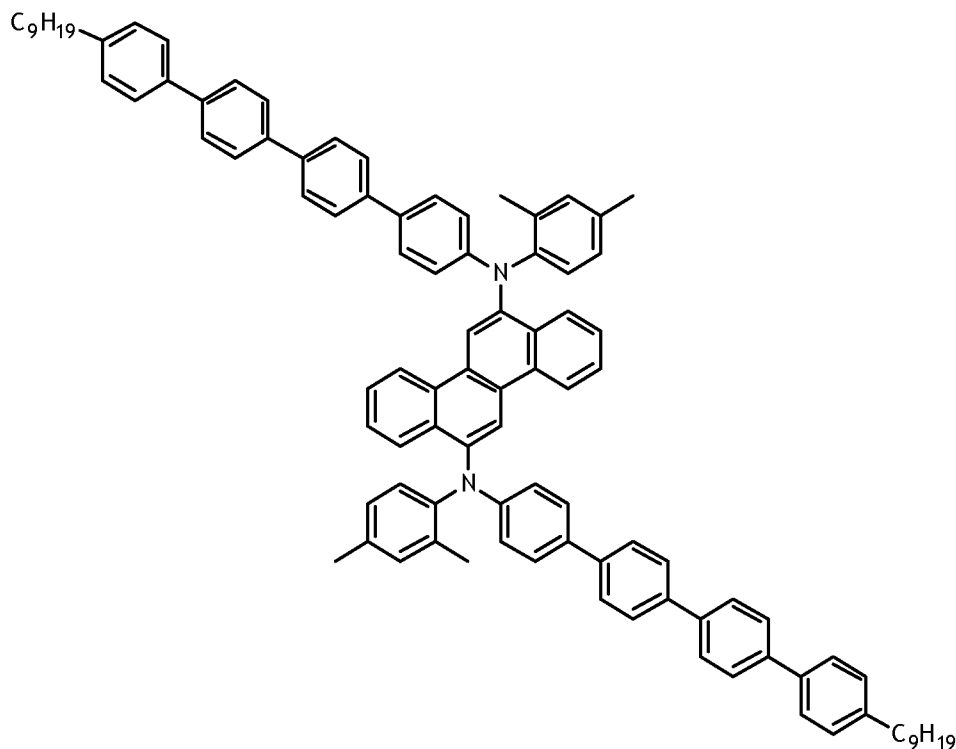

5

The new chrysenes can be prepared by known coupling and substitution reactions. Exemplary preparations are given in the Examples.

The chrysene compounds described herein can be formed into films using liquid deposition techniques. Thin films of these materials dispersed in a host matrix exhibit good to excellent photoluminescent properties and blue or green emission.

The chrysene compounds described herein have a multi-phenyl substituent on the amino nitrogens. The multi-phenyl group can be biphenyl, terphenyl, quaterphenyl, and above. Surprisingly and unexpectedly, these compounds have greatly improved properties when compared to chrysene compounds having only single phenyl substituents on the amino nitrogens. Electronic devices including an active layer with the chrysene compounds described herein, have greatly improved lifetimes. It has been discovered that the lifetime increases with the number of repeat units on the nitrogen substituent. In addition, the lifetime

increases are achieved in combination with high quantum efficiency and good color.

### 3. Electronic Device

5 Organic electronic devices that may benefit from having one or more layers comprising the blue luminescent materials described herein include, but are not limited to, (1) devices that convert electrical energy into radiation (e.g., a light-emitting diode, light emitting diode display, or diode laser), (2) devices that detect signals through electronics processes  
10 (e.g., photodetectors, photoconductive cells, photoresistors, photoswitches, phototransistors, phototubes, IR detectors), (3) devices that convert radiation into electrical energy, (e.g., a photovoltaic device or solar cell), and (4) devices that include one or more electronic components that include one or more organic semi-conductor layers (e.g., a transistor  
15 or diode).

One illustration of an organic electronic device structure is shown in Figure 1. The device 100 has a first electrical contact layer, an anode layer 110 and a second electrical contact layer, a cathode layer 160, and a photoactive layer 140 between them. Adjacent to the anode is a buffer  
20 layer 120. Adjacent to the buffer layer is a hole transport layer 130, comprising hole transport material. Adjacent to the cathode may be an electron transport layer 150, comprising an electron transport material. As an option, devices may use one or more additional hole injection or hole transport layers (not shown) next to the anode 110 and/or one or more  
25 additional electron injection or electron transport layers (not shown) next to the cathode 160.

Layers 120 through 150 are individually and collectively referred to as the active layers.

In one embodiment, the different layers have the following range of  
30 thicknesses: anode 110, 500-5000 Å, in one embodiment 1000-2000 Å; buffer layer 120, 50-2000 Å, in one embodiment 200-1000 Å; hole transport layer 130, 50-2000 Å, in one embodiment 200-1000 Å; photoactive layer 140, 10-2000 Å, in one embodiment 100-1000 Å; layer 150, 50-2000 Å, in one embodiment 100-1000 Å; cathode 160, 200-10000

Å, in one embodiment 300-5000 Å. The location of the electron-hole recombination zone in the device, and thus the emission spectrum of the device, can be affected by the relative thickness of each layer. The desired ratio of layer thicknesses will depend on the exact nature of the materials used.

Depending upon the application of the device 100, the photoactive layer 140 can be a light-emitting layer that is activated by an applied voltage (such as in a light-emitting diode or light-emitting electrochemical cell), or a layer of material that responds to radiant energy and generates a signal with or without an applied bias voltage (such as in a photodetector). Examples of photodetectors include photoconductive cells, photoresistors, photoswitches, phototransistors, and phototubes, and photovoltaic cells, as these terms are described in Markus, John, *Electronics and Nucleonics Dictionary*, 470 and 476 (McGraw-Hill, Inc. 1966).

a. Photoactive layer

The chrysene compounds of Formula I are useful as photoactive materials in layer 140. The compounds can be used alone, or in combination with a host material.

In some embodiments, the host is a bis-condensed cyclic aromatic compound.

In some embodiments, the host is an anthracene derivative compound. In some embodiments the compound has the formula:



where:

An is an anthracene moiety;

L is a divalent connecting group.

In some embodiments of this formula, L is a single bond,  $-\text{O}-$ ,  $-\text{S}-$ ,  $-\text{N}(\text{R})-$ , or an aromatic group. In some embodiments, An is a mono- or diphenylanthryl moiety.

In some embodiments, the host has the formula:



where:

An is an anthracene moiety;

A is the same or different at each occurrence and is an aromatic group.

In some embodiments, the A groups are attached at the 9- and 10-positions of the anthracene moiety. In some embodiments, A is selected from the group consisting naphthyl, naphthylphenylene, and naphthynaphthylene. In some embodiments the compound is symmetrical and in some embodiments the compound is non-symmetrical.

In some embodiments, the host has the formula:

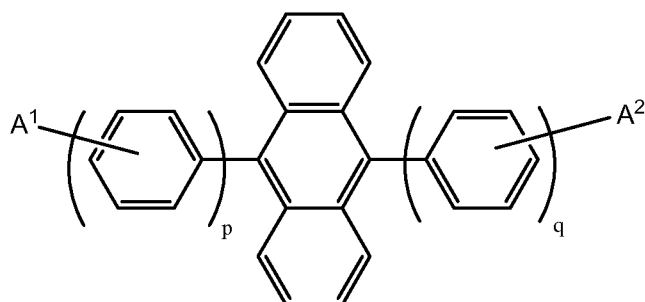

10

where:

$A^1$  and  $A^2$  are the same or different at each occurrence and are selected from the group consisting of H, an aromatic group, and an alkenyl group, or A may represent one or more fused aromatic rings;

15

p and q are the same or different and are an integer from 1-3.

In some embodiments, the anthracene derivative is non-symmetrical. In some embodiments,  $p = 2$  and  $q = 1$ . In some embodiments, at least one of  $A^1$  and  $A^2$  is a naphthyl group.

In some embodiments, the host is selected from the group

20 consisting of

H1

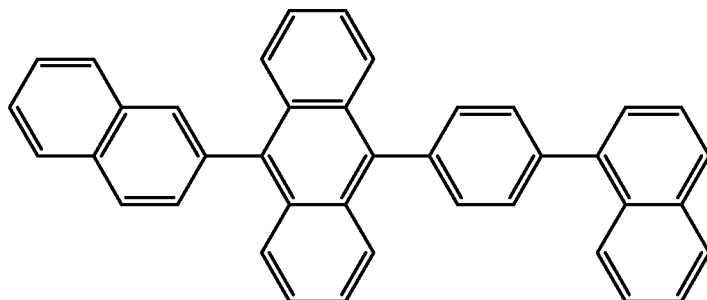

H2

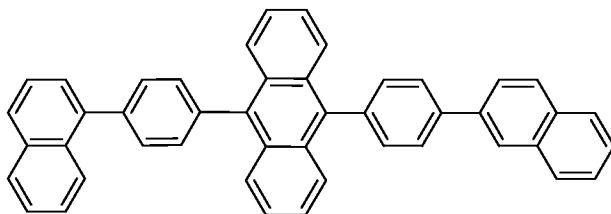

5

and combinations thereof.

The chrysene compounds of Formula I, in addition to being useful as emissive dopants in the photoactive layer, can also act as charge carrying hosts for other emissive dopants in the photoactive layer 140.

b. Other Device Layers

The other layers in the device can be made of any materials that are known to be useful in such layers.

The anode 110, is an electrode that is particularly efficient for injecting positive charge carriers. It can be made of, for example, materials containing a metal, mixed metal, alloy, metal oxide or mixed-metal oxide, or it can be a conducting polymer, or mixtures thereof. Suitable metals include the Group 11 metals, the metals in Groups 4-6, and the Group 8-10 transition metals. If the anode is to be light-transmitting, mixed-metal oxides of Groups 12, 13 and 14 metals, such as indium-tin-oxide, are generally used. The anode 110 can also comprise an organic material such as polyaniline as described in "Flexible light-emitting diodes made from soluble conducting polymer," *Nature* vol. 357, pp 477-479 (11 June 1992). At least one of the anode and cathode is desirably at least partially transparent to allow the generated light to be observed.

The buffer layer 120 comprises buffer material and may have one or more functions in an organic electronic device, including but not limited to, planarization of the underlying layer, charge transport and/or charge injection properties, scavenging of impurities such as oxygen or metal

ions, and other aspects to facilitate or to improve the performance of the organic electronic device. Buffer materials may be polymers, oligomers, or small molecules. They may be vapour deposited or deposited from liquids which may be in the form of solutions, dispersions, suspensions, emulsions, colloidal mixtures, or other compositions.

The buffer layer can be formed with polymeric materials, such as polyaniline (PANI) or polyethylenedioxythiophene (PEDOT), which are often doped with protonic acids. The protonic acids can be, for example, poly(styrenesulfonic acid), poly(2-acrylamido-2-methyl-1-propanesulfonic acid), and the like.

The buffer layer can comprise charge transfer compounds, and the like, such as copper phthalocyanine and the tetrathiafulvalene-tetracyanoquinodimethane system (TTF-TCNQ).

In some embodiments, the buffer layer comprises at least one electrically conductive polymer and at least one fluorinated acid polymer. Such materials have been described in, for example, published U.S. patent applications 2004-0102577, 2004-0127637, and 2005/205860

Examples of hole transport materials for layer 130 have been summarized for example, in Kirk-Othmer Encyclopedia of Chemical Technology, Fourth Edition, Vol. 18, p. 837-860, 1996, by Y. Wang. Both hole transporting molecules and polymers can be used. Commonly used hole transporting molecules are: N,N'-diphenyl-N,N'-bis(3-methylphenyl)-[1,1'-biphenyl]-4,4'-diamine (TPD), 1,1-bis[(di-4-tolylamino)phenyl]cyclohexane (TAPC), N,N'-bis(4-methylphenyl)-N,N'-bis(4-ethylphenyl)-[1,1'-(3,3'-dimethyl)biphenyl]-4,4'-diamine (ETPD), tetrakis-(3-methylphenyl)-N,N,N',N'-2,5-phenylenediamine (PDA), a-phenyl-4-N,N-diphenylaminostyrene (TPS), p-(diethylamino)benzaldehyde diphenylhydrazone (DEH), triphenylamine (TPA), bis[4-(N,N-diethylamino)-2-methylphenyl](4-methylphenyl)methane (MPMP), 1-phenyl-3-[p-(diethylamino)styryl]-5-[p-(diethylamino)phenyl] pyrazoline (PPR or DEASP), 1,2-trans-bis(9H-carbazol-9-yl)cyclobutane (DCZB), N,N,N',N'-tetrakis(4-methylphenyl)-(1,1'-biphenyl)-4,4'-diamine (TTB), N,N'-bis(naphthalen-1-yl)-N,N'-bis-(phenyl)benzidine ( $\alpha$ -NPB), and

porphyrinic compounds, such as copper phthalocyanine. Commonly used hole transporting polymers are polyvinylcarbazole, (phenylmethyl)-polysilane, and polyaniline. It is also possible to obtain hole transporting polymers by doping hole transporting molecules such as those mentioned above into polymers such as polystyrene and polycarbonate. In some cases, triarylamine polymers are used, especially triarylamine-fluorene copolymers. In some cases, the polymers and copolymers are crosslinkable.

Examples of additional electron transport materials which can be used in layer 150 include metal chelated oxinoid compounds, such as tris(8-hydroxyquinolato)aluminum ( $\text{Alq}_3$ ); bis(2-methyl-8-quinolinolato)(para-phenyl-phenolato)aluminum(III) (BAIQ); and azole compounds such as 2-(4-biphenyl)-5-(4-t-butylphenyl)-1,3,4-oxadiazole (PBD) and 3-(4-biphenyl)-4-phenyl-5-(4-t-butylphenyl)-1,2,4-triazole (TAZ), and 1,3,5-tri(phenyl-2-benzimidazole)benzene (TPBI); quinoxaline derivatives such as 2,3-bis(4-fluorophenyl)quinoxaline; phenanthroline derivatives such as 9,10-diphenylphenanthroline (DPA) and 2,9-dimethyl-4,7-diphenyl-1,10-phenanthroline (DDPA); and mixtures thereof. Layer 150 can function both to facilitate electron transport, and also serve as a buffer layer or confinement layer to prevent quenching of the exciton at layer interfaces. Preferably, this layer promotes electron mobility and reduces exciton quenching.

The cathode 160, is an electrode that is particularly efficient for injecting electrons or negative charge carriers. The cathode can be any metal or nonmetal having a lower work function than the anode. Materials for the cathode can be selected from alkali metals of Group 1 (e.g., Li, Cs), the Group 2 (alkaline earth) metals, the Group 12 metals, including the rare earth elements and lanthanides, and the actinides. Materials such as aluminum, indium, calcium, barium, samarium and magnesium, as well as combinations, can be used. Li-containing organometallic compounds, LiF, and  $\text{Li}_2\text{O}$  can also be deposited between the organic layer and the cathode layer to lower the operating voltage.

It is known to have other layers in organic electronic devices. For example, there can be a layer (not shown) between the anode 110 and buffer layer 120 to control the amount of positive charge injected and/or to provide band-gap matching of the layers, or to function as a protective layer. Layers that are known in the art can be used, such as copper phthalocyanine, silicon oxy-nitride, fluorocarbons, silanes, or an ultra-thin layer of a metal, such as Pt. Alternatively, some or all of anode layer 110, active layers 120, 130, 140, and 150, or cathode layer 160, can be surface-treated to increase charge carrier transport efficiency. The choice of materials for each of the component layers is preferably determined by balancing the positive and negative charges in the emitter layer to provide a device with high electroluminescence efficiency.

It is understood that each functional layer can be made up of more than one layer.

The device can be prepared by a variety of techniques, including sequential vapor deposition of the individual layers on a suitable substrate. Substrates such as glass, plastics, and metals can be used. Conventional vapor deposition techniques can be used, such as thermal evaporation, chemical vapor deposition, and the like. Alternatively, the organic layers can be applied from solutions or dispersions in suitable solvents, using conventional coating or printing techniques, including but not limited to spin-coating, dip-coating, roll-to-roll techniques, ink-jet printing, screen-printing, gravure printing and the like.

The present invention also relates to an electronic device comprising at least one active layer positioned between two electrical contact layers, wherein the at least one active layer of the device includes the chrysene compound of Formula 1. Devices frequently have additional hole transport and electron transport layers.

To achieve a high efficiency LED, the HOMO (highest occupied molecular orbital) of the hole transport material desirably aligns with the work function of the anode, and the LUMO (lowest un-occupied molecular orbital) of the electron transport material desirably aligns with the work function of the cathode. Chemical compatibility and sublimation

temperature of the materials are also important considerations in selecting the electron and hole transport materials.

It is understood that the efficiency of devices made with the chrysene compounds described herein, can be further improved by optimizing the other layers in the device. For example, more efficient cathodes such as Ca, Ba or LiF can be used. Shaped substrates and novel hole transport materials that result in a reduction in operating voltage or increase quantum efficiency are also applicable. Additional layers can also be added to tailor the energy levels of the various layers and facilitate electroluminescence.

The chrysene compounds of the invention often are fluorescent and photoluminescent and can be useful in applications other than OLEDs, such as oxygen sensitive indicators and as fluorescent indicators in bioassays.

#### EXAMPLES

The following examples illustrate certain features and advantages of the present invention. They are intended to be illustrative of the invention, but not limiting. All percentages are by weight, unless otherwise indicated.

##### Example 1

This example illustrates the preparation of Compound E1. Take 0.39g of the dibromochrysene (1 mM) in glove box and add 0.75g (2.1mM) sec amine and 0.22g t-BuONa (2.2mM) with 10mL toluene. Add 0.15g Pd2DBA3 (0.15mM), 0.06g P(t-Bu)3 (0.30mM). Mix and heat in glove box in mantle at 110C under nitrogen for 1hr. Solution immediately is dark purple but on reaching ~80C it is dark purple brown with noticeable blue luminescence. Warm at ~RT overnight. Cool and work up by removing from glove box and filter through a b-alumina/silica/florisil plug eluting with toluene. Product is pale yellow and quite soluble. The blue luminescent material elutes from the column as a pale yellow solution. Evaporate to low volume and add methanol to ppt yellow solid with blue PL in ~0.5g yield. TLC shows single blue spot running at the solvent front in toluene. Material is very soluble in toluene

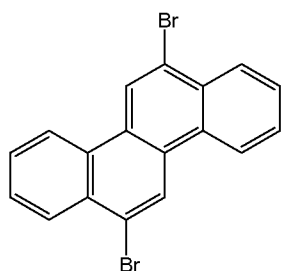

$C_{18}H_{10}Br_2$   
 Exact Mass: 383.91  
 Mol. Wt.: 386.08  
 C, 56.00; H, 2.61; Br, 41.39

Product:

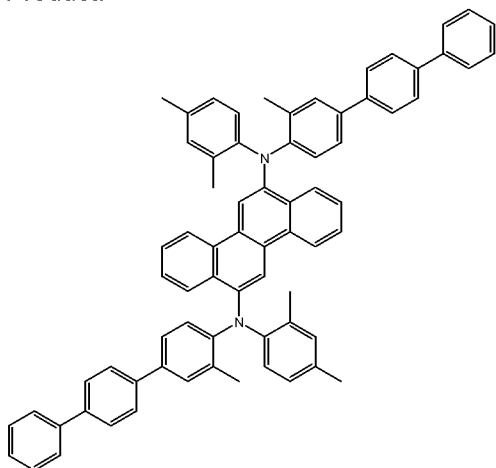

$C_{72}H_{58}N_2$   
 Exact Mass: 950.46  
 Mol. Wt.: 951.24  
 C, 90.91; H, 6.15; N, 2.94

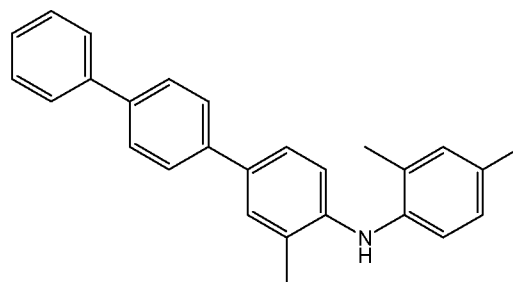

$C_{27}H_{25}N$   
 Exact Mass: 363.20  
 Mol. Wt.: 363.49  
 C, 89.21; H, 6.93; N, 3.85

## 5 Example 2

This example illustrates the preparation of Compound E2,  $N^6,N^{12}$ -di(biphenyl-4-yl)-3-*tert*-butyl- $N^6,N^{12}$ -bis(4-*tert*-butylphenyl)chrysen-6,12-diamine.

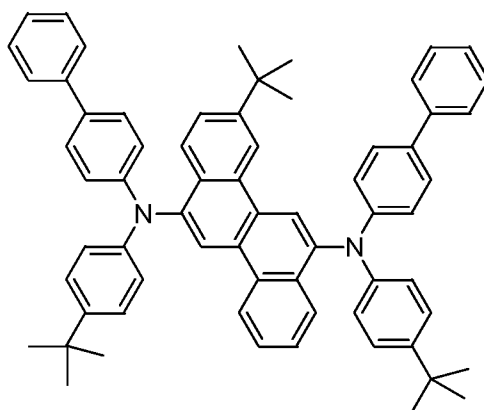

10

In a drybox, 3-*tert*-butyl-6,12-dibromochrysen (1.8 g, 4.07 mmol) and *N*-(4-*tert*-butylphenyl)biphenyl-4-amine (2.58 g, 8.55 mmol) were combined in a thick-walled glass tube and dissolved in 20 ml of dry

toluene. Tris(*tert*-butyl)phosphine (0.0148 g, 0.073 mmol) and tris(dibenzylideneacetone) dipalladium(0) (0.0335 g, 0.0366 mmol) were dissolved in 10 ml of dry toluene and stirred for 10 minutes. The catalyst solution was added to the reaction mixture, stirred for 10 minutes and followed by sodium *tert*-butoxide (0.782 g, 8.14 mmol) and 20 ml of dry toluene. After another 10 minutes, the reaction flask was brought out of the drybox, attached to a nitrogen line and stirred at 80 °C overnight. Next day, reaction mixture was cooled to room temperature and filtered through a 4 inch plug of silica gel and one inch of celite, washing with one liter of chloroform and 300 ml of dichloromethane. Removal of volatiles under reduced pressure gave a yellow solid. The crude product was purified further by silica gel column chromatography using a gradient of dichloromethane in hexanes (10 % to 15 %). Removal of volatiles yielded 3.25 g (90.5 %) of product as a yellow solid. <sup>1</sup>H NMR (CD<sub>2</sub>Cl<sub>2</sub>): δ 1.22 (s, 9H), 1.23 (s, 9H), 1.31 (s, 9H), 7.04-7.56 (m, 29 H), 8.00 (d, 1H, J = 8.8 Hz), 8.07 (dd, 1H, J = 1.1, 8.3 Hz), 8.44 (d, 1H, J = 1.8 Hz), 8.51 (s, 1H), 8.53 (s, 1H), 8.54 (d, 1H, J = 8.3 Hz).

### Example 3

This example illustrates the preparation of Compound E4. Take 0.39g of the dibromochrysene (1 mM) in glove box and add 0.88g (2.1mM) sec amine (100555-201) and 0.22g t-BuONa (2.2mM) with 10mL toluene. Add 0.15g Pd2DBA3 (0.15mM), 0.06g P(t-Bu)3 (0.30mM) dissolved in xylenes. Mix and heat in glove box in mantle at 110C under nitrogen for 1hr. Solution immediately is dark purple but on reaching ~80C it is dark yellow brown with noticeable blue luminescence. Warm at ~80C overnight. Cool and work up by removing from glove box and filter through a b-alumina/silica/florisil plug eluting with toluene. Product is pale yellow and poorly soluble. The blue luminescent material elutes from the column as a pale yellow solution. Evaporate to low volume and add methanol to ppt yellow solid with blue PL in ~0.3g yield. Material is modestly soluble in toluene

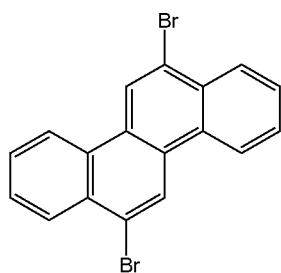

$C_{18}H_{10}Br_2$   
 Exact Mass: 383.91  
 Mol. Wt.: 386.08  
 C, 56.00; H, 2.61; Br, 41.39

Product:

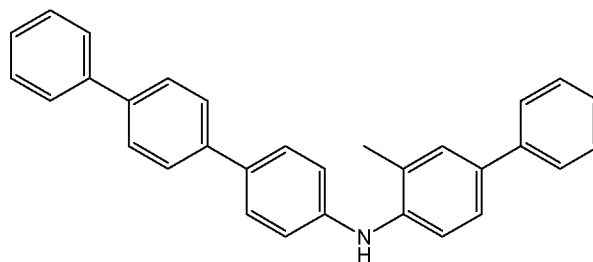

$C_{31}H_{25}N$   
 Exact Mass: 411.20  
 Mol. Wt.: 411.54  
 C, 90.47; H, 6.12; N, 3.40

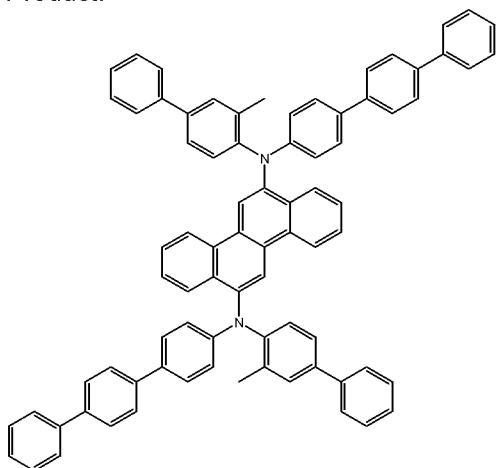

$C_{60}H_{39}N_2$   
 Exact Mass: 1046.46  
 Mol. Wt.: 1047.33  
 C, 91.74; H, 5.58; N, 2.67

5

#### Example 4

This example illustrates the preparation of Compound E5.

In a drybox,  $Pd_2(dba)_3$  ( ) and  $P(tert-Bu)_3$  ( ) were dissolved in 3 ml of dry toluene and set aside for five minutes. 6,12-Dibromochrysene ( ) and N-(4-  
 10 *tert*-butylphenyl)-4,4' terphenylamine ( ) were combined in the reaction flask and dissolved in dry toluene (25 ml). Pre-formed catalyst solution was added next, reaction mixture was stirred for three minutes, followed by the addition of sodium *tert*-butoxide ( ). Reaction was stirred at 100 °C  
 15 for 16 hours. Reaction mixture was filtered through a plug of silica and Celite. The silica/Celite plug was washed with 300 ml of  $CH_2Cl_2$ . Filtrates were combined and evaporated to dryness using rotary evaporator. The crude product was purified by column chromatography twice. First, on alumina column with 20%  $CH_2Cl_2$  in hexanes to get rid of unreacted diarylamine and, second, on silica gel (silica gel 60, 230-400 mesh from  
 20 EMD, 15%  $CH_2Cl_2$  in hexanes, monitored by TLC, same solvent system,

$R_f(\text{product})=0.09$ ,  $R_f(\text{impurity})=0.18$ . Yield 450 mg (38%) of yellow solid.  
Analysis by  $^1\text{H}$  NMR indicated that the product was Compound E5.

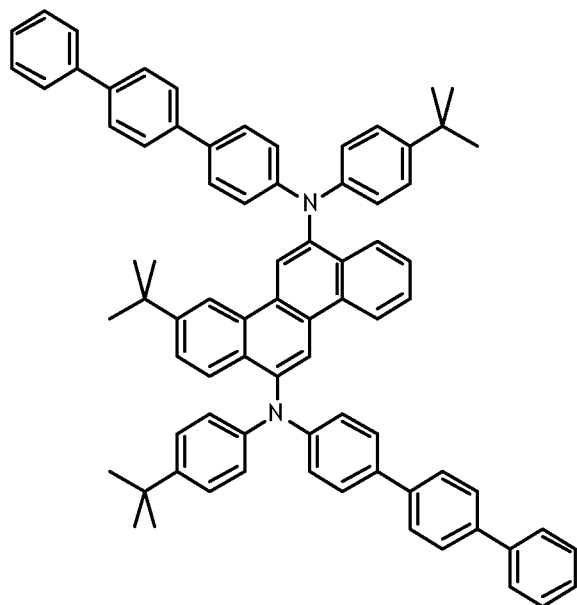

5

### Example 5

This example illustrates the preparation of Compound E6.

Take 0.39g of the dibromo-methylchrysene (1 mM) in glove box and add 0.75g (2.1mM) sec amine and 0.22g t-BuONa (2.2mM) with 10mL toluene.

10 Add 0.15g Pd2DBA3 (0.15mM), 0.06g P(t-Bu)3 (0.30mM) dissolved in toluene. Mix and heat in glove box in mantle at 80C under nitrogen for 1hr. Solution immediately is dark purple but on reaching ~80C it is dark yellow brown with noticeable blue luminescence. Cool and work up by removing from glove box and filter through a b-alumina/silica/florisil plug

15 eluting with toluene. Product is pale yellow and nicely soluble. The blue luminescent material elutes from the column as a pale yellow solution. Evaporate to low volume and add methanol to ppt yellow solid with blue PL in ~0.5g yield. TLC shows single blue spot running at the solvent front in toluene. Material is soluble in toluene

20

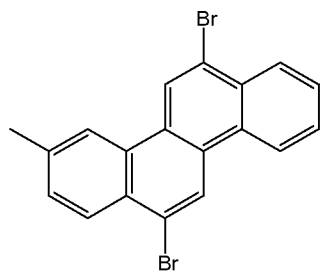

$C_{19}H_{12}Br_2$   
 Exact Mass: 397.93  
 Mol. Wt.: 400.11  
 C, 57.04; H, 3.02; Br, 39.94

Product:

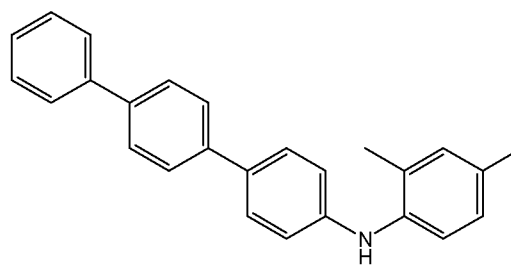

$C_{26}H_{23}N$   
 Exact Mass: 349.18  
 Mol. Wt.: 349.47  
 C, 89.36; H, 6.63; N, 4.01

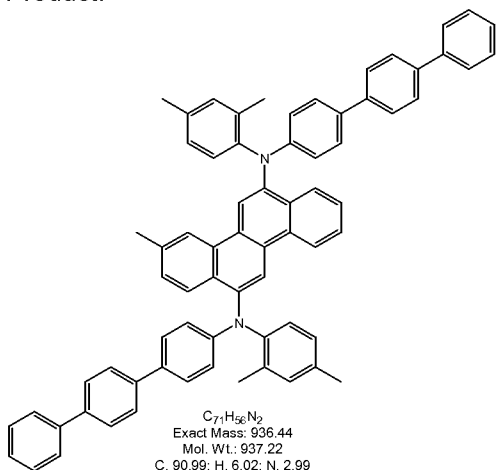

$C_{71}H_{52}N_2$   
 Exact Mass: 936.44  
 Mol. Wt.: 937.22  
 C, 90.99; H, 6.02; N, 2.99

5

### Example 6

This example illustrates the preparation of Compound E7.

Take 0.39g of the dibromochrysenes (1 mM) in glove box and add 0.75g (2.1mM) sec amine and 0.22g t-BuONa (2.2mM) with 10mL toluene. Add  
 10 0.15g Pd2DBA3 (0.15mM), 0.06g P(t-Bu)3 (0.30mM) dissolved in xylenes. Mix and heat in glove box in mantle at 110C under nitrogen for 1hr. Solution immediately is dark purple but on reaching ~80C it is dark yellow brown with noticeable blue luminescence. Warm at ~80C overnight. Cool and work up by removing from glove box and filter through a b-  
 15 alumina/silica/florisil plug eluting with toluene. Product is pale yellow and poorly soluble. The blue luminescent material elutes from the column as a pale yellow solution. Evaporate to low volume and add methanol to ppt yellow solid with blue PL in ~0.5g yield. TLC shows single blue spot running at the solvent front in toluene. Material is modestly soluble in  
 20 toluene

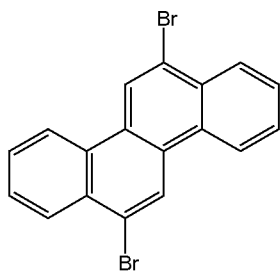

$C_{18}H_{10}Br_2$   
 Exact Mass: 383.91  
 Mol. Wt.: 386.08  
 C, 56.00; H, 2.61; Br, 41.39

Product:

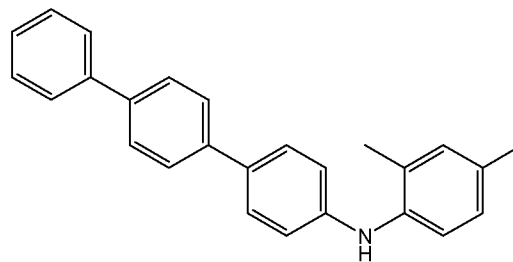

$C_{26}H_{23}N$   
 Exact Mass: 349.18  
 Mol. Wt.: 349.47  
 C, 89.36; H, 6.63; N, 4.01

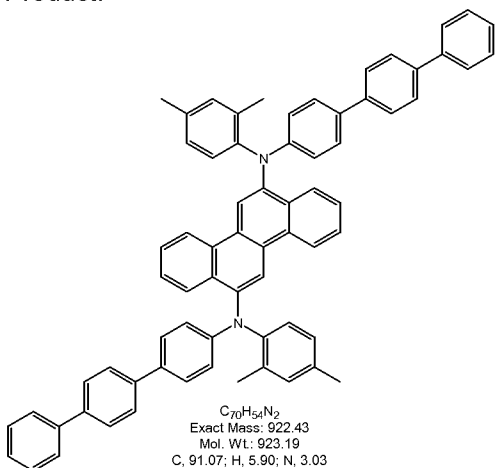

$C_{70}H_{54}N_2$   
 Exact Mass: 922.43  
 Mol. Wt.: 923.19  
 C, 91.07; H, 5.90; N, 3.03

5

### Example 7

This example illustrates the preparation of Compound E8.

Take 0.39g of the dibromochrysenes (1 mM) in glove box and add 0.75g (2.1mM) sec amine and 0.22g t-BuONa (2.2mM) with 10mL toluene. Add  
 10 0.15g Pd2DBA3 (0.15mM), 0.06g P(t-Bu)3 (0.30mM) dissolved in toluene. Mix and heat in glove box in mantle at 110C under nitrogen for 1hr. Solution immediately is dark purple but on reaching ~80C it is dark yellow brown with noticeable blue luminescence. Warm at ~80C overnight. Cool and work up by removing from glove box and filter through a b-  
 15 alumina/florisil plug eluting with toluene. Product is pale yellow and quite soluble. The blue luminescent material elutes from the column as a pale yellowgreen solution. Evaporate to low volume and add methanol to ppt yellow solid with blue PL in ~0.5g yield. TLC shows single blue spot running at the solvent front in toluene. Material is very soluble in toluene

20

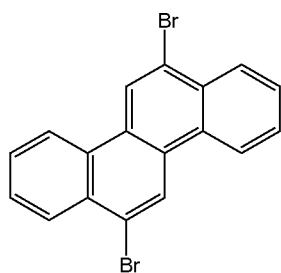

$C_{18}H_{10}Br_2$   
 Exact Mass: 383.91  
 Mol. Wt.: 386.08  
 C, 56.00; H, 2.61; Br, 41.39

Product:

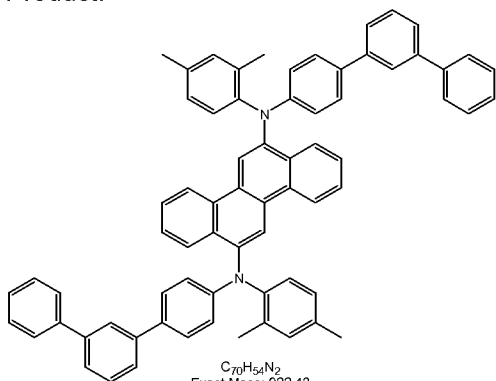

$C_{70}H_{54}N_2$   
 Exact Mass: 922.43  
 Mol. Wt.: 923.19  
 C, 91.07; H, 5.90; N, 3.03

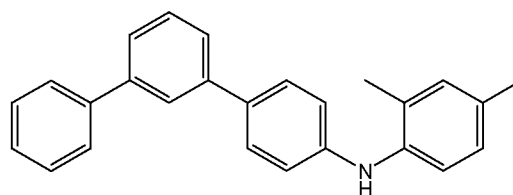

$C_{26}H_{23}N$   
 Exact Mass: 349.18  
 Mol. Wt.: 349.47  
 C, 89.36; H, 6.63; N, 4.01

5

### Example 8

This example illustrates the preparation of Compound E9, N6,N12-bis(2,4-dimethylphenyl)-N6,N12-bis(4'-isopropylterphenyl-4-yl)chrysene-6,12-diamine

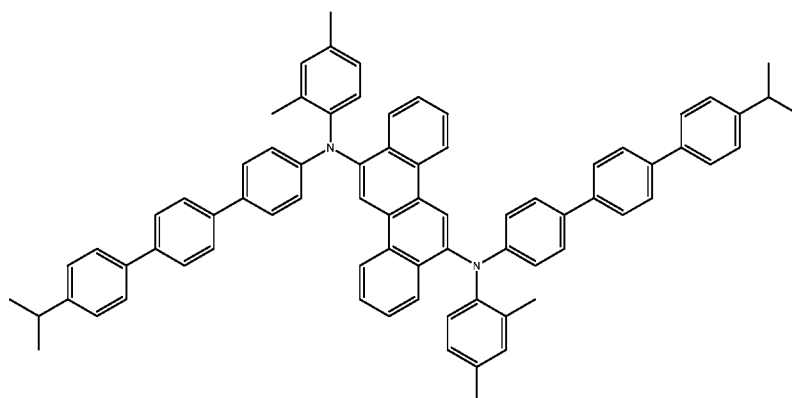

10

In a drybox, 6,12-dibromochrysene (0.54 g, 1.38 mmol), N-(2,4-dimethylphenyl)-N-(4'-isopropylterphenyl-4-yl)amine (1.11 g, 2.82 mmol), tris(*tert*-butyl)phosphine (0.028 g, 0.14 mmol) and

15 tris(dibenzylideneacetone) dipalladium(0) (0.063 g, 0.069 mmol) were combined in round bottom flask and dissolved in 20 ml of dry toluene.

The solution was stirred for a minute and followed by sodium *tert*-butoxide (0.29 g, 3.03 mmol) and 10 ml of dry toluene. A heating mantle was added and the reaction heated to 60C for 3 days. The reaction mixture was then cooled to room temperature and filtered through a 1 inch plug of silica gel and one inch of celite, washing with toluene (500 mL). Removal of volatiles under reduced pressure gave a yellow solid. The crude product was purified further by silica gel column chromatography using a gradient of chloroform in hexanes (0 % to 40 %). Recrystallization from DCM and acetonitrile yielded 0.540 g (40%) of product as a yellow solid.

<sup>1</sup>H NMR (CDCl<sub>3</sub>) is consistent with structure.

### Example 9

This example illustrates the preparation of Compound E11.

Take 0.386g of the dibromochrysene (1.0 mM) in glove box and add 1.35g (2.1mM) sec amine and 0.22g t-BuONa (2.2mM) with 10mL xylene. Add 0.15g Pd2DBA3 (0.15mM), 0.06g P(t-Bu)3 (0.30mM) dissolved in xylenes. Mix and heat in glove box in mantle at 110C under nitrogen for 1hr. Solution immediately is dark purple but on reaching ~80C it is light yellow brown with noticeable blue luminescence. Warm at ~80C for 1hr.

Cool and work up by removing from glove box and filter through a  $\alpha$ -alumina plug eluting with DCM. Product is pale yellow and poorly soluble in toluene. Chromatograph on a  $\beta$ -alumina/florisil column eluting with toluene/DCM. The blue luminescent material elutes from the column as a pale yellow solution. Evaporate to low volume and add methanol to ppt yellow solid with blue PL in ~0.5g yield. Material is poorly soluble in toluene

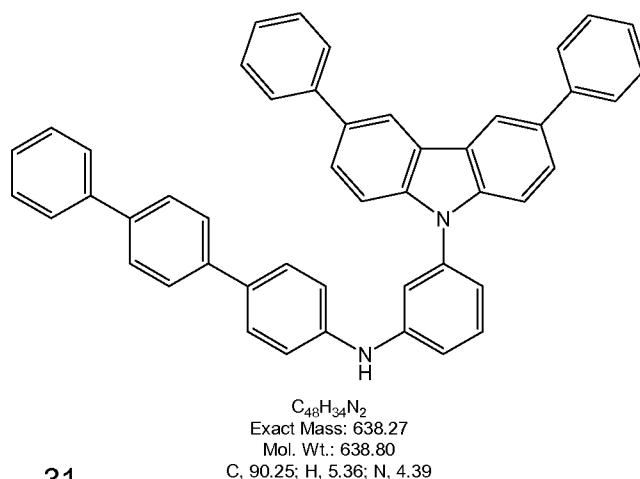
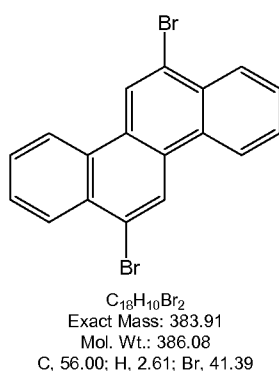

Product:

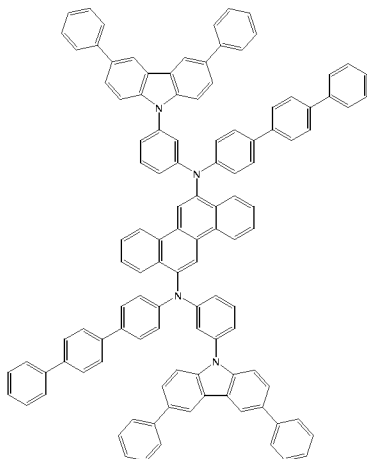

$C_{34}H_{26}N_2$   
 Exact Mass: 486.21  
 Mol. Wt.: 486.61  
 C, 88.86; H, 5.39; N, 5.76

### 5 Example 10

This example illustrates the preparation of Compound E12.

Take 0.39g of the dibromochrysene (1 mM) in glove box and add 1.00g (2.1mM) sec amine (100555-202) and 0.22g t-BuONa (2.2mM) with 10mL xylenes. Add 0.15g Pd2DBA3 (0.15mM), 0.06g P(t-Bu)3 (0.30mM)

10 dissolved in xylenes. Mix and heat in glove box in mantle at 110C under nitrogen for 1hr. Solution immediately is dark purple but on reaching ~80C it is dark yellow brown with noticeable blue luminescence. Cool and work up by removing from glove box and filter through a basic-  
 alumina/silica/florisil plug eluting with DCM. Product is pale yellow and  
 15 very poorly soluble. The blue luminescent material elutes from the column as a pale yellow solution. Evaporate to low volume and add methanol to ppt pale yellow solid with blue PL in ~0.3g yield. . Material is poorly soluble in toluene

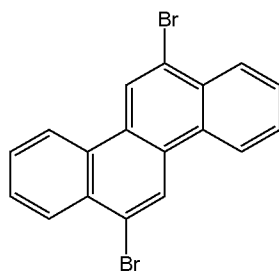

$C_{18}H_{10}Br_2$   
 Exact Mass: 383.91  
 Mol. Wt.: 386.08  
 C, 56.00; H, 2.61; Br, 41.39

20

Product:

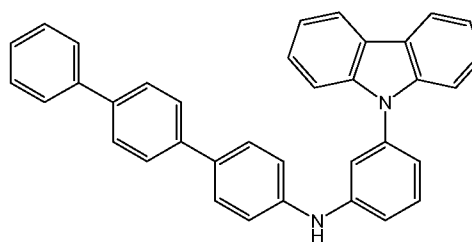

$C_{35}H_{26}N_2$   
 Exact Mass: 486.21  
 Mol. Wt.: 486.61  
 C, 88.86; H, 5.39; N, 5.76

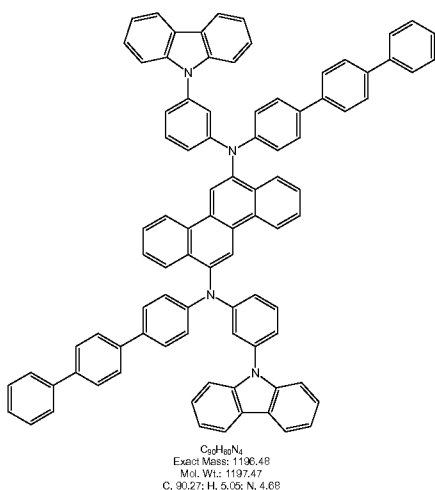

### Example 11

- 5 This example illustrates the preparation of Compound E13, N6,N12-bis(2,4-dimethylphenyl)-N6,N12-bis(4'-(naphthalen-1-yl)biphenyl-4-yl)chrysene-6,12-diamine.

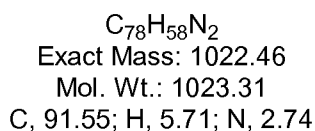
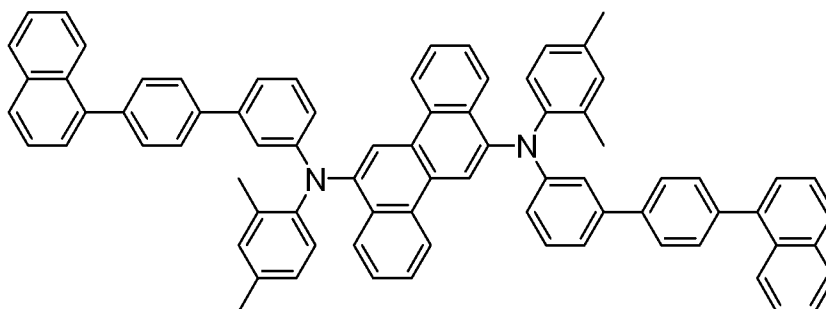

- 10 In a drybox, 6,12-dibromochrysene (0.27 g, 0.69 mmol), N-(2,4-dimethylphenyl)-N-(4'-(naphthalen-1-yl)biphenyl-4-yl)amine (0.60 g, 1.41 mmol), tris(*tert*-butyl)phosphine (0.042 g, 0.21 mmol) and tris(dibenzylideneacetone) dipalladium(0) (0.094 g, 0.103 mmol) were combined in round bottom flask and dissolved in 20 ml of dry toluene.
- 15 The solution was stirred for a minute and followed by sodium *tert*-butoxide (0.145 g, 1.51 mmol) and 10 ml of dry toluene. A heating mantle was added and the reaction heated to 60C for 18 hours. The reaction mixture was then cooled to room temperature and filtered through a 1 inch plug of

silica gel and one inch of celite, washing with toluene (500 mL). Removal of volatiles under reduced pressure gave a yellow solid. The crude product was purified further by silica gel column chromatography using a gradient of chloroform in hexanes (0 % to 20 %). Recrystallization from DCM and acetonitrile yielded 0.400 g (60%) of product as a yellow solid.  
5  $^1\text{H}$  NMR ( $\text{CDCl}_3$ ) is consistent with structure.

### Example 12

This example illustrates the preparation of Compound E14,  
10 N6,N12-bis(4-(biphenyl-4-yl)naphthalen-1-yl)-N6,N12-bis(2,4-dimethylphenyl)chrysene-6,12-diamine.

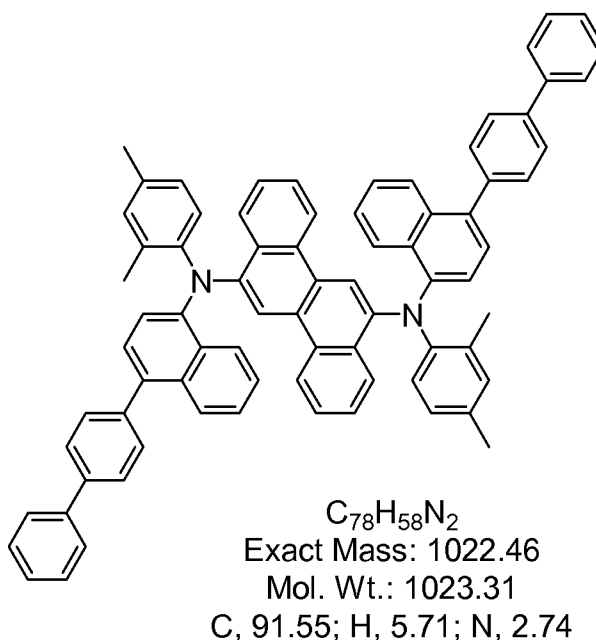

In a drybox, 6,12-dibromochrysene (0.39 g, 1.01 mmol), N-(2,4-dimethylphenyl)-N-(4-(biphenyl-4-yl)naphthalen-1-yl)amine (0.84 g, 2.11 mmol), tris(*tert*-butyl)phosphine (0.061 g, 0.303 mmol) and tris(dibenzylideneacetone) dipalladium(0) (0.138 g, 0.151 mmol) were combined in round bottom flask and dissolved in 25 ml of dry toluene. The solution was stirred for a minute and followed by sodium *tert*-butoxide (0.21 g, 2.22 mmol) and 10 ml of dry toluene. A heating mantle was added and the reaction heated to 60C for 3 days. The reaction mixture was then cooled to room temperature and filtered through a 1 inch plug of silica gel and one inch of celite, washing with toluene (500 mL). Removal  
20

of volatiles under reduced pressure gave a yellow solid. The crude product was purified further by silica gel column chromatography using a gradient of chloroform in hexanes (0 % to 50 %). Recrystallization from DCM and acetonitrile yielded 0.170 g (20%) of product as a yellow solid.

5  $^1\text{H}$  NMR ( $\text{CDCl}_3$ ) is consistent with structure.

### Example 13

This example illustrates the preparation of Compound E15, N6,N12-bis(4-(biphenyl-3-yl)phenyl-2-yl) -N6,N12-bis(2,4-  
10 dimethylphenyl)chrysene-6,12-diamine.

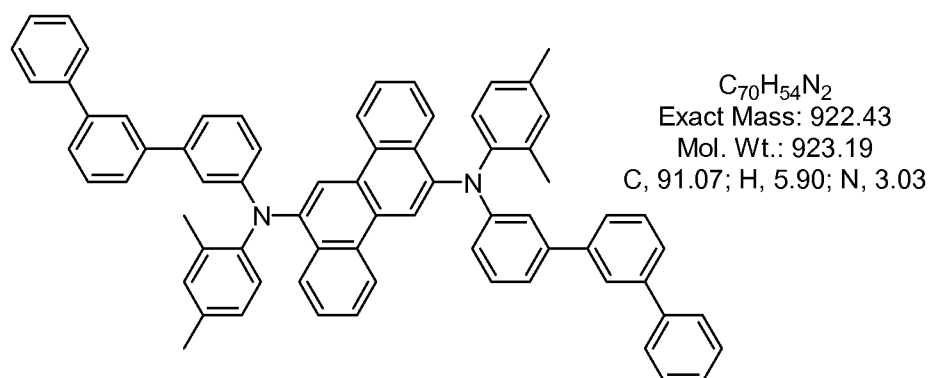

In a drybox, 6,12-dibromochrysene (0.68 g, 1.75 mmol), N-(2,4-dimethylphenyl)-N-(4-(biphenyl-3-yl)phenyl-2-yl)amine (1.35 g, 3.67  
15 mmol), tris(*tert*-butyl)phosphine (0.035 g, 0.175 mmol) and tris(dibenzylideneacetone) dipalladium(0) (0.080 g, 0.087 mmol) were combined in round bottom flask and dissolved in 15 ml of dry toluene. The solution was stirred for a minute and followed by sodium *tert*-butoxide (0.37 g, 3.84 mmol) and 5 ml of dry toluene. A heating mantle was added  
20 and the reaction heated to 60C for 3 days. The reaction mixture was then cooled to room temperature and filtered through a 1 inch plug of silica gel and one inch of celite, washing with toluene (500 mL). Removal of volatiles under reduced pressure gave a yellow solid. The crude product was purified further by silica gel column chromatography using a gradient  
25 of chloroform in hexanes (0 % to 40 %). Recrystallization from DCM and acetonitrile yielded 0.900 g (59%) of product as a yellow solid.  $^1\text{H}$  NMR ( $\text{CDCl}_3$ ) is consistent with structure.

Example 14

This example illustrates the preparation of Compound E16.

In drybox, a round-bottom flask was charged with 6,12-dibromochrysene (220 mg, 1.0 eq), N-(2,4-dimethylphenyl)-3'''-iso-propyl-4,4',4''-  
5 quaterphenylamine (570 mg, 2.02 eq), Pd<sub>2</sub>(dba)<sub>3</sub> (11 mg, 0.02 eq), P(*tert*-Bu)<sub>3</sub> (10 mg, 0.08 eq), sodium *tert*-butoxide (174 mg, 3.0 eq) and *m*-xylene (15 mL). Reaction mixture was heated at 120 °C for 16 hours. Color of the mixture turned from reddish to yellowish. Progress of the amination was monitored by LC and reaction was stopped after all bromide was  
10 consumed. Solution was concentrated *via* rotoevaporation and washed on a frit with water followed by diethyl ether. The remaining solid was dried under high vacuum. Crude product was purified by column chromatography on a CombiFlush silica gel column with CHCl<sub>3</sub>/hexane gradient, 0-40%. The purest product fraction was collected and  
15 concentrated to give 170 mg of product after precipitation with MeOH. LC Purity is 99.99 %. Analysis by <sup>1</sup>H NMR indicated that the product was Compound E16.

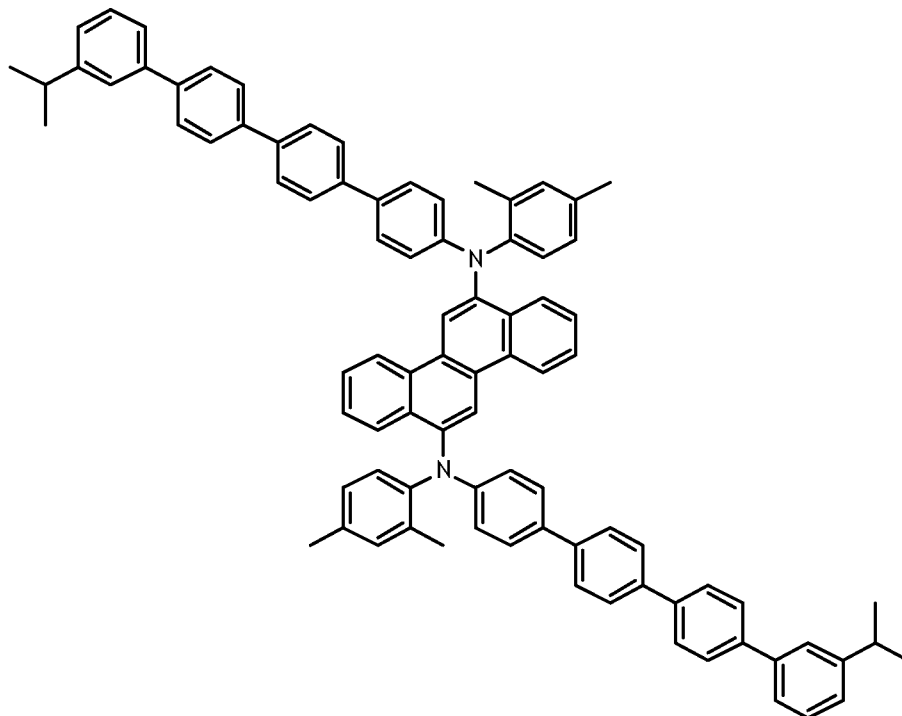

Example 15

This example illustrates the preparation of Compound E17.

In drybox, a round-bottom flask was charged with 6,12-dibromochrysene (215 mg, 1.0 eq), N-(2,4-dimethylphenyl)-4'''-n-nonyl-4,4',4''-

- 5 quaterphenylamine (651 mg, 2.02 eq), Pd<sub>2</sub>(dba)<sub>3</sub> (11 mg, 0.02 eq), P(*tert*-Bu)<sub>3</sub> (9 mg, 0.08 eq), sodium *tert*-butoxide (168 mg, 3.0 eq) and *m*-xylene (10 mL). Reaction mixture was heated at 130 °C for 16 hours. Color of the mixture turned from reddish to greenish. Progress of the amination was monitored by LC and reaction was stopped after all bromide was
- 10 consumed. Solution was concentrated *via* rotoevaporation. Crude product was purified by column chromatography on a Biotage silica gel column with CH<sub>2</sub>Cl<sub>2</sub>/hexane gradient, 5-40%, followed by another column with CHCl<sub>3</sub>/hexane, gradient 5-40%. The purest fractions were further purified by re-precipitation from CH<sub>2</sub>Cl<sub>2</sub> with CH<sub>3</sub>CN at low temperatures.
- 15 The resulting solid was filtered off to give 240 mg of product. Analysis by <sup>1</sup>H NMR indicated that the product was Compound E17.

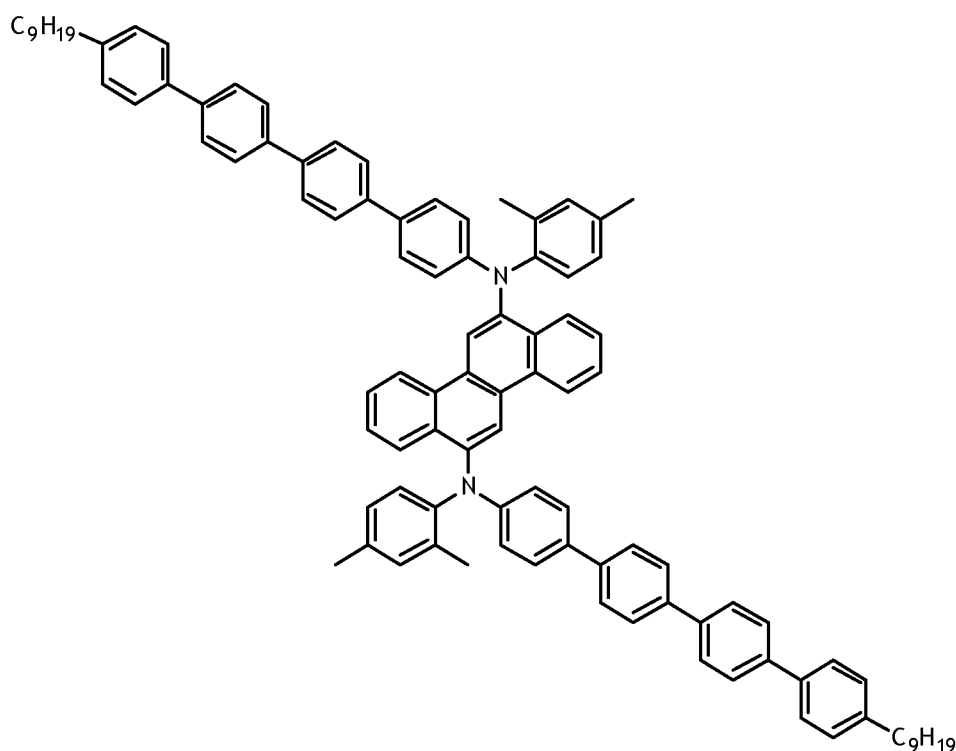

Compounds E3, E10, and comparative compound A

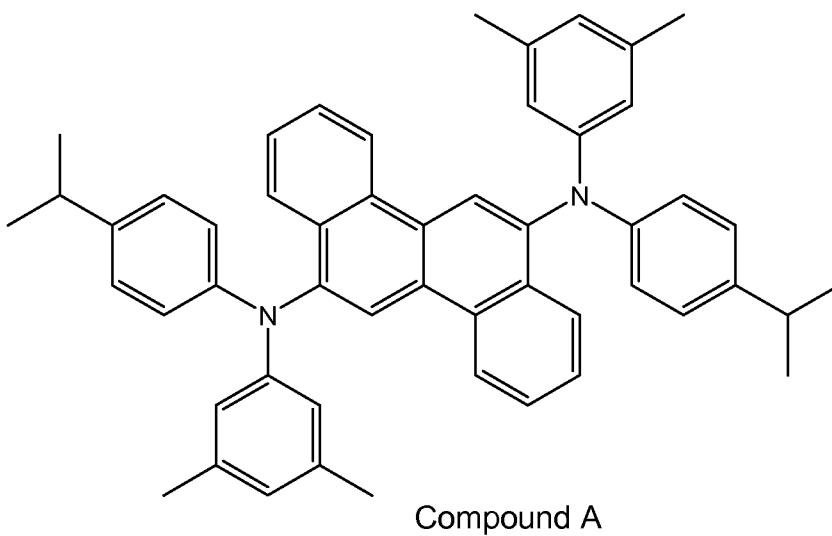

5 were made using synthetic techniques analogous to those described above.

Additional Materials:

10 P1

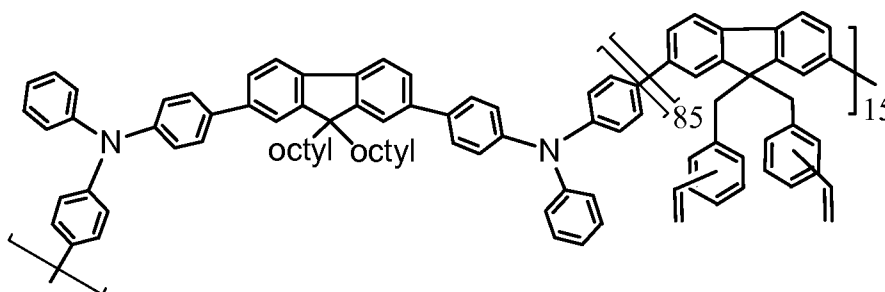

15 P2

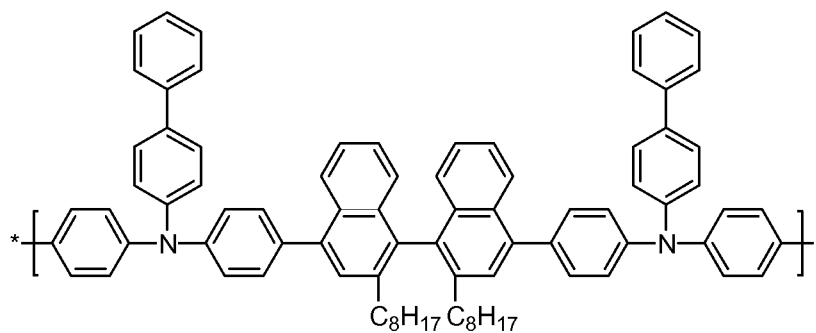

P3

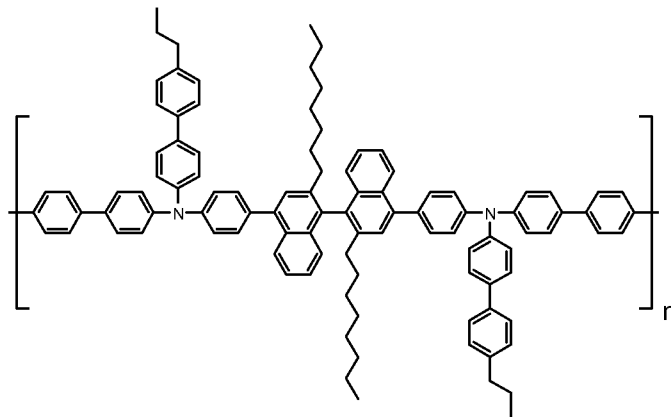

5

H1

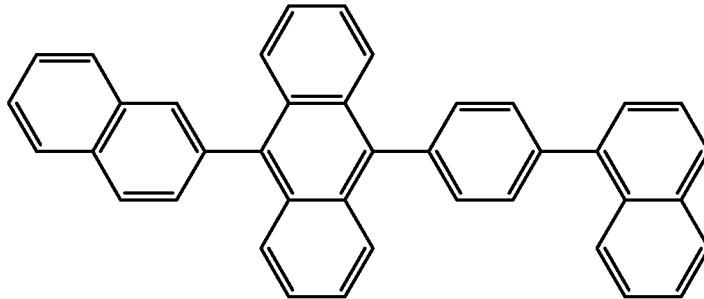

10

H2

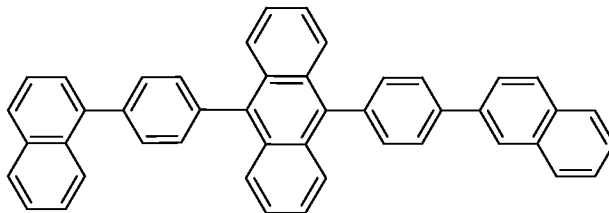

15

Examples 16, 17 and Comparative A

These examples demonstrate the fabrication and performance of a device having a first structure. The following materials were used:

Indium Tin Oxide (ITO): 50 nm

20

buffer layer = Buffer 1 (25 nm), which is an aqueous dispersion of an electrically conductive polymer and a polymeric fluorinated sulfonic acid. Such materials have been described in, for example, published U.S. patent applications US 2004/0102577, US 2004/0127637, and US 2005/0205860.

25

hole transport layer = polymer P1 (20 nm)

photoactive layer = 13:1 host H2:dopant (48 nm)

electron transport layer = a metal quinolate derivative (20 nm)

cathode = LiF/Al (0.5/100 nm)

OLED devices were fabricated by a combination of solution  
5 processing and thermal evaporation techniques. Patterned indium tin  
oxide (ITO) coated glass substrates from Thin Film Devices, Inc were  
used. These ITO substrates are based on Corning 1737 glass coated with  
ITO having a sheet resistance of 30 ohms/square and 80% light  
transmission. The patterned ITO substrates were cleaned ultrasonically in  
10 aqueous detergent solution and rinsed with distilled water. The patterned  
ITO was subsequently cleaned ultrasonically in acetone, rinsed with  
isopropanol, and dried in a stream of nitrogen.

Immediately before device fabrication the cleaned, patterned ITO  
substrates were treated with UV ozone for 10 minutes. Immediately after  
15 cooling, an aqueous dispersion of Buffer 1 was spin-coated over the ITO  
surface and heated to remove solvent. After cooling, the substrates were  
then spin-coated with a solution of a hole transport material, and then  
heated to remove solvent. After cooling the substrates were spin-coated  
with the emissive layer solution, and heated to remove solvent. The  
20 substrates were masked and placed in a vacuum chamber. The electron  
transport layer was deposited by thermal evaporation, followed by a layer  
of LiF. Masks were then changed in vacuo and a layer of Al was  
deposited by thermal evaporation. The chamber was vented, and the  
devices were encapsulated using a glass lid, dessicant, and UV curable  
25 epoxy. The different structures are summarized in Table 1.

The OLED samples were characterized by measuring their  
(1) current-voltage (I-V) curves, (2) electroluminescence radiance versus  
voltage, and (3) electroluminescence spectra versus voltage. All three  
measurements were performed at the same time and controlled by a  
30 computer. The current efficiency of the device at a certain voltage is  
determined by dividing the electroluminescence radiance of the LED by  
the current density needed to run the device. The unit is a cd/A. The  
power efficiency is the current efficiency divided by the operating voltage.  
The unit is lm/W. The device data is given in Table 2.

The following dopants were used:

Example 16: E2

Example 17: E3

Comparative Example A: Compound A

5

Examples 18-20 and Comparative B

These examples show the performance of a device made with a second structure having a different host material and a different cathode material.

10 The devices were made using the procedure of Example 13, except that the host was H1, and the cathode was CsF/Al (0.7/100nm).

The following dopants were used:

Example 18: E5

Example 19: E6

15 Example 20: E7

Comparative Example B: Compound A

Examples 21-24 and Comparative C

20 These examples show the performance of a device made with a third structure having a different hole transport layer.

The devices were made using the procedure of Example 15, except that the hole transport layer was P2.

The following dopants were used:

Example 21: E6

25 Example 22: E7

Example 23: E8

Example 24: E9

Comparative Example C: Compound A

30 Examples 25-26 and Comparative D

These examples show the performance of a device made with a fourth structure having different layer thicknesses and a different hole transport layer.

A device was made using the procedure of Example 18, except that the buffer layer = Buffer 1 had a thickness of 50 nm, the hole transport layer was P3, the photoactive layer had a thickness of 40 nm, and the electron transport layer had a thickness of 10 nm.

5 The dopants used were:

Example 25: E9

Example 26: E10

Comparative Example D: Compound A

10 **TABLE 1. Device Structure**

Structure	Buffer	HTL	PL	ETL	Cathode
First	25 nm	P1 20 nm	host = H2 48 nm	20 nm	LiF/Al 0.5/100 nm
Second	25 nm	P1 20 nm	host = H1 48 nm	20 nm	CsF/Al 0.7/100 nm
Third	25 nm	P2 20 nm	host = H1 48 nm	20 nm	CsF/Al 0.7/100 nm
Fourth	50 nm	P3 20 nm	host = H1 40 nm	10 nm	CsF/Al 0.7/100 nm

Buffer layer = Buffer 1 for all

HTL = hole transport layer

PL = photoactive layer

ETL = electron transport layer, which is the same metal quinolate compound for all

15

**TABLE 2. Device Performance**

Example	Structure	Dopant	CE [cd/A]	Voltage (V)	CIE [x]	CIE [y]	Lum. $\frac{1}{2}$ Life [h]
16	First	E2	4.5	5.2	0.137	0.154	7560
17	First	E3	4.5	5.3	0.134	0.155	9200
Comp. A	First	Cmpd. A	4.9	5.2	0.136	0.143	4800
18	Second	E5	5.4	4.6	0.135	0.162	6250
19	Second	E6	5.3	4.6	0.136	0.148	6550
20	Second	E7	5.3	4.6	0.136	0.154	4770
Comp. B	Second	Cmpd. A	4.9	4.7	0.138	0.134	2700
21	Third	E6	6.2	4.7	0.137	0.141	12450
22	Third	E7	6.4	4.7	0.136	0.147	15640

<b>23</b>	Third	E8	6.0	4.8	0.138	0.136	11680
<b>24</b>	Third	E9	6.3	4.7	0.136	0.145	14100
<b>Comp. C</b>	Third	Cmpd. A	6.1	4.8	0.139	0.134	6600
<b>25</b>	Fourth	E9	6.0	4.4	0.134	0.128	13950
<b>26</b>	Fourth	E10	5.6	4.4	0.134	0.125	12230
<b>Comp. D</b>	Fourth	Cmpd. A	5.9	4.5	0.136	0.115	6000

\* All data @ 1000 nits, CE = current efficiency; CIE<sub>x</sub> and CIE<sub>y</sub> are the x and y color coordinates according to the C.I.E. chromaticity scale (Commission Internationale de L'Eclairage, 1931). Lum. ½ Life is defined as the time in hours for a device to reach one-half the initial luminance.

As can be seen in Fig. 2, the relative lifetime of devices made with the chrysene dopants having Formula I are significantly better than comparative Compound A. The relative lifetime increases dramatically as a and b increase. Relative lifetime is defined as (Lum ½ Life of Example X)/(Lum ½ Life of Comparative Example Y) where Comparative Example Y is the comparative example with the same device structure and materials (other than the dopant). For example, the relative lifetime for Example 13 would be (Lum ½ Life of Example 13)/(Lum ½ Life of Comparative Example A) = 7560 h/4800 h = 1.58. The relative lifetime for Example 23 would be (Lum. ½ Life of Example 23) divided by (Lum. ½ Life of Comparative Example D) = 12230 h/6000 h = 2.04. It is unexpected that increasing the number of linearly attached phenyl groups on the nitrogen going from biphenyl, to terphenyl, to quaterphenyl and above, should have this effect.

Note that not all of the activities described above in the general description or the examples are required, that a portion of a specific activity may not be required, and that one or more further activities may be performed in addition to those described. Still further, the order in which activities are listed are not necessarily the order in which they are performed.

In the foregoing specification, the concepts have been described with reference to specific embodiments. However, one of ordinary skill in

the art appreciates that various modifications and changes can be made without departing from the scope of the invention as set forth in the claims below. Accordingly, the specification and figures are to be regarded in an illustrative rather than a restrictive sense, and all such modifications are intended to be included within the scope of invention.

Benefits, other advantages, and solutions to problems have been described above with regard to specific embodiments. However, the benefits, advantages, solutions to problems, and any feature(s) that may cause any benefit, advantage, or solution to occur or become more pronounced are not to be construed as a critical, required, or essential feature of any or all the claims.

It is to be appreciated that certain features are, for clarity, described herein in the context of separate embodiments, may also be provided in combination in a single embodiment. Conversely, various features that are, for brevity, described in the context of a single embodiment, may also be provided separately or in any subcombination. Further, reference to values stated in ranges include each and every value within that range.

CLAIMS

What is claimed is:

1. A compound having Formula I:

5

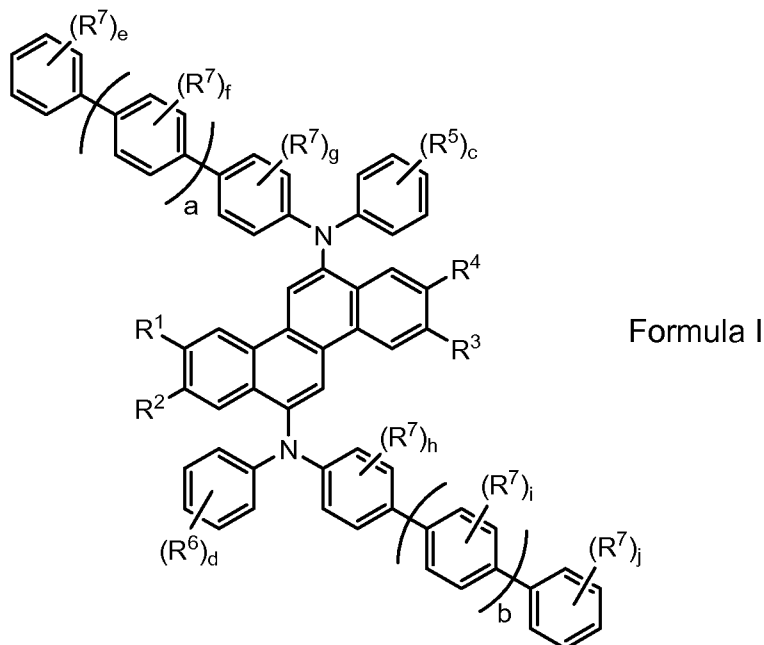

wherein:

10  $R^1$ ,  $R^2$ ,  $R^3$  and  $R^4$  are the same or different and are selected from the group consisting of H and alkyl, where  $R^1$  and  $R^2$  groups or  $R^3$  and  $R^4$  groups may be joined together to form a 5- or 6-membered aliphatic ring;

15  $R^5$  and  $R^6$  are the same or different and are selected from the group consisting of alkyl groups, m-phenyl, o-phenyl, p-phenyl, m-carbazolyl, and p-carbazolyl;

$R^7$  is the same or different at each occurrence and is selected from the group consisting of alkyl groups, phenyl, and biphenyl, or two adjacent  $R^7$  groups can join together to form a naphthyl group;

20 a and b are the same or different and are an integer from 0-10;  
c and d are the same or different and are an integer from 1-3;

f, g, h, and i, are the same or different at each occurrence and are an integer from 0-4; and

e and j are the same or different at each occurrence and are an integer from 0-5.

5           2.       The compound of Claim 1, wherein R<sup>1</sup> is a branched hydrocarbon alkyl group selected from the group consisting of isopropyl, 2-butyl, t-butyl and 2-(2-methyl)-butyl, and R<sup>2</sup> through R<sup>4</sup> are H.

10           3.       The compound of Claim 1, wherein R<sup>1</sup> and R<sup>2</sup> taken together form an aliphatic ring selected from the group consisting of cyclopentyl and cyclohexyl and R<sup>3</sup> and R<sup>4</sup> are H.

            4.       The compound of Claim 1, wherein each of R<sup>1</sup> through R<sup>4</sup> is H.

15

            5.       The compound of Claim 1, wherein R<sup>5</sup> and R<sup>6</sup> are hydrocarbon alkyl groups having 1-6 carbon atoms.

            6.       The compound of Claim 1, wherein c = d = 1 or 2.

20

            7.       The compound of Claim 1, wherein R<sup>5</sup> and R<sup>6</sup> are aromatic groups selected from the group consisting of o-phenyl, m-phenyl, and m-carbazolyl groups.

25           8.       The compound of Claim 1, wherein R<sup>7</sup> is a hydrocarbon alkyl group having 1-10 carbon atoms.

            9.       The compound of Claim 8, wherein at least one of a through j is greater than 0.

30

            10.      The compound of Claim 1, wherein e = f = g = h = i = j = 0.

            11.      The compound of Claim 1, wherein a = b = 1-10.

12. The compound of Claim 1, wherein  $a = b = 2-5$ .

13. A compound selected from E1 through E17.

5

14. An organic electronic device comprising a first electrical contact layer, a second electrical contact layer, and at least one active layer therebetween, wherein the active layer comprises a compound having Formula I:

10

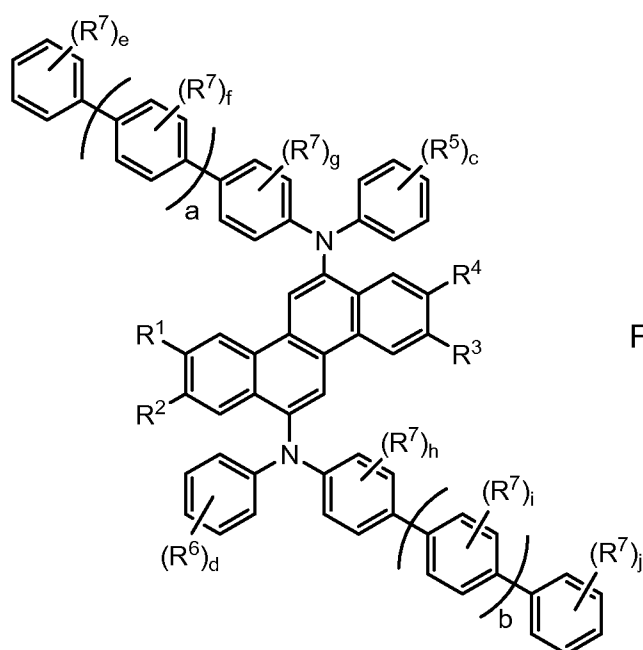

Formula I

wherein:

15  $R^1$ ,  $R^2$ ,  $R^3$  and  $R^4$  are the same or different and are selected from the group consisting of H and alkyl, where  $R^1$  and  $R^2$  groups or  $R^3$  and  $R^4$  groups may be joined together to form a 5- or 6-membered aliphatic ring;

20  $R^5$  and  $R^6$  are the same or different and are selected from the group consisting of alkyl groups, m-phenyl, o-phenyl, p-phenyl, m-carbazolyl, and p-carbazolyl;

$R^7$  is the same or different at each occurrence and is selected from the group consisting of alkyl groups, phenyl, and biphenyl, or two adjacent  $R^7$  groups can join together to form a naphthyl group;

5 a and b are the same or different and are an integer from 0-10;  
c and d are the same or different and are an integer from 1-3;  
f, g, h, and i, are the same or different at each occurrence and are  
an integer from 0-4; and  
10 e and j are the same or different at each occurrence and are an  
integer from 0-5.

15 15. The device of Claim 14, wherein  $R^1$  is a branched hydrocarbon alkyl group selected from the group consisting of isopropyl, 2-butyl, t-butyl and 2-(2-methyl)-butyl, and  $R^2$  through  $R^4$  are H.

16 16. The device of Claim 14, wherein  $R^1$  and  $R^2$  taken together form an aliphatic ring selected from the group consisting of cyclopentyl and cyclohexyl.

20 17. The device of Claim 14, wherein  $R^1$  through  $R^4$  is H.

18. The device of Claim 14, wherein  $R^5$  and  $R^6$  are hydrocarbon alkyl groups having 1-6 carbon atoms.

25 19. The device of Claim 14, wherein  $R^5$  and  $R^6$  are aromatic groups selected from the group consisting of o-phenyl, m-phenyl, and m-carbazolyl groups.

30 20. The device of Claim 14, wherein  $R^7$  is a hydrocarbon alkyl group having 1-10 carbon atoms.

21. The device of Claim 14, wherein at least one of a through j is greater than 0.

22. The device of Claim 14, wherein  $a = b = 1-10$ .

23. The device of Claim 14, wherein  $a = b = 2-5$ .

5

24. The device of Claim 14, wherein the compound of Formula I is selected from E1 through E17.

25. The device of Claim 14, wherein the active layer is a  
10 photoactive layer and further comprises a host material.

26. The device of Claim 25, further comprising a buffer layer between the first electrical contact layer and the active layer.

15 27. The device of Claim 26, wherein the buffer layer comprises at least one electrically conductive polymer and at least one fluorinated acid polymer.

FIGURE 1

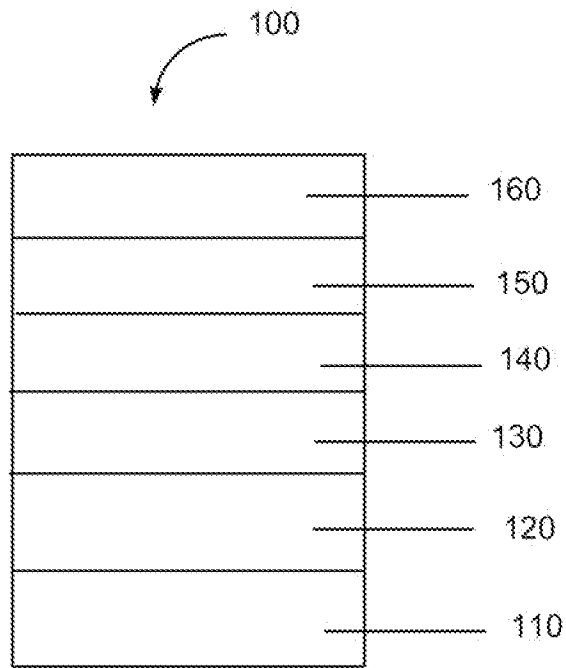
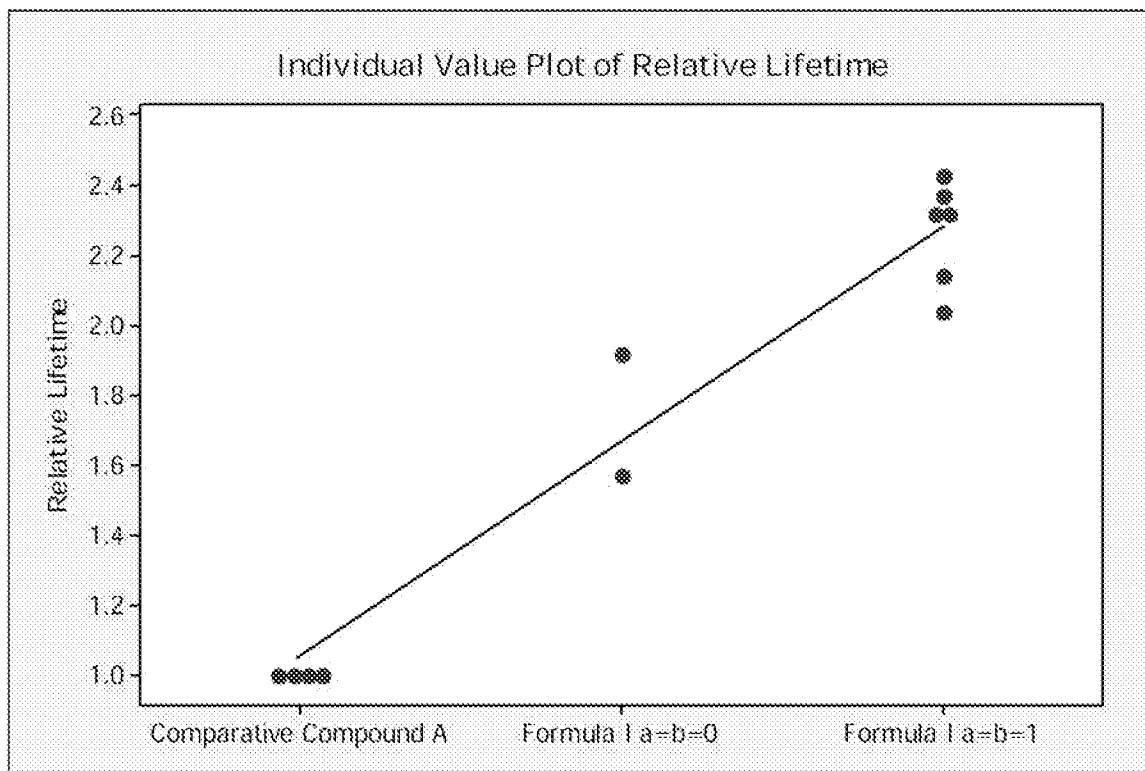

FIGURE 2



专利名称(译)	用于蓝色或绿色发光应用的Chrysene化合物		
公开(公告)号	<a href="#">EP2350230A4</a>	公开(公告)日	2012-08-22
申请号	EP2009828227	申请日	2009-11-19
[标]申请(专利权)人(译)	纳幕尔杜邦公司		
申请(专利权)人(译)	E·I·杜邦和公司		
当前申请(专利权)人(译)	E·I·杜邦和公司		
[标]发明人	WU WEISHI HERRON NORMAN ROSTOVTSEV VSEVOLOD MERLO JEFFREY A GAO WEIYING		
发明人	WU, WEISHI HERRON, NORMAN ROSTOVTSEV, VSEVOLOD MERLO, JEFFREY, A. GAO, WEIYING		
IPC分类号	C09K11/06 H05B33/00		
CPC分类号	C09K11/06 C09B57/00 C09B57/001 C09B57/008 C09K2211/1014 H01L51/0054 H01L51/006 H01L51/0075 H05B33/14		
代理机构(译)	霍夫曼BENJAMIN		
优先权	61/115984 2008-11-19 US		
其他公开文献	EP2350230A2		
外部链接	<a href="#">Espacenet</a>		

#### 摘要(译)

本发明涉及可用于电致发光应用并且能够发蓝光或绿光的chrysene化合物。它还涉及其中活性层包含这种化合物的电子器件。