



(12) **EUROPEAN PATENT APPLICATION**
published in accordance with Art. 158(3) EPC

(43) Date of publication:
15.11.2006 Bulletin 2006/46

(51) Int Cl.:
H05B 33/24 (2006.01) **H05B 33/12** (2006.01)
H05B 33/14 (2006.01) **H05B 33/26** (2006.01)

(21) Application number: **05720006.5**

(86) International application number:
PCT/JP2005/003734

(22) Date of filing: **04.03.2005**

(87) International publication number:
WO 2005/086541 (15.09.2005 Gazette 2005/37)

(84) Designated Contracting States:
**AT BE BG CH CY CZ DE DK EE ES FI FR GB GR
HU IE IS IT LI LT LU MC NL PL PT RO SE SI SK TR**

- **YUASA, Kimihiro**
2990293 (JP)
- **HOSOKAWA, Chishio**
2990293 (JP)

(30) Priority: **05.03.2004 JP 2004062773**

(71) Applicant: **IDEMITSU KOSAN CO., LTD.**
Tokyo 100-8321 (JP)

(74) Representative: **Gille Hrabal Struck Neidlein Prop
Roos**
Brucknerstrasse 20
40593 Düsseldorf (DE)

(72) Inventors:
• **FUKUOKA, Kenichi**
2990293 (JP)

(54) **ORGANIC ELECTROLUMINESCENCE ELEMENT AND DISPLAY**

(57) An organic electroluminescent device including at least a first light reflecting layer (2), a first transparent electrode (3), an organic emitting layer (4), a second transparent electrode (5) and a second light reflecting layer (6) stacked on a substrate (1) in this order; wherein at least one of the first light reflecting layer (2) and the second light reflecting layer (6) is light semi-transmissive. Applied light (A) is reflected between the first and second

light reflecting layers (2), (6) and undergoes optical interference effect, and reflected light (B) is emitted outside through the second light reflecting layer (6) which is semi-transmissive. At that time, by adjusting an optical path length between the light reflecting layers (2) and (6), the spectrum of reflected light (B) is allowed to have a sharp peak with a specific value. As a result, the color purity is improved.

FIG. 1

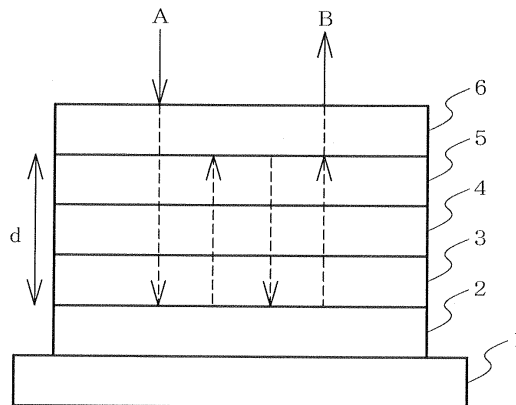

Description

Technical Field

5 **[0001]** The invention relates to an organic electroluminescent (EL) device. In particular, the invention relates to a white organic EL device.

Background Art

10 **[0002]** An organic EL device has been expected as a next-generation flat display due to self-emitting properties and the like. As a full-color display method, a three-color pattern formation method, a color changing medium (CCM) method, and a white color filter (CF) method have been proposed. A method suitable for a large-screen display has not been necessarily determined.

15 **[0003]** The three-color pattern formation method, which is relatively widely used at present and utilizes a high-definition deposition mask, has a problem in forming a large-screen display. On the other hand, since the white CF method does not require a high-definition deposition mask and allows utilization of a CF used for an LCD, the white CF method is expected as a method of forming a large-screen organic EL display.

20 **[0004]** However, a conventional white CF method has a problem relating to the color reproducibility of the display. This is because it is generally difficult to obtain an organic EL emission spectrum with a small half-width. The organic EL obtains white light by mixing the colors of light from organic materials which emit light of different colors. When causing such white light to pass through a color filter, the color purity of the light deteriorates after passing through the color filter due to a large half-width. The color purity can be improved by adjusting the color filter. However, the amount of light passing through the color filter decreases, whereby power consumption increases.

25 **[0005]** An attempt has been made to utilize optical interference for an organic EL device. For example, when using an organic EL device in which a first electrode formed of a light reflecting material, an organic layer including an organic emitting layer, a semitransparent reflecting layer, and a second electrode formed of a transparent material are stacked such that the organic layer serves as a resonator, the optical length L is adjusted to be minimized within the range in which $2L/\lambda + \varphi/(2\pi) = m$ is satisfied wherein m is an integer, φ is a phase shift, and λ is the peak wavelength of the spectrum of light to be outcoupled (see patent document 1). In a structure in which an organic EL layer is placed between
30 a light reflecting layer and a transparent layer, each of R, G, and B pixels has a color filter disposed on the light-outcoupling side or the external light incident side of the transparent layer (see patent document 2).

35 **[0006]** However, the above devices have the following problems. (1) Since the actual thickness which satisfies the above expression must be considerably reduced in comparison with a general organic EL device, a conduction failure tends to occur, or the actual thickness may differ from the thickness optimum for the organic emitting material from the viewpoint of luminous efficiency. (2) In order to form a full-color device, it is necessary to form the device to have a thickness corresponding to each color in pixel units, thereby making production difficult. (3) The light selectivity may be insufficient since conditions where the order m is small are utilized.

[0007]

40 Patent document 1: W02001/039554
Patent document 2: JP-A-H14-373776

[0008] An object of the invention is to provide an organic EL device and display which excel in color purity.

45 Disclosure of the Invention

[0009] The inventors found that an organic EL device having a specific device structure of interposing between two light reflecting layers is allowed to have three or more wavelength characteristics in the visible region when the optical path length formed by the two reflective surfaces is set to be a specific value. The invention was accomplished by this
50 finding.

The invention provides the following organic EL device and display.

1. An organic electroluminescent device comprising at least: a first light reflecting layer, a first transparent electrode, an organic emitting layer, a second transparent electrode and a second light reflecting layer stacked on a substrate
55 in this order; at least one of the first light reflecting layer and the second light reflecting layer being light semi-transmissive.
2. The organic electroluminescent device according to 1, wherein the emission from the organic electroluminescent device has at least 3 peaks in the wavelengths of 400 to 800 nm.

3. The organic electroluminescent device according to 1 or 2, wherein a light transmitting protective layer is placed between the second transparent electrode and the second light reflecting layer.

4. The organic electroluminescent device according to any one of 1 to 3, wherein an average thickness of all layers interposed between the first light reflecting layer and the second light reflecting layer is 100 to 1000 nm.

5. The organic electroluminescent device according to any one of 1 to 4, wherein at least one of the first transparent electrode and the second transparent electrode is formed of an oxide of one kind or two or more kinds of elements selected from the group consisting of In, Sn, Zn, and Cd.

6. The organic electroluminescent device according to any one of 1 to 5, wherein at least one of the first light reflecting layer and the second light reflecting layer is provided with a light diffusion part.

7. A display comprising the organic electroluminescent device according to any one of 1 to 6 and a color conversion member.

8. A display comprising the organic electroluminescent device according to any one of 1 to 6 and a color filter.

[0010] In the organic EL device of the invention, light emitted from the organic emitting layer is reflected in an optical interference part and undergoes optical interference effect. At this time, the spectrum of output light can be caused to have a peak of specific wavelength by adjusting the optical path length of the optical interference part. Further, the peak of specific wavelength can be made sharper. As a result, color purity is improved. The color purity is further enhanced by using a color conversion member or color filter. For example, when it is desired to output light of three colors using a color filter, light more excel in color purity can be obtained because three colors have been strengthened in the spectrum of a device in advance.

[0011] Accordingly, the invention can provide an organic EL device and display excel in color purity. The organic EL device can be easily fabricated since the entire devices have the same configuration and thickness.

Brief Description of Drawings

[0012]

Fig. 1 is a view showing an organic EL device according to First embodiment.

Fig. 2 is a graph showing the spectrum of reflected light from the organic EL device according to First embodiment.

Fig. 3(a) is a graph showing the white emission spectrum of an organic emitting layer.

Fig. 3(b) is a graph showing light reflection characteristic when an organic EL device is not driven.

Fig. 3(c) is a graph showing the spectrum of EL light emitted to the outside from a device.

Fig. 4a is a view showing one example of the organic EL device configuration.

Fig. 4b is a view showing another example of the organic EL device configuration.

Fig. 4c is a view showing another example of the organic EL device configuration.

Fig. 4d is a view showing another example of the organic EL device configuration.

Fig. 4e is a view showing another example of the organic EL device configuration.

Fig. 4f is a view showing another example of the organic EL device configuration.

Fig. 4g is a view showing another example of the organic EL device configuration.

Fig 5 is a view showing an organic EL device according to Second embodiment.

Fig. 6 is a graph showing the spectrum of reflected light from the organic EL device according to Second embodiment.

Fig. 7a is a view showing an organic EL device fabricated in Example 1.

Fig. 7b is a view showing an organic EL device fabricated in Comparative example 1.

Fig. 7c is a view showing an organic EL device fabricated in Example 2.

Fig. 7d is a view showing an organic EL device fabricated in Comparative example 2.

Best mode for Carrying out the Invention

First embodiment

[0013] FIG. 1 is a view showing an organic EL device according to one embodiment of the invention, and FIG. 2 is a graph showing the spectrum of reflected light from the organic EL device.

The organic EL device includes a substrate 1, a first light reflecting layer 2, a first transparent electrode 3, an organic emitting layer 4, a second transparent electrode 5 and a second light reflecting layer 6 stacked in that order. In this embodiment, the second light reflecting layer 6 is light semi-transmissive. When light with a wavelength of 400 to 800 nm enters the unenergized device through the second light reflecting layer 6, as indicated by the arrow A, the light is reflected by the first light reflecting layer 2 and emitted through the second light reflecting layer 6, as indicated by the arrow B. In this case, the light is repeatedly reflected between the first and second light reflecting layers 2 and 6 indicated

by (d) and undergoes optical interference effects, whereby the spectrum of the reflected light preferably has at least three minimum values in the wavelength region of 400 to 800 nm, as shown in FIG. 2. The spectrum of the reflected light preferably has at least three peaks with a half-width of 150 nm or less.

[0014] In the organic EL device, light emitted from an organic emitting layer is repeatedly reflected between two light reflecting surfaces (indicated by d in FIG. 1), and light with a wavelength λ satisfying the following expression is enhanced and emitted to the outside of the device.

$$2L/(\lambda + \phi/2\pi) = m \quad (m \text{ is an integer of } 0 \text{ or more})$$

$$L = \sum nd$$

(L indicates the optical length, d indicates the film thickness, n indicates the refractive index of the member provided between two light reflecting surfaces, and λ indicates the wavelength of light)

[0015] Therefore, the spectrum of light from the device appears as a result of synergistic effects of the emission spectrum specific to the EL material and the transmission characteristics due to the interference effects. It is possible to provide selectivity for three or more wavelengths in the visible region by providing a specific optical path length L.

[0016] The effects of interference between two light reflecting surfaces may be confirmed without applying current to the organic EL device. Specifically, light is caused to enter the display surface of the device from the outside, and the wavelength dependence of the light reflection of the device is measured. It has characteristics almost reverse to the light transmission characteristics of the device for internal EL emission. Therefore, when a minimal peak of a reflection index exists, it can be determined that the EL light is selectively transmitted at that wavelength.

[0017] The reflection spectrum may be measured by applying monochromatic light while sequentially changing the wavelength in the region of 400 to 800 nm, and measuring the reflection intensity at those wavelengths, for example.

[0018] In this embodiment, two or more minimal peaks of a reflection index can be obtained by adjusting the thickness (optical path length) of the layers 3, 4 and 5 provided between the first and second light reflecting layers 2 and 6. The thickness between the first and second light reflecting layers 2 and 6 is preferably 100 to 1000 nm.

[0019] It is preferable to stack a color conversion member or a color filter on the light-outcoupling side of the device in order to allow the device to emit light of a plurality of colors (multicolor device). As the color conversion member, a fluorescent member which converts part of the received light into light with a different wavelength may be used. The color conversion member and the color filter may be used in combination.

[0020] As the color filter, a generally-used color filter may be used. Since this device can be provided in advance with the emission spectrum matching the transmission characteristics of a color filter, light of an extremely pure color can be emitted in comparison with the case of stacking a color filter on a general device.

[0021] A light diffusion part may be stacked on the first and/or second light reflecting layers 2 and 6 in order to improve the viewing angle characteristics. As the light diffusion part, any means used for a liquid crystal display, an organic EL display, and the like may be used, such as a transparent plate provided with a number of minute grooves or holes in its surface, a transparent plate in which minute bubbles or particles are dispersed, or a transparent plate in which a microprism is formed on its surface.

[0022] When forming a multicolor device using the color conversion member or the color filter, it is effective to dispose the light diffusion part outside the color conversion member or the color filter in the opposite direction to the device. Note that the color conversion member or the color filter layer may be processed as described above to integrate the light diffusion part into the color conversion member or the color filter layer.

[0023] When the emission spectrum of the organic emitting layer is white, a full-color device may be realized using a simple configuration by adjusting the optical path length so that the emission spectrum has three maximum values corresponding to red, green, and blue. FIG. 3(a) shows the white emission spectrum of the organic emitting layer, and FIG. 3(b) shows the light transmission characteristics of the device, in which the reflection spectrum measured without operating the device is illustrated. FIG. 3(b) indicates that minimal values of reflective index exist at 470 nm, 550 nm, and 620 nm, and light emitted from the device is selectively transmitted at these wavelengths. As a result, when applying current to the device, the spectrum of light emitted to the outside of the device from the reflection side has the maximum values of the three primary colors, as shown in FIG. 3(c). A device exhibiting particularly excellent color reproducibility is obtained by combining the device with a color filter. As described above, the maximum values of the three primary colors are obtained by merely adjusting the optical path length. As a result, light with extremely high color purity can be efficiently outcoupled.

[0024] In this embodiment, the optical path length is adjusted by changing the thickness between the first and second light reflecting layers 2 and 6, that is, the type and thickness of the layers therebetween. These layers include at least an organic emitting layer. The thickness between the first and second light reflecting layers may be adjusted by stacking

an organic compound layer and/or an inorganic compound layer other than the organic emitting layer.

[0025] As shown in FIGS. 4a to 4k, the following device configurations may be given as examples. Optical interference occurs between a first light reflecting layer 41 and a second light reflecting layer 42 provided on a substrate 40.

[0026]

5

FIG. 4a; substrate 40 / first light reflecting layer 41 / first transparent electrode 45a / organic layer 43 / second transparent electrode 45b / light transmitting protective layer 44 / second light reflecting layer 42

FIG. 4b; substrate 40 / first light reflecting layer 41 / first transparent electrode 45a / hole transporting layer 46 / organic layer 43 / second transparent electrode 45b / second light reflecting layer 42

10 FIG. 4c; substrate 40 / first light reflecting layer 41 / first transparent electrode 45a / organic layer 43 / electron transporting layer 47 / second transparent electrode 45b / second light reflecting layer 42

FIG. 4d; substrate 40 / first light reflecting layer 41 / first transparent electrode 45a / hole transporting layer 46 / organic layer 43 / electron transporting layer 47 / second transparent electrode 45b / second light reflecting layer 42

15 FIG. 4e; substrate 40 / first light reflecting layer 41 / first transparent electrode 45a / hole injecting layer 48 / hole transporting layer 46 / organic layer 43 / electron transporting layer 47 / second transparent electrode 45b / second light reflecting layer 42

FIG. 4f; substrate 40 / first light reflecting layer 41 / first transparent electrode 45a / organic layer 43 / second transparent electrode 45b / sealing layer 49 / second light reflecting layer 42

20 FIG. 4g; substrate 40 / first light reflecting layer 41 / first transparent electrode 45a / organic layer 43a / second transparent electrode 45b / organic layer 43b / third transparent electrode 45c / second light reflecting layer 42

[0027] In FIG. 4a, a transparent electrode which generally has small film thickness and is poor in mechanical strength can be reinforced by providing the light transmitting protective layer 44.

25 In FIGS. 4a to 4g, the electrode includes not only a low-resistivity metal, but also a semiconductor substance. The transparent electrode is not particularly limited. When disposing the transparent electrode between two light reflecting layers, the transparent electrode preferably has a refractive index close to that of the organic layer.

[0028] The organic layer is not particularly limited insofar as the organic layer includes the organic emitting layer. The organic layer may be either a fluorescence type or a phosphorescence type exhibiting a higher luminous efficiency. It is a common practice to stack or mix a plurality of organic materials in order to obtain an organic EL device exhibiting a higher performance. For example, the following configurations may be employed. Note that the configuration of the organic layer is not limited thereto.

30

Organic emitting layer

Hole transporting layer / organic emitting layer

Organic emitting layer / electron transporting layer

35 Hole transporting layer / organic emitting layer / electron transporting layer

Hole injecting layer / hole transporting layer / organic emitting layer / electron transporting layer

Hole injecting layer / hole transporting layer / organic emitting layer / electron transporting layer / electron injecting layer

Each layer may be a single layer or may include a plurality of layers.

[0029] FIGS. 4a to 4g illustrate the top-emission type device configurations. A bottom-emission type device configuration may also be formed by disposing a transparent substrate on the light translucent layer.

40

Second embodiment

[0030] FIG. 5 is a view showing an organic EL device according to another embodiment of the invention.

45 The organic EL device differ from the device according to the first embodiment in that the first light reflecting layer 2 as well as the second light reflecting layer 6 are made to be light semi-transmissive. As a result, when light with a wavelength of 400 to 800 nm enters the unenergized device through the second light reflecting layer 6, as indicated by the arrow A, the light passes through the first light reflecting layer 2 and is emitted to the outside of the device, as indicated by the arrow C. In this case, the light is repeatedly reflected between the first and second light reflecting layers 2 and 6 and undergoes optical interference effects, whereby the spectrum of the transmitted light has at least three maximum values in the wavelength region of 400 to 800 nm. The spectrum of the transmitted light preferably has at least three peaks with a half-width of 150 nm or less. In this case, the spectrum of the transmitted light has characteristics almost reverse to the characteristics when measuring the reflected light from the second light reflecting layer 6. Specifically, the spectrum of the reflected light has at least three minimum values in the wavelength region of 400 to 800 nm, as shown in FIG. 6.

50
55 **[0031]** In this embodiment, three or more maximum peaks may be obtained for the transmitted light by adjusting the thickness (optical path length) of the layers 3, 4 and 5 provided between the first and second light reflecting layers 2 and 6 like the first embodiment. The thickness between the first and second light reflecting layers 2 and 6 is preferably 100 to 1000 nm. The maximum peak characteristics allow light with these wavelengths to be selectively emitted when

applying current to the device, whereby the color purity is improved.

The configurations of the color conversion member, white emission, and light interference part and the like are the same as in the first embodiment.

[0032] Each member is described below. Note that the configuration of each member is not limited to the following description. Specifically, a known material may be selectively used for each member in addition to the material given in the following description.

(1) Light reflecting layer

[0033] At least one of the two light reflecting layers transmits part of the light (light semi-transmissive) is used in order to outcouple light for use. As the material for these layers, an inorganic compound exhibiting transparency and having a refractive index higher than that of a metal or the organic layer may be utilized. When using a metal, specular reflection occurs due to the metal surface. When using an inorganic compound having a refractive index higher than that of the organic layer, reflection of light occurs corresponding to the magnitude of the difference in refractive index. When forming at least one of the layers as a light semi-transmitting layer, the thickness of the layer is reduced or the difference in refractive index is adjusted. Specific examples are given below.

(a) Light reflecting metal layer

[0034] The light reflecting metal layer is not particularly limited insofar as the light reflecting metal layer can efficiently reflect visible light. The light reflecting metal layer may have a function of injecting electrons or holes into the organic layer. Note that the light reflecting metal layer need not necessarily have this function. Electrons or holes may be injected into the organic layer using a hole injecting layer or an electron injecting layer. As examples of such a material, a material selected from Al, Ag, Au, Pt, Cu, Mg, Cr, Mo, W, Ta, Nb, Li, Mn, Ca, Yb, Ti, Ir, Be, Hf, Eu, Sr, and Ba, and an alloy of these elements can be given.

(b) Light semi-transmitting metal layer

[0035] A metal generally exhibits a low visible light transmittance. On the other hand, a certain substance can transmit visible light by reducing the film thickness. As examples of such a material, the above metals and alloys can be given.

(c) Inorganic compound

[0036] The inorganic compound is not particularly limited insofar as the inorganic compound has a refractive index higher than that of the organic layer. As examples of the inorganic compound, metal oxides of In, Sn, Zn, Cd, Ti, and the like, high-refractive-index ceramic materials, inorganic semiconductor materials, and the like can be given. A resin in which ultrafine particles such as titania are dispersed may also be used.

(2) Transparent electrode

[0037] The transparent electrode is used to increase the optical path length apply the drive voltage to the organic emitting layer, and/or protect the adjacent light reflecting layer mechanically or during the production process. The thickness of the transparent electrode is appropriately adjusted depending on the objective. As the material for the transparent electrode, a light-transmitting material, as used for the anode or the cathode, is used. One kind or two or more kinds of oxides of elements selected from the group consisting of In, Sn, Zn and Cd are preferable.

When the transparent electrode is used to apply the drive voltage to the organic emitting layer, the transparent electrode functions as the anode or the cathode or part of the anode or the cathode. The transparent electrode need not necessarily function as the anode or the cathode. The light reflecting layer may function as the anode or the cathode or part of the anode or the cathode. A member other than the transparent electrode and the light reflecting layer may be provided as the anode or the cathode or part of the anode or the cathode.

(3) Anode

[0038] It is preferable that the anode has a work function of 4.5 eV or more. As examples of the anode, indium tin oxide (ITO), indium zinc oxide (IZO), tin oxide (NESA), gold, silver, platinum, copper and the like can be given. Of these, indium zinc oxide (IZO) is particularly preferable, since IZO film can be formed at room temperature and is highly amorphous so that separation of the anode hardly occurs.

[0039] The sheet resistance of the anode is preferably $1000 \Omega/\square$ or less, more preferably $800 \Omega/\square$ or less, even more

preferably 500 Ω/\square or less.

When luminescence is outcoupled from the anode, the transmittance of the anode to the luminescence is preferably 10% or more, more preferably 30% or more, even more preferably 50% or more.

[0040] Although the optimal value of the film thickness of the anode varies dependent on the material thereof, the thickness is selected generally from 10 nm to 1 μm , preferably 10 nm to 500 nm.

(4) Cathode

[0041] For the cathode, the following may be preferred: an electrode substance made of a metal, an alloy or an electroconductive compound, or a mixture thereof which has a small work function (4 eV or less). Specific examples of the electrode substance include sodium, sodium-potassium alloy, magnesium, lithium, magnesium/silver alloy, aluminum/aluminum oxide, aluminum/lithium alloy, indium, and rare earth metals.

The cathode can be formed by making the electrode substance(s) into a thin film by vapor deposition, sputtering or some other method.

[0042] In the case where luminescence from the organic emitting layer is outcoupled through the cathode, the transmittance of the cathode to the luminescence is preferably 10% or more.

The sheet resistance of the cathode is preferably several hundreds Ω/\square or less. The film thickness of the cathode is generally 10 nm to 1 μm , preferably from 50 to 200 nm.

(5) Light transmitting protective layer

[0043] A light transmitting protective layer is used for reinforcing the adjacent transparent electrode. The material of the light transmitting protective layer is not limited insofar as it is transparent. Transparent conductive materials may be used.

(6) Organic emitting layer

[0044] As methods of forming the organic emitting layer, known methods such as vacuum deposition, spin coating and LB technique can be applied. As disclosed in JP-A-57-51781, the organic emitting layer can also be formed by dissolving a binder such as resins and material compound in a solvent to make a solution and forming a thin film therefrom by spin coating and so on.

[0045] The materials used in the organic emitting layer may be a material known as a luminescent material having a long lifetime. Fluorescent or phosphorescent materials may be used. Phosphorescent materials are preferred due to their excellent luminous efficiency.

As an example, fluorescent materials will be described below. It is preferred to use, as the material of the luminescent material, a material represented by a formula (1).

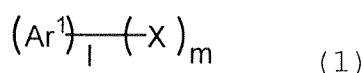

wherein Ar^1 is an aromatic ring with 6 to 50 nucleus carbon atoms, X is a substituent, 1 is an integer of 1 to 5, and m is an integer of 0 to 6.

[0046] Specific examples of Ar^1 include phenyl, naphthyl, anthracene, biphenylene, azulene, acenaphthylene, fluorene, phenanthrene, fluoranthene, acephenanthrylene, triphenylene, pyrene, chrysene, naphthacene, picene, perylene, pentaphene, pentacene, tetraphenylene, hexaphene, hexacene, rubicene, coronene, and trinaphthylene rings.

[0047] Preferred examples thereof include phenyl, naphthyl, anthracene, acenaphthylene, fluorene, phenanthrene, fluoranthene, triphenylene, pyrene, chrysene, perylene, and trinaphthylene rings.

[0048] More preferred examples thereof include phenyl, naphthyl, anthracene, fluorene, phenanthrene, fluoranthene, pyrene, chrysene, and perylene rings.

[0049] Specific examples of X include substituted or unsubstituted aromatic groups with 6 to 50 nucleus carbon atoms, substituted or unsubstituted aromatic heterocyclic groups with 5 to 50 nucleus carbon atoms, substituted or unsubstituted alkyl groups with 1 to 50 carbon atoms, substituted or unsubstituted alkoxy groups with 1 to 50 carbon atoms, substituted or unsubstituted aralkyl groups with 1 to 50 carbon atoms, substituted or unsubstituted aryloxy groups with 5 to 50 nucleus atoms, substituted or unsubstituted arylthio groups with 5 to 50 nucleus atoms, substituted or unsubstituted carboxyl groups with 1 to 50 carbon atoms, substituted or unsubstituted styryl groups, halogen groups, a cyano group,

a nitro group, and a hydroxyl group.

[0050] Examples of the substituted or unsubstituted aromatic groups with 6 to 50 nucleus carbon atoms include phenyl, 1-naphthyl, 2-naphthyl, 1-anthryl, 2-anthryl, 9-anthryl, 1-phenanthryl, 2-phenanthryl, 3-phenanthryl, 4-phenanthryl, 9-phenanthryl, 1-naphthaceny, 2-naphthaceny, 9-naphthaceny, 1-pyrenyl, 2-pyrenyl, 4-pyrenyl, 2-biphenyl, 3-biphenyl, 4-biphenyl, p-terphenyl-4-yl, p-terphenyl-3-yl, p-terphenyl-2-yl, m-terphenyl-4-yl, m-terphenyl-3-yl, m-terphenyl-2-yl, o-tolyl, m-tolyl, p-tolyl, p-t-butylphenyl, p-(2-phenylpropyl)phenyl, 3-methyl-2-naphthyl, 4-methyl-1-naphthyl, 4-methyl-1-anthryl, 4'-methylbiphenyl, 4"-t-butyl-p-terphenyl-4-yl, 2-fluorenyl, 9,9-dimethyl-2-fluorenyl and 3-fluoranteny groups.

[0051] Preferred examples thereof include phenyl, 1-naphthyl, 2-naphthyl, 9-phenanthryl, 1-naphthaceny, 2-naphthaceny, 9-naphthaceny, 1-pyrenyl, 2-pyrenyl, 4-pyrenyl, 2-biphenyl, 3-biphenyl, 4-biphenyl, o-tolyl, m-tolyl, p-tolyl, p-t-butylphenyl, 2-fluorenyl, 9,9-dimethyl-2-fluorenyl and 3-fluoranteny groups.

[0052] Examples of the substituted or unsubstituted aromatic heterocyclic groups with 5 to 50 nucleus carbon atoms include 1-pyrrolyl, 2-pyrrolyl, 3-pyrrolyl, pyrazinyl, 2-pyridinyl, 3-pyridinyl, 4-pyridinyl, 1-indolyl, 2-indolyl, 3-indolyl, 4-indolyl, 5-indolyl, 6-indolyl, 7-indolyl, 1-isoindolyl, 2-isoindolyl, 3-isoindolyl, 4-isoindolyl, 5-isoindolyl, 6-isoindolyl, 7-isoindolyl, 2-furyl, 3-furyl, 2-benzofuranyl, 3-benzofuranyl, 4-benzofuranyl, 5-benzofuranyl, 6-benzofuranyl, 7-benzofuranyl, 1-isobenzofuranyl, 3-isobenzofuranyl, 4-isobenzofuranyl, 5-isobenzofuranyl, 6-isobenzofuranyl, 7-isobenzofuranyl, quinolyl, 3-quinolyl, 4-quinolyl, 5-quinolyl, 6-quinolyl, 7-quinolyl, 8-quinolyl, 1-isoquinolyl, 3-isoquinolyl, 4-isoquinolyl, 5-isoquinolyl, 6-isoquinolyl, 7-isoquinolyl, 8-isoquinolyl, 2-quinoxalyl, 3-quinoxalyl, 4-quinoxalyl, 5-quinoxalyl, 6-quinoxalyl, 1-carbazolyl, 2-carbazolyl, 3-carbazolyl, 4-carbazolyl, 9-carbazolyl, 1-phenanthrydyl, 2-phenanthrydyl, 3-phenanthrydyl, 4-phenanthrydyl, 6-phenanthrydyl, 7-phenanthrydyl, 8-phenanthrydyl, 9-phenanthrydyl, 10-phenanthrydyl, 1-acrydyl, 2-acrydyl, 3-acrydyl, 4-acrydyl, 9-acrydyl, 1,7-phenanthroline-2-yl, 1,7-phenanthroline-3-yl, 1,7-phenanthroline-4-yl, 1,7-phenanthroline-5-yl, 1,7-phenanthroline-6-yl, 1,7-phenanthroline-8-yl, 1,7-phenanthroline-9-yl, 1,7-phenanthroline-10-yl, 1,8-phenanthroline-2-yl, 1,8-phenanthroline-3-yl, 1,8-phenanthroline-4-yl, 1,8-phenanthroline-5-yl, 1,8-phenanthroline-6-yl, 1,8-phenanthroline-7-yl, 1,8-phenanthroline-9-yl, 1,8-phenanthroline-10-yl, 1,9-phenanthroline-2-yl, 1,9-phenanthroline-3-yl, 1,9-phenanthroline-4-yl, 1,9-phenanthroline-5-yl, 1,9-phenanthroline-6-yl, 1,9-phenanthroline-7-yl, 1,9-phenanthroline-8-yl, 1,9-phenanthroline-10-yl, 1,10-phenanthroline-2-yl, 1,10-phenanthroline-3-yl, 1,10-phenanthroline-4-yl, 1,10-phenanthroline-5-yl, 2,9-phenanthroline-1-yl, 2,9-phenanthroline-3-yl, 2,9-phenanthroline-4-yl, 2,9-phenanthroline-5-yl, 2,9-phenanthroline-6-yl, 2,9-phenanthroline-7-yl, 2,9-phenanthroline-8-yl, 2,9-phenanthroline-10-yl, 2,8-phenanthroline-1-yl, 2,8-phenanthroline-3-yl, 2,8-phenanthroline-4-yl, 2,8-phenanthroline-5-yl, 2,8-phenanthroline-6-yl, 2,8-phenanthroline-7-yl, 2,8-phenanthroline-9-yl, 2,8-phenanthroline-10-yl, 2,7-phenanthroline-1-yl, 2,7-phenanthroline-3-yl, 2,7-phenanthroline-4-yl, 2,7-phenanthroline-5-yl, 2,7-phenanthroline-6-yl, 2,7-phenanthroline-8-yl, 2,7-phenanthroline-9-yl, 2,7-phenanthroline-10-yl, 1-phenazinyl, 2-phenazinyl, 1-phenothiazinyl, 2-phenothiazinyl, 3-phenothiazinyl, 4-phenothiazinyl, 10-phenothiazinyl, 1-phenoxazinyl, 2-phenoxazinyl, 3-phenoxazinyl, 4-phenoxazinyl, 10-phenoxazinyl, 2-oxazolyl, 4-oxazolyl, 5-oxazolyl, 2-oxadiazolyl, 5-oxadiazolyl, 3-furazanyl, 2-thienyl, 3-thienyl, 2-methylpyrrolyl-1-yl, 2-methylpyrrolyl-3-yl, 2-methylpyrrolyl-4-yl, 2-methylpyrrolyl-5-yl, 3-methylpyrrolyl-1-yl, 3-methylpyrrolyl-2-yl, 3-methylpyrrolyl-4-yl, 3-methylpyrrolyl-5-yl, 2-t-butylpyrrolyl-4-yl, 3-(2-phenylpropyl)pyrrolyl-1-yl, 2-methyl-1-indolyl, 4-methyl-1-indolyl, 2-methyl-3-indolyl, 4-methyl-3-indolyl, 2-t-butyl 1-indolyl, 4-t-butyl 1-indolyl, 2-t-butyl 3-indolyl, and 4-t-butyl 3-indolyl groups.

[0053] Examples of the substituted or unsubstituted alkyl groups with 1 to 50 carbon atoms include methyl, ethyl, propyl, isopropyl, n-butyl, s-butyl, isobutyl, t-butyl, n-pentyl, n-hexyl, n-heptyl, n-octyl, hydroxymethyl, 1-hydroxyethyl, 2-hydroxyethyl, 2-hydroxyisobutyl, 1,2-dihydroxyethyl, 1,3-dihydroxyisopropyl, 2,3-dihydroxy-t-butyl, 1,2,3-trihydroxypropyl, chloromethyl, 1-chloroethyl, 2-chloroethyl, 2-chloroisobutyl, 1,2-dichloroethyl, 1,3-dichloroisopropyl, 2,3-dichloro-t-butyl, 1,2,3-trichloropropyl, bromomethyl, 1-bromoethyl, 2-bromoethyl, 2-bromoisobutyl, 1,2-dibromoethyl, 1,3-dibromoisopropyl, 2,3-dibromo-t-butyl, 1,2,3-tribromopropyl, iodomethyl, 1-iodoethyl, 2-iodoethyl, 2-iodoisobutyl, 1,2-diiodoethyl, 1,3-diiodoisopropyl, 2,3-diiodo-t-butyl, 1,2,3-triiodopropyl, aminomethyl, 1-aminoethyl, 2-aminoethyl, 2-aminoisobutyl, 1,2-diaminoethyl, 1,3-diaminoisopropyl, 2,3-diamino-t-butyl, 1,2,3-triaminopropyl, cyanomethyl, 1-cyanoethyl, 2-cyanoethyl, 2-cyanoisobutyl, 1,2-dicyanoethyl, 1,3-dicyanoisopropyl, 2,3-dicyano-t-butyl, 1,2,3-tricyanopropyl, nitromethyl, 1-nitroethyl, 2-nitroethyl, 2-nitroisobutyl, 1,2-dinitroethyl, 1,3-dinitroisopropyl, 2,3-dinitro-t-butyl, 1,2,3-trinitropropyl, cyclopropyl, cyclobutyl, cyclopentyl, cyclohexyl, 4-methylcyclohexyl, 1-adamantyl, 2-adamantyl, 1-norbornyl, and 2-norbornyl groups.

[0054] The substituted or unsubstituted alkoxy groups with 1 to 50 carbon atoms are groups represented by -OY. Examples of Y include methyl, ethyl, propyl, isopropyl, n-butyl, s-butyl, isobutyl, t-butyl, n-pentyl, n-hexyl, n-heptyl, n-octyl, hydroxymethyl, 1-hydroxyethyl, 2-hydroxyethyl, 2-hydroxyisobutyl, 1,2-dihydroxyethyl, 1,3-dihydroxyisopropyl, 2,3-dihydroxy-t-butyl, 1,2,3-trihydroxypropyl, chloromethyl, 1-chloroethyl, 2-chloroethyl, 2-chloroisobutyl, 1,2-dichloroethyl, 1,3-dichloroisopropyl, 2,3-dichloro-t-butyl, 1,2,3-trichloropropyl, bromomethyl, 1-bromoethyl, 2-bromoethyl, 2-bromoisobutyl, 1,2-dibromoethyl, 1,3-dibromoisopropyl, 2,3-dibromo-t-butyl, 1,2,3-tribromopropyl, iodomethyl, 1-iodoethyl, 2-iodoethyl, 2-iodoisobutyl, 1,2-diiodoethyl, 1,3-diiodoisopropyl, 2,3-diiodo-t-butyl, 1,2,3-triiodopropyl, aminomethyl, 1-aminoethyl, 2-aminoethyl, 2-aminoisobutyl, 1,2-diaminoethyl, 1,3-diaminoisopropyl, 2,3-diamino-t-butyl, 1,2,3-triamino-

propyl, cyanomethyl, 1-cyanoethyl, 2-cyanoethyl, 2-cyanoisobutyl, 1,2-dicyanoethyl, 1,3-dicyanoisopropyl, 2,3-dicyano-t-butyl, 1,2,3-tricyanopropyl, nitromethyl, 1-nitroethyl, 2-nitroethyl, 2-nitroisobutyl, 1,2-dinitroethyl, 1,3-dinitroisopropyl, 2,3-dinitro-t-butyl, and 1,2,3-trinitropropyl groups.

[0055] Examples of the substituted or unsubstituted aralkyl groups with 1 to 50 carbon atoms include benzyl, 1-phenylethyl, 2-phenylethyl, 1-phenylisopropyl, 2-phenylisopropyl, phenyl-t-butyl, α -naphthylmethyl, 1- α -naphthylethyl, 2- α -naphthylethyl, 1- α -naphthylisopropyl, 2- α -naphthylisopropyl, β -naphthylmethyl, 1- β -naphthylethyl, 2- β -naphthylethyl, 1- β -naphthylisopropyl, 2- β -naphthylisopropyl, 1-pyrrolylmethyl, 2-(1-pyrrolyl)ethyl, p-methylbenzyl, m-methylbenzyl, o-methylbenzyl, p-chlorobenzyl, m-chlorobenzyl, o-chlorobenzyl, p-bromobenzyl, m-bromobenzyl, o-bromobenzyl, p-iodobenzyl, m-iodobenzyl, o-iodobenzyl, p-hydroxybenzyl, m-hydroxybenzyl, o-hydroxybenzyl, p-aminobenzyl, m-aminobenzyl, o-aminobenzyl, p-nitrobenzyl, m-nitrobenzyl, o-nitrobenzyl, p-cyanobenzyl, m-cyanobenzyl, o-cyanobenzyl, 1-hydroxy-2-phenylisopropyl, and 1-chloro-2-phenylisopropyl groups.

[0056] The substituted or unsubstituted aryloxy groups with 5 to 50 nucleus atoms are represented by -OY'. Examples of Y' include phenyl, 1-naphthyl, 2-naphthyl, 1-anthryl, 2-anthryl, 9-anthryl, 1-phenanthryl, 2-phenanthryl, 3-phenanthryl, 4-phenanthryl, 9-phenanthryl, 1-naphthaceny, 2-naphthaceny, 9-naphthaceny, 1-pyrenyl, 2-pyrenyl, 4-pyrenyl, 2-biphenyl, 3-biphenyl, 4-biphenyl, p-terphenyl-4-yl, p-terphenyl-3-yl, p-terphenyl-2-yl, m-terphenyl-4-yl, m-terphenyl-3-yl, m-terphenyl-2-yl, o-tolyl, m-tolyl, p-tolyl, p-t-butylphenyl, p-(2-phenylpropyl)phenyl, 3-methyl-2-naphthyl, 4-methyl-1-naphthyl, 4-methyl-1-anthryl, 4'-methylbiphenyl, 4"-t-butyl-p-terphenyl-4-yl, 2-pyrrolyl, 3-pyrrolyl, pyrazinyl, 2-pyridinyl, 3-pyridinyl, 4-pyridinyl, 2-indolyl, 3-indolyl, 4-indolyl, 5-indolyl, 6-indolyl, 7-indolyl, 1-isoindolyl, 3-isoindolyl, 4-isoindolyl, 5-isoindolyl, 6-isoindolyl, 7-isoindolyl, 2-furyl, 3-furyl, 2-benzofuranyl, 3-benzofuranyl, 4-benzofuranyl, 5-benzofuranyl, 6-benzofuranyl, 7-benzofuranyl, 1-isobenzofuranyl, 3-isobenzofuranyl, 4-isobenzofuranyl, 5-isobenzofuranyl, 6-isobenzofuranyl, 7-isobenzofuranyl, 2-quinolyl, 3-quinolyl, 4-quinolyl, 5-quinolyl, 6-quinolyl, 7-quinolyl, 8-quinolyl, 1-isoquinolyl, 3-isoquinolyl, 4-isoquinolyl, 5-isoquinolyl, 6-isoquinolyl, 7-isoquinolyl, 8-isoquinolyl, 2-quinoxalyl, 5-quinoxalyl, 6-quinoxalyl, 1-carbazolyl, 2-carbazolyl, 3-carbazolyl, 4-carbazolyl, 1-phenanthrydyl, 2-phenanthrydyl, 3-phenanthrydyl, 4-phenanthrydyl, 6-phenanthrydyl, 7-phenanthrydyl, 8-phenanthrydyl, 9-phenanthrydyl, 10-phenanthrydyl, 1-acrydyl, 2-acrydyl, 3-acrydyl, 4-acrydyl, 9-acrydyl, 1,7-phenanthroline-2-yl, 1,7-phenanthroline-3-yl, 1,7-phenanthroline-4-yl, 1,7-phenanthroline-5-yl, 1,7-phenanthroline-6-yl, 1,7-phenanthroline-8-yl, 1,7-phenanthroline-9-yl, 1,7-phenanthroline-10-yl, 1,8-phenanthroline-2-yl, 1,8-phenanthroline-3-yl, 1,8-phenanthroline-4-yl, 1,8-phenanthroline-5-yl, 1,8-phenanthroline-6-yl, 1,8-phenanthroline-7-yl, 1,8-phenanthroline-9-yl, 1,8-phenanthroline-10-yl, 1,9-phenanthroline-2-yl, 1,9-phenanthroline-3-yl, 1,9-phenanthroline-4-yl, 1,9-phenanthroline-5-yl, 1,9-phenanthroline-6-yl, 1,9-phenanthroline-7-yl, 1,9-phenanthroline-8-yl, 1,9-phenanthroline-10-yl, 1,10-phenanthroline-2-yl, 1,10-phenanthroline-3-yl, 1,10-phenanthroline-4-yl, 1,10-phenanthroline-5-yl, 2,9-phenanthroline-1-yl, 2,9-phenanthroline-3-yl, 2,9-phenanthroline-4-yl, 2,9-phenanthroline-5-yl, 2,9-phenanthroline-6-yl, 2,9-phenanthroline-7-yl, 2,9-phenanthroline-8-yl, 2,9-phenanthroline-10-yl, 2,8-phenanthroline-1-yl, 2,8-phenanthroline-3-yl, 2,8-phenanthroline-4-yl, 2,8-phenanthroline-5-yl, 2,8-phenanthroline-6-yl, 2,8-phenanthroline-7-yl, 2,8-phenanthroline-9-yl, 2,8-phenanthroline-10-yl, 2,7-phenanthroline-1-yl, 2,7-phenanthroline-3-yl, 2,7-phenanthroline-4-yl, 2,7-phenanthroline-5-yl, 2,7-phenanthroline-6-yl, 2,7-phenanthroline-8-yl, 2,7-phenanthroline-9-yl, 2,7-phenanthroline-10-yl, 1-phenazinyl, 2-phenazinyl, 1-phenothiazinyl, 2-phenothiazinyl, 3-phenothiazinyl, 4-phenothiazinyl, 1-phenoxazinyl, 2-phenoxazinyl, 3-phenoxazinyl, 4-phenoxazinyl, 2-oxazolyl, 4-oxazolyl, 5-oxazolyl, 2-oxadiazolyl, 5-oxadiazolyl, 3-furazanyl, 2-thienyl, 3-thienyl, 2-methylpyrrole-1-yl, 2-methylpyrrole-3-yl, 2-methylpyrrole-4-yl, 2-methylpyrrole-5-yl, 3-methylpyrrole-1-yl, 3-methylpyrrole-2-yl, 3-methylpyrrole-4-yl, 3-methylpyrrole-5-yl, 2-t-butylpyrrole-4-yl, 3-(2-phenylpropyl)pyrrole-1-yl, 2-methyl-1-indolyl, 4-methyl-1-indolyl, 2-methyl-3-indolyl, 4-methyl-3-indolyl, 2-t-butyl 1-indolyl, 4-t-butyl 1-indolyl, 2-t-butyl 3-indolyl, and 4-t-butyl 3-indolyl groups.

[0057] The substituted or unsubstituted arylthio groups with 5 to 50 nucleus atoms are represented by -SY", and examples of Y" include phenyl, 1-naphthyl, 2-naphthyl, 1-anthryl, 2-anthryl, 9-anthryl, 1-phenanthryl, 2-phenanthryl, 3-phenanthryl, 4-phenanthryl, 9-phenanthryl, 1-naphthaceny, 2-naphthaceny, 9-naphthaceny, 1-pyrenyl, 2-pyrenyl, 4-pyrenyl, 2-biphenyl, 3-biphenyl, 4-biphenyl, p-terphenyl-4-yl, p-terphenyl-3-yl, p-terphenyl-2-yl, m-terphenyl-4-yl, m-terphenyl-3-yl, m-terphenyl-2-yl, o-tolyl, m-tolyl, p-tolyl, p-t-butylphenyl, p-(2-phenylpropyl)phenyl, 3-methyl-2-naphthyl, 4-methyl-1-naphthyl, 4-methyl-1-anthryl, 4'-methylbiphenyl, 4"-t-butyl-p-terphenyl-4-yl, 2-pyrrolyl, 3-pyrrolyl, pyrazinyl, 2-pyridinyl, 3-pyridinyl, 4-pyridinyl, 2-indolyl, 3-indolyl, 4-indolyl, 5-indolyl, 6-indolyl, 7-indolyl, 1-isoindolyl, 3-isoindolyl, 4-isoindolyl, 5-isoindolyl, 6-isoindolyl, 7-isoindolyl, 2-furyl, 3-furyl, 2-benzofuranyl, 3-benzofuranyl, 4-benzofuranyl, 5-benzofuranyl, 6-benzofuranyl, 7-benzofuranyl, 1-isobenzofuranyl, 3-isobenzofuranyl, 4-isobenzofuranyl, 5-isobenzofuranyl, 6-isobenzofuranyl, 7-isobenzofuranyl, 2-quinolyl, 3-quinolyl, 4-quinolyl, 5-quinolyl, 6-quinolyl, 7-quinolyl, 8-quinolyl, 1-isoquinolyl, 3-isoquinolyl, 4-isoquinolyl, 5-isoquinolyl, 6-isoquinolyl, 7-isoquinolyl, 8-isoquinolyl, 2-quinoxalyl, 5-quinoxalyl, 6-quinoxalyl, 1-carbazolyl, 2-carbazolyl, 3-carbazolyl, 4-carbazolyl, 1-phenanthrydyl, 2-phenanthrydyl, 3-phenanthrydyl, 4-phenanthrydyl, 6-phenanthrydyl, 7-phenanthrydyl, 8-phenanthrydyl, 9-phenanthrydyl, 10-phenanthrydyl, 1-acrydyl, 2-acrydyl, 3-acrydyl, 4-acrydyl, 9-acrydyl, 1,7-phenanthroline-2-yl, 1,7-phenanthroline-3-yl, 1,7-phenanthroline-4-yl, 1,7-phenanthroline-5-yl, 1,7-phenanthroline-6-yl, 1,7-phenanthroline-8-yl, 1,7-phenanthroline-9-yl, 1,7-phenanthroline-10-yl, 1,8-phenanthroline-2-yl, 1,8-phenanthroline-3-yl, 1,8-phen-

anthroline-4-yl, 1,8-phenanthroline-5-yl, 1,8-phenanthroline-6-yl, 1,8-phenanthroline-7-yl, 1,8-phenanthroline-9-yl, 1,8-phenanthroline-10-yl, 1,9-phenanthroline-2-yl, 1,9-phenanthroline-3-yl, 1,9-phenanthroline-4-yl, 1,9-phenanthroline-5-yl, 1,9-phenanthroline-6-yl, 1,9-phenanthroline-7-yl, 1,9-phenanthroline-8-yl, 1,9-phenanthroline-10-yl, 1,10-phenanthroline-2-yl, 1,10-phenanthroline-3-yl, 1,10-phenanthroline-4-yl, 1,10-phenanthroline-5-yl, 2,9-phenanthroline-1-yl, 2,9-phenanthroline-3-yl, 2,9-phenanthroline-4-yl, 2,9-phenanthroline-5-yl, 2,9-phenanthroline-6-yl, 2,9-phenanthroline-7-yl, 2,9-phenanthroline-8-yl, 2,9-phenanthroline-10-yl, 2,8-phenanthroline-1-yl, 2,8-phenanthroline-3-yl, 2,8-phenanthroline-4-yl, 2,8-phenanthroline-5-yl, 2,8-phenanthroline-6-yl, 2,8-phenanthroline-7-yl, 2,8-phenanthroline-9-yl, 2,8-phenanthroline-10-yl, 2,7-phenanthroline-1-yl, 2,7-phenanthroline-3-yl, 2,7-phenanthroline-4-yl, 2,7-phenanthroline-5-yl, 2,7-phenanthroline-6-yl, 2,7-phenanthroline-8-yl, 2,7-phenanthroline-9-yl, 2,7-phenanthroline-10-yl, 1-phenazinyl, 2-phenazinyl, 1-phenothiazinyl, 2-phenothiazinyl, 3-phenothiazinyl, 4-phenothiazinyl, 1-phenoxazinyl, 2-phenoxazinyl, 3-phenoxazinyl, 4-phenoxazinyl, 2-oxazolyl, 4-oxazolyl, 5-oxazolyl, 2-oxadiazolyl, 5-oxadiazolyl, 3-furazanyl, 2-thienyl, 3-thienyl, 2-methylpyrrole-1-yl, 2-methylpyrrole-3-yl, 2-methylpyrrole-4-yl, 2-methylpyrrole-5-yl, 3-methylpyrrole-1-yl, 3-methylpyrrole-2-yl, 3-methylpyrrole-4-yl, 3-methylpyrrole-5-yl, 2-t-butylpyrrole-4-yl, 3-(2-phenylpropyl)pyrrole-1-yl, 2-methyl-1-indolyl, 4-methyl-1-indolyl, 2-methyl-3-indolyl, 4-methyl-3-indolyl, 2-t-butyl 1-indolyl, 4-t-butyl 1-indolyl, 2-t-butyl 3-indolyl, and 4-t-butyl 3-indolyl groups.

[0058] The substituted or unsubstituted carboxyl groups with 1 to 50 carbon atoms are represented by -COOZ, and examples of Z include methyl, ethyl, propyl, isopropyl, n-butyl, s-butyl, isobutyl, t-butyl, n-pentyl, n-hexyl, n-heptyl, n-octyl, hydroxymethyl, 1-hydroxyethyl, 2-hydroxyethyl, 2-hydroxyisobutyl, 1,2-dihydroxyethyl, 1,3-dihydroxyisopropyl, 2,3-dihydroxy-t-butyl, 1,2,3-trihydroxypropyl, chloromethyl, 1-chloroethyl, 2-chloroethyl, 2-chloroisobutyl, 1,2-dichloroethyl, 1,3-dichloroisopropyl, 2,3-dichloro-t-butyl, 1,2,3-trichloropropyl, bromomethyl, 1-bromoethyl, 2-bromoethyl, 2-bromoisobutyl, 1,2-dibromoethyl, 1,3-dibromoisopropyl, 2,3-dibromo-t-butyl, 1,2,3-tribromopropyl, iodomethyl, 1-iodoethyl, 2-iodoethyl, 2-iodoisobutyl, 1,2-diiodoethyl, 1,3-diiodoisopropyl, 2,3-diiodo-t-butyl, 1,2,3-triiodopropyl, aminomethyl, 1-aminoethyl, 2-aminoethyl, 2-aminoisobutyl, 1,2-diaminoethyl, 1,3-diaminoisopropyl, 2,3-diamino-t-butyl, 1,2,3-triaminopropyl, cyanomethyl, 1-cyanoethyl, 2-cyanoethyl, 2-cyanoisobutyl, 1,2-dicyanoethyl, 1,3-dicyanoisopropyl, 2,3-dicyano-t-butyl, 1,2,3-tricyanopropyl, nitromethyl, 1-nitroethyl, 2-nitroethyl, 2-nitroisobutyl, 1,2-dinitroethyl, 1,3-dinitroisopropyl, 2,3-dinitro-t-butyl, and 1, 2, 3-trinitropropyl groups.

[0059] Examples of the substituted or unsubstituted styryl groups include 2-phenyl-1-vinyl, 2,2-diphenyl-1-vinyl, and 1,2,2-triphenyl-1-vinyl groups.

[0060] Examples of the halogen groups include fluorine, chlorine, bromine and iodine.

1 is an integer of 1 to 5, preferably 1 to 2. m is an integer of 0 to 6, preferably 0 to 4.

[0061] Ar¹s may be the same as or different from each other when 1 is 2 or more, and Xs may be the same as or different from each other when m is 2 or more.

[0062] In the organic emitting layer, its emission capability can be improved by adding a fluorescent compound as a dopant. The dopant may be a dopant known as a luminescent material having a long lifetime. It is preferred to use, as the dopant material of the luminescent material, a material represented by the formula (2):

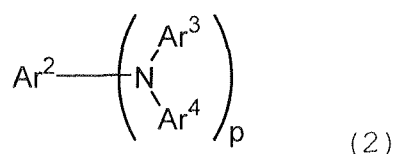

wherein Ar² to Ar⁴ are each a substituted or unsubstituted aromatic group with 6 to 50 nucleus carbon atoms, or a substituted or unsubstituted styryl group; and p is an integer of 1 to 4.

[0063] Examples of the substituted or unsubstituted aromatic group with 6 to 50 nucleus carbon atoms include phenyl, 1-naphthyl, 2-naphthyl, 1-anthryl, 2-anthryl, 9-anthryl, 1-phenanthryl, 2-phenanthryl, 3-phenanthryl, 4-phenanthryl, 9-phenanthryl, 1-naphthacenyl, 2-naphthacenyl, 9-naphthacenyl, 1-pyrenyl, 2-pyrenyl, 4-pyrenyl, 2-biphenyl, 3-biphenyl, 4-biphenyl, p-terphenyl-4-yl, p-terphenyl-3-yl, p-terphenyl-2-yl, m-terphenyl-4-yl, m-terphenyl-3-yl, m-terphenyl-2-yl, o-tolyl, m-tolyl, p-tolyl, p-t-butylphenyl, p-(2-phenylpropyl)phenyl, 3-methyl-2-naphthyl, 4-methyl-1-naphthyl, 4-methyl-1-anthryl, 4'-methylbiphenyl, 4"-t-butyl-p-terphenyl-4-yl, 2-fluorenyl, 9,9-dimethyl-2-fluorenyl and 3-fluoranteny groups.

[0064] Preferred examples thereof include phenyl, 1-naphthyl, 2-naphthyl, 9-phenanthryl, 1-naphthacenyl, 2-naphthacenyl, 9-naphthacenyl, 1-pyrenyl, 2-pyrenyl, 4-pyrenyl, 2-biphenyl, 3-biphenyl, 4-biphenyl, o-tolyl, m-tolyl, p-tolyl, p-t-butylphenyl, 2-fluorenyl, 9,9-dimethyl-2-fluorenyl and 3-fluoranteny groups.

[0065] Examples of the substituted or unsubstituted styryl group include 2-phenyl-1-vinyl, 2,2-diphenyl-1-vinyl, and 1,2,2-triphenyl-1-vinyl groups.

[0066] p is an integer of 1 to 4; provided that Ar^3 s and Ar^4 s, may be the same as or different from each other when p is 2 or more.

5

(7) Hole injecting/transporting layer

[0067] The hole injecting/transporting layer is a layer to help hole injection into an organic emitting layer and hole transfer into an emitting region. The hole injecting/transporting layer has a large hole mobility and a low ionization energy of usually 5.5 eV or less. The hole injecting/transporting layer is preferably made of a material that can transport holes to the organic emitting layer at a lower electric field intensity. Further, the hole mobility thereof is preferably 10^{-4} $cm^2/V \cdot sec$ or more when an electric field of 10^4 to 10^6 V/cm is applied.

10

[0068] The material for forming the hole injecting/transporting layer can be arbitrarily selected from materials which have been widely used as a hole transporting material in photoconductive materials and known materials used in a hole injecting layer of EL devices.

15

[0069] Specific examples thereof include triazole derivatives (see USP No. 3,112,197 and others), oxadiazole derivatives (see USP No. 3,189,447 and others), imidazole derivatives (see JP-B-37-16096 and others), polyaryalkane derivatives (see USP Nos. 3,615,402, 3,820,989 and 3,542,544, JP-B-45-555 and 51-10983, JP-A-51-93224, 55-17105, 56-4148, 55-108667, 55-156953 and 56-36656, and others), pyrolozine derivatives and pyrolozone derivatives (see USP Nos. 3,180,729 and 4,278,746, JP-A-55-88064, 55-88065, 49-105537, 55-51086, 56-80051, 56-88141, 57-45545, 54-112637 and 55-74546, and others), phenylene diamine derivatives (see USP No. 3,615,404, JP-B-51-10105, 46-3712 and 47-25336, JP-A-54-53435, 54-110536 and 54-119925, and others), arylamine derivatives (see USP Nos. 3,567,450, 3,180,703, 3,240,597, 3,658,520, 4,232,103, 4,175,961 and 4,012,376, JP-B-49-35702 and 39-27577, JP-A-55-144250, 56-119132 and 56-22437, DE1,110,518, and others), amino-substituted chalcone derivatives (see USP No. 3,526,501, and others), oxazole derivatives (ones disclosed in USP No. 3,257,203, and others), styrylanthracene derivatives (see JP-A-56-46234, and others), fluorenone derivatives (JP-A-54-110837, and others), hydrazone derivatives (see USP Nos. 3,717,462, JP-A-54-59143, 55-52063, 55-52064, 55-46760, 55-85495, 57-11350, 57-148749 and 2-311591, and others), styrene derivatives (see JP-A-61-210363, 61-228451, 61-14642, 61-72255, 62-47646, 62-36674, 62-10652, 62-30255, 60-93455, 60-94462, 60-174749 and 60-175052, and others), silazane derivatives (USP No. 4,950,950), polysilanes (JP-A-2-204996), aniline copolymers (JP-A-2-282263), and electroconductive macromolecular oligomers (in particular thiophene oligomers) disclosed in JP-A-1-211399.

20

25

30

[0070] The above substances can be used as the material of the hole-injecting layer. The following is preferably used: porphyrin compounds (disclosed in JP-A-63-2956965 and others), aromatic tertiary amine compounds and styrylamine compounds (see USP No. 4,127,412, JP-A-53-27033, 54-58445, 54-149634, 54-64299, 55-79450, 55-144250, 56-119132, 61-295558, 61-98353 and 63-295695, and others), in particular, the aromatic tertiary amine compounds.

35

The following can also be given as examples: 4,4'-bis(N-(1-naphthyl)-N-phenylamino)biphenyl (hereinafter referred to as NPD), which has in the molecule thereof two condensed aromatic rings, disclosed in USP No. 5,061,569, and 4,4',4"-tris(N-(3-methylphenyl)-N-phenylamino)triphenylamine (hereinafter referred to as MTDATA), wherein three triphenylamine units are linked in a star-burst form, disclosed in JP-A-4-308688.

40

[0071] Inorganic compound such as p-type Si and p-type SiC, as well as the aromatic dimethylidene type compounds described above as the material of the organic emitting layer can also be used as the material of the hole injecting layer.

[0072] The hole injecting/transporting layer can be formed by making the above-mentioned compounds into a thin film by a known method such as vacuum deposition, spin coating, casting or LB technique. The thickness thereof is not particularly limited, and is generally from 5 nm to 5 μm . This hole injecting/transporting layer may be made of a single layer or a stacked layers.

45

[0073] The organic semiconductor layer may be provided as a layer for helping the injection of holes or electrons into the emitting organic layer, and preferably has an electroconductivity of 10^{-10} S/cm or more. The material of such an organic semiconductor layer may be an electroconductive oligomer such as thiophene-containing oligomer or arylamine-containing oligomer disclosed in JP-A-8-193191, or an electroconductive dendrimer such as arylamine-containing dendrimer.

50

An inorganic injecting layer made of an inorganic material may be interposed between an anode and a hole injecting layer to improve carrier injection. Materials for the inorganic injecting layer include aluminum oxide, aluminum nitride, titanium oxide, silicon oxide, germanium oxide, silicon nitride, boron nitride, molybdenum oxide, ruthenium oxide, and vanadium oxide.

55

(8) Electron-transporting layer

[0074] An electron-transporting layer may be provided between the cathode and the emitting layer.

The thickness of electron-transporting layer may be properly selected from several nm to several μm but is preferably selected such that the electron mobility is 10^{-5} cm^2/Vs or more when applied with an electric field of 10^4 to 10^6 V/cm .

[0075] The material used in the electron-transporting layer is preferably a metal complex of 8-hydroxyquinoline or a derivative thereof.

5 Specific examples of the above-mentioned metal complex of 8-hydroxyquinoline or derivative thereof include metal chelate oxynoid compounds containing a chelate of oxine (generally, 8-quinolinol or 8-hydroxyquinoline).

[0076] For example, Alq as described regarding the emitting material can be used for the electron-injecting layer.

[0077] Examples of the oxadiazole derivative include electron-transferring compounds represented by the following general formulas.

10

15

20

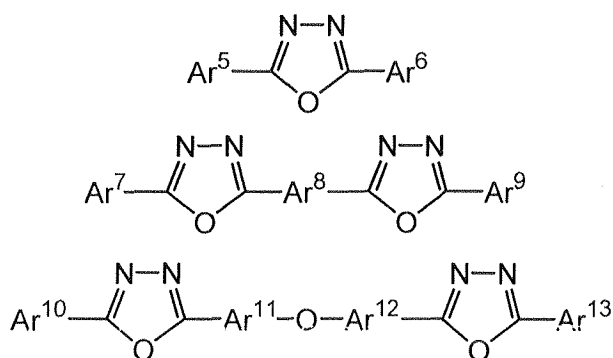

25 wherein Ar^5 , Ar^6 , Ar^7 , Ar^9 , Ar^{10} and Ar^{13} each represent a substituted or unsubstituted aryl group and may be the same or different, and Ar^8 , Ar^{11} and Ar^{12} represent a substituted or unsubstituted arylene group and may be the same or different.

[0078] Examples of the aryl group include phenyl, biphenyl, anthranyl, perylenyl, and pyrenyl groups. Examples of the arylene group include phenylene, naphthylene, biphenylene, anthranylene, perylenylene, and pyrenylene groups.

30 Examples of the substituent include alkyl groups with 1 to 10 carbon atoms, alkoxy groups with 1 to 10 carbon atoms, and a cyano group. The electron-transferring compounds are preferably ones having capability of forming a thin film.

[0079] Specific examples of the electron-transferring compounds include the following.

35

40

45

50

55

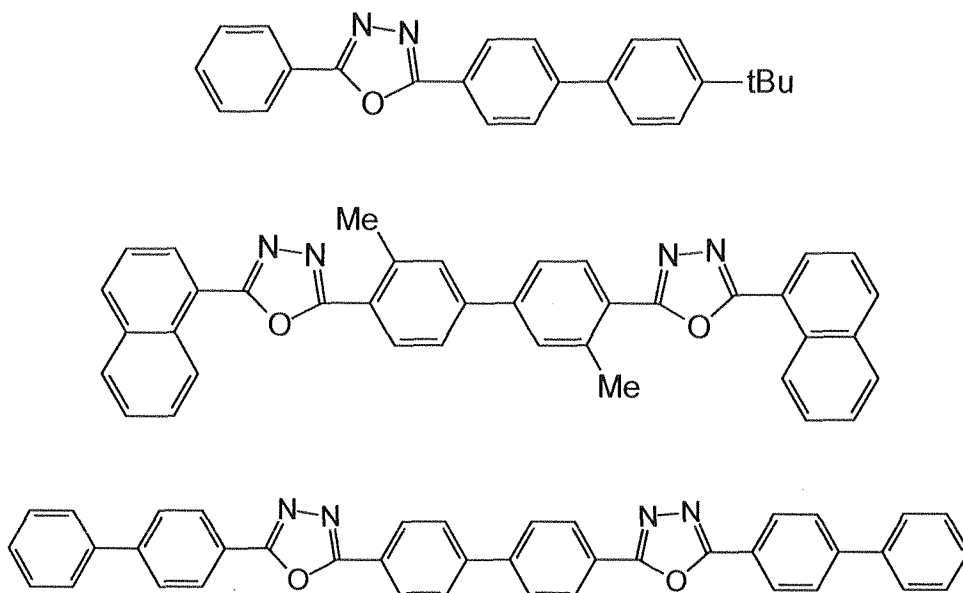

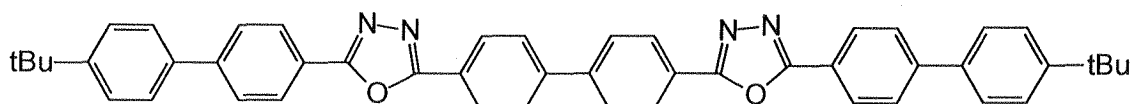

5

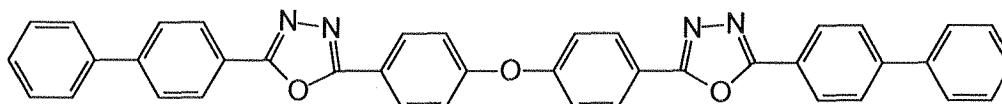

10

[0080] Examples of the semiconductor for forming the electron-transporting layer include oxides, nitrides or oxynitrides containing at least one element selected from Ba, Ca, Sr, Yb, Al, Ga, In, Li, Na, Cd, Mg, Si, Ta, Sb and Zn, and combinations of two or more thereof. For inorganic compounds forming the electron-transporting layer, preferred is a microcrystalline or amorphous insulative thin film. If the electron-transporting layer is formed of the insulative thin film, a more uniform thin film can be formed to reduce pixel defects such as dark spots. The inorganic compounds include alkali metal calcogenides, alkaline earth metal calcogenides, halides of alkali metals, and halides of alkaline earth metals.

15

20

(9) Electron-injecting layer

[0081] The electron-injecting layer is a layer to help electron injection into the organic emitting layer and has large electron mobility. An adhesion improving layer is a particular electron-injecting layer made of a material enabling good adhesion to a cathode. Examples of electron-injecting compounds are given below.

25

[0082] Nitrogen-containing heterocyclic derivatives represented by the following formula, disclosed in Japanese patent application 2003-005184:

30

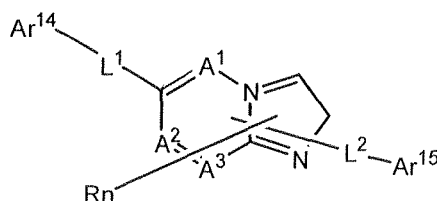

35

wherein A¹ to A³ are a nitrogen atom or a carbon atom;

40

R is an aryl group having 6 to 60 carbon atoms which may have a substituent, a heteroaryl group having 3 to 60 carbon atoms which may have a substituent, an alkyl group having 1 to 20 carbon atoms, a haloalkyl group having 1 to 20 carbon atoms or an alkoxy group having 1 to 20 carbon atoms; n is an integer of 0 to 5; when n is an integer of 2 or more, Rs may be the same or different;

45

adjacent Rs may be bonded to each other to form a substituted or unsubstituted carbon aliphatic ring or a substituted or unsubstituted carbon aromatic ring;

50

Ar¹⁴ is an aryl group having 6 to 60 carbon atoms which may have a substituent or a heteroaryl group having 3 to 60 carbon atoms which may have a substituent;

55

Ar¹⁵ is a hydrogen atom, an alkyl group having 1 to 20 carbon atoms, a haloalkyl group having 1 to 20 carbon atoms, an alkoxy group having 1 to 20 carbon atoms, an aryl group having 6 to 60 carbon atoms which may have a substituent or a heteroaryl group having 3 to 60 carbon atoms which may have a substituent;

60

provided that one of Ar¹⁴ and Ar¹⁵ is a condensed ring having 10 to 60 carbon atoms which may have a substituent or a hetero condensed ring having 3 to 60 carbon atoms which may have a substituent; and

65

L¹ and L² are independently a single bond, a condensed ring having 6 to 60 carbon atoms which may have a substituent, a hetero condensed ring having 3 to 60 carbon atoms which may have a substituent or a fluorenylene group which may have a substituent.

70

[0083] Nitrogen-containing heterocyclic derivatives represented by the following formula, disclosed in Japanese patent application 2003-004193:

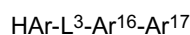

wherein HAr is a nitrogen-containing heterocyclic ring with 3 to 40 carbon atoms which may have a substituent; L³ is a single bond, an arylene group with 6 to 60 carbon atoms which may have a substituent, a heteroarylene group with 3 to 60 carbon atoms which may have a substituent or a fluorenylene group which may have a substituent; Ar¹⁶ is a bivalent aromatic hydrocarbon group with 6 to 60 carbon atoms which may have a substituent; and Ar¹⁷ is an aryl group with 6 to 60 carbon atoms which may have a substituent or a heteroaryl group with 3 to 60 carbon atoms which may have a substituent.

[0084] An electroluminescent device using a silacyclopentadiene derivative represented by the following formula, disclosed in JP-A-09-087616:

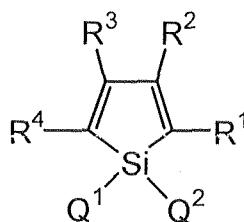

wherein Q¹ and Q² are each a saturated or unsaturated hydrocarbon group with 1 to 6 carbon atoms, an alkoxy group, an alkenyloxy group, an alkynyloxy group, a hydroxyl group, a substituted or unsubstituted aryl group, or a substituted or unsubstituted hetero ring, or Q¹ and Q² are bonded to each other to form a saturated or unsaturated ring; R¹ to R⁴ are each a hydrogen atom, a halogen atom, a substituted or unsubstituted alkyl group with 1 to 6 carbon atoms, an alkoxy group, an aryloxy group, a perfluoroalkyl group, a perfluoroalkoxy group, an amino group, an alkylcarbonyl group, an arylcarbonyl group, an alkoxy carbonyl group, an aryloxy carbonyl group, an azo group, an alkylcarbonyloxy group, an arylcarbonyloxy group, an alkoxy carbonyloxy group, an aryloxy carbonyloxy group, a sulfinyl group, a sulfonyl group, a sulfanyl group, a silyl group, a carbamoyl group, an aryl group, a heterocyclic group, an alkenyl group, an alkynyl group, a nitro group, a formyl group, a nitroso group, a formyloxy group, an isocyano group, a cyanate group, an isocyanate group, a thiocyanate group, an isothiocyanate group or a cyano group, or adjacent groups of R¹ to R⁴ may be joined to form a substituted or unsubstituted condensed ring.

[0085] Silacyclopentadiene derivative represented by the following formula, disclosed in JP-A-09-194487:

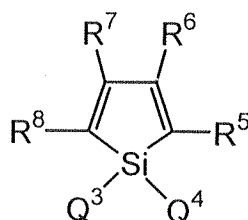

wherein Q³ and Q⁴ are each a saturated or unsaturated hydrocarbon group with 1 to 6 carbon atoms, an alkoxy group, an alkenyloxy group, an alkynyloxy group, a substituted or unsubstituted aryl group, or a substituted or unsubstituted heterocyclic group, or Q³ and Q⁴ bonded to form a saturated or unsaturated ring; and R⁵ to R⁸ are each a hydrogen atom, a halogen atom, a substituted or unsubstituted alkyl group with 1 to 6 carbon atoms, an alkoxy group, an aryloxy group, a perfluoroalkyl group, a perfluoroalkoxy group, an amino group, an alkylcarbonyl group, an arylcarbonyl group, an alkoxy carbonyl group, an aryloxy carbonyl group, an azo group, an alkylcarbonyloxy group, an arylcarbonyloxy group, an alkoxy carbonyloxy group, an aryloxy carbonyloxy group, a sulfinyl group, a sulfonyl group, a sulfanyl group, a silyl group, a carbamoyl group, an aryl group, a heterocyclic group, an alkenyl group, an alkynyl group, a nitro group, a formyl group, a nitroso group, a formyloxy group, an isocyano group, a cyanate group, an isocyanate group, a thiocyanate group, an isothiocyanate group or a cyano group, or adjacent groups of R⁵ to R⁸ bonded to form a substituted or unsubstituted condensed ring structure: provided that in the case where R⁵ and R⁸ are each a phenyl group, Q³ and Q⁴ are neither an alkyl group nor a phenyl group; in the case where R⁵ and R⁸ are each a thienyl group, Q³, Q⁴, R⁶ and R⁷ do not form the structure where Q³ and Q⁴ are a monovalent hydrocarbon group, and at the same time R⁶ and R⁷ are an alkyl group, an aryl group, an alkenyl group, or R⁶ and R⁷ are aliphatic groups which form a ring by bonding to each

EP 1 722 606 A1

other; in the case where R⁵ and R⁸ are a silyl group, R⁶, R⁷, Q³ and Q⁴ are each neither a monovalent hydrocarbon group with 1 to 6 carbon atoms nor a hydrogen atom; and in the case where a benzene ring is condensed at the positions of R⁵ and R⁶, Q³ and Q⁴ are neither an alkyl group nor a phenyl group.

[0086] Borane derivatives represented by the following formula, disclosed in JP-A1-2000-040586:

5

10

15

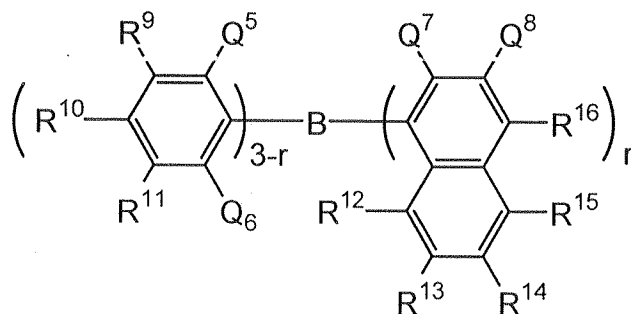

20

25

wherein R⁹ to R¹⁶ and Q⁸ are each a hydrogen atom, a saturated or unsaturated hydrocarbon group, an aromatic group, a heterocyclic group, a substituted amino group, a substituted boryl group, an alkoxy group or an aryloxy group; Q⁵, Q⁶ and Q⁷ are each a saturated or unsaturated hydrocarbon group, an aromatic group, a heterocyclic group, a substituted amino group, an alkoxy group or an aryloxy group; the substituents of Q⁷ and Q⁸ may be bonded to each other to form a condensed ring; r is an integer of 1 to 3, and Q⁷s may be different from each other when r is 2 or more; provided that excluded are the compounds where r is 1, Q⁵, Q⁶ and R¹⁰ are each a methyl group and R¹⁶ is a hydrogen atom or a substituted boryl group, and the compounds where r is 3 and Q⁷ is a methyl group.

[0087] Compounds represented by the following formula, disclosed in JP-A-10-088121:

30

35

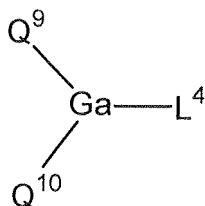

40

45

wherein Q⁹ and Q¹⁰ are independently a ligand represented by the following formula (3); and L⁴ is a halogen atom, a substituted or unsubstituted alkyl group, a substituted or unsubstituted cycloalkyl group, a substituted or unsubstituted aryl group, a substituted or unsubstituted heterocyclic group, -OR¹⁷ wherein R¹⁷ is a hydrogen atom, a substituted or unsubstituted alkyl group, a substituted or unsubstituted cycloalkyl group, a substituted or unsubstituted aryl group or a substituted or unsubstituted heterocyclic group, or -O-Ga-Q¹¹(Q¹²) wherein Q¹¹ and Q¹² are the same ligands as Q⁹ and Q¹⁰.

[0088]

50

55

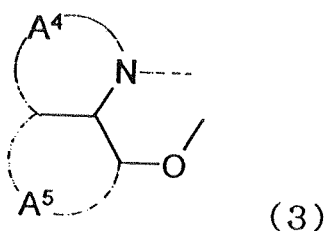

wherein rings A⁴ and A⁵ are each a 6-membered aryl ring structure which may have a substituent, and are condensed to each other.

[0089] The metal complexes have the strong nature of an n-type semiconductor and large ability of injecting electrons. Further the energy generated at the time of forming a complex is small so that a metal is strongly bonded to ligands in the complex formed and the fluorescent quantum efficiency becomes large as the emitting material.

[0090] Specific examples of the substituents of the rings A⁴ and A⁵ which form the ligands of the above formula include halogen atoms such as chlorine, bromine, iodine and fluorine; substituted or unsubstituted alkyl groups such as methyl, ethyl, propyl, butyl, sec-butyl, tert-butyl, pentyl, hexyl, heptyl, octyl, stearyl and trichloromethyl; substituted or unsubstituted aryl groups such as phenyl, naphthyl, 3-methylphenyl, 3-methoxyphenyl, 3-fluorophenyl, 3-trichloromethylphenyl, 3-trifluoromethylphenyl and 3-nitrophenyl; substituted or unsubstituted alkoxy groups such as methoxy, n-butoxy, tert-butoxy, trichloromethoxy, trifluoroethoxy, pentafluoropropoxy, 2,2,3,3-tetrafluoropropoxy, 1,1,1,3,3,3-hexafluoro-2-propoxy and 6-(perfluoroethyl)hexyloxy; substituted or unsubstituted aryloxy groups such as phenoxy, p-nitrophenoxy, p-tert-butylphenoxy, 3-fluorophenoxy, pentafluorophenyl and 3-trifluoromethylphenoxy; substituted or unsubstituted alkylthio groups such as methylthio, ethylthio, tert-butylthio, hexylthio, octylthio and trifluoromethylthio; substituted or unsubstituted arylthio groups such as phenylthio, p-nitrophenylthio, p-tert-butylphenylthio, 3-fluorophenylthio, pentafluorophenylthio and 3-trifluoromethylphenylthio; a cyano group; a nitro group; an amino group; mono or di-substituted amino groups such as methylamino, diethylamino, ethylamino, diethylamino, dipropylamino, dibutylamino and diphenylamino; acylamino groups such as bis(acetoxymethyl)amino, bis(acetoxyethyl)amino, bis(acetoxypropyl)amino and bis(acetoxybutyl)amino; a hydroxy group; a siloxy group; an acyl group; carbamoyl groups such as methylcarbamoyl, dimethylcarbamoyl, ethylcarbamoyl, diethylcarbamoyl, propylcarbamoyl, butylcarbamoyl and phenylcarbamoyl; a carboxylic group; a sulfonic acid group; an imido group; cycloalkyl groups such as cyclopentyl and cyclohexyl; aryl groups such as phenyl, naphthyl, biphenyl, anthranlyl, fluorenyl and pyrenyl; and heterocyclic groups such as pyridinyl, pyrazinyl, pyrimidinyl, pyridazinyl, triazinyl, indolinyl, quinolinyl, acridinyl, pyrrolidinyl, dioxanyl, piperidinyl, morpholidinyl, piperazinyl, triathinyl, carbazolyl, furanyl, thiophenyl, oxazolyl, oxadiazolyl, benzooxazolyl, thiazolyl, thiadiazolyl, benzothiazolyl, triazolyl, imidazolyl, benzoimidazolyl and puranyl. Moreover the above-mentioned substituents may be bonded to each other to form a six-membered aryl or heterocyclic ring.

[0091] In the invention, an electron-injecting layer which is formed of an insulator or a semiconductor may further be provided between a cathode and an organic layer. By providing such an electron-injecting layer, current leakage can be effectively prevented to improve the injection of electrons. As the insulator, the following is preferably used: at least one metal compound selected from the group consisting of alkali metal calcogenides, alkaline earth metal calcogenides, halides of alkali metals and halides of alkaline earth metals. If the electron-injecting layer is formed of these alkali metal calcogenides and the like, its electron-injecting property can be preferably further improved. Preferable alkali metal calcogenides include Li₂O, LiO, Na₂S, Na₂Se and NaO. Preferable alkaline earth metal calcogenides include CaO, BaO, SrO, BeO, BaS and CaSe. Preferable halides of alkali metals include LiF, NaF, KF, LiCl, KCl and NaCl. Preferable halides of alkaline earth metals include fluorides such as CaF₂, BaF₂, SrF₂, MgF₂ and BeF₂ and halides other than fluorides.

(10) Reducing dopant

[0092] A reducing dopant is preferably contained in an electron transporting region or an interface region between a cathode and an organic layer. The reducing dopant is defined as a substance which can reduce electron-transporting compounds. Various substances having certain reducibility can be used. The following can be preferably used: at least one substance selected from alkali metals, alkaline earth metals, rare earth metals, oxides of alkali metals, halides of alkali metals, oxides of alkaline earth metals, halides of alkaline earth metals, oxides of rare earth metals, halides of rare earth metals, organic complexes of alkali metals, organic complexes of alkaline earth metals and organic complexes of rare earth metals.

[0093] Specifically preferable examples of the reducing dopant include at least one alkali metal selected from the group consisting of Na (work function: 2.36 eV), K (work function: 2.28 eV), Rb (work function: 2.16 eV) and Cs (work function: 1.95 eV) or at least one alkaline earth metal selected from the group consisting of Ca (work function: 2.9 eV), Sr (work function: 2.0 to 2.5 eV) and Ba (work function: 2.52 eV). Substances with a work function of 2.9 eV or less are particularly preferred. Among these, the reducing dopant is preferably at least one alkali metal selected from the group consisting of K, Rb and Cs, more preferably Rb or Cs, and most preferably Cs. These alkali metals have particularly high reducing ability. The luminance and lifetime of an organic EL device can be improved by adding a relatively small amount of these alkali metals to the electron injecting region. As the reducing dopant with a work function of 2.9 eV or less, combinations of two or more of these alkali metals are preferable. Combinations with Cs, for example, Cs and Na, Cs and K, Cs and Rb, or Cs, Na and K are particularly preferable. The combination with Cs enables to efficiently exhibit the reducing ability and to improve the luminance and lifetime of an organic EL device by addition thereof to the electron injecting region.

(11)Substrate

[0094] A glass plate, polymer plate and the like are preferably used as a substrate. Soda-lime glass, barium/strontium-containing glass, lead glass, aluminosilicate glass, borosilicate glass, barium borosilicate glass, quartz and the like are preferred as a glass plate. Polycarbonate, acrylic polymer, polyethylene terephthalate, polyethersulfide, polysulfone and the like are preferred as a polymer plate.

[Examples]

Example 1

[0095] An organic EL device shown in FIG. 7a was fabricated as follows.

A glass substrate 60 (25 mm x 75 mm x 1.1 mm in thickness) on which an Ag light reflecting electrode 61 (first light reflecting layer, thickness: 50 nm) was formed in a certain pattern was subjected to ultrasonic cleaning for five minutes in isopropyl alcohol and then subjected to UV ozone cleaning for 30 minutes. The cleaned glass substrate provided with the light reflecting electrode was installed in a substrate holder of a vacuum deposition device, and an IZO as a non-emitting inorganic compound was formed into a film in a thickness of 160 nm (first transparent electrode 62).

[0096] An N,N'-bis(N,N'-diphenyl-4-aminophenyl)-N,N-diphenyl-4,4'-diamino-1,1'-biphenyl film (hereinafter abbreviated as "HI film") and a molybdenum trioxide film were formed at a weight ratio of 40:1 on the surface of the glass substrate on which the linear light reflecting electrode was formed so that the light reflecting electrode was covered. The HI film functioned as a hole injecting layer 63. Following the HI film formation, a 4,4'-bis[N-(1-naphthyl)-N-phenylamino]-biphenyl film (hereinafter abbreviated as "NPD film") was formed on the HI film to a thickness of 60 nm. The NPD film functioned as a hole transporting layer 64. NPD and coumarin 6 were codeposited at a weight ratio of 40:1 to a thickness of 10 nm to form a green organic emitting layer 65. A styryl derivative DPVDPAN and a compound (B1) of the following formulas were deposited at a weight ratio of 40:1 to a thickness of 30 nm to form a blue organic emitting layer 66. Tris(8-quinolinol)aluminum (hereinafter abbreviated as "Alq") and DCJTb of the following formula were codeposited on the resulting film at a weight ratio of 100:1 to a thickness of 20 nm to form a red organic emitting layer 67. After forming an Alq film to a thickness of 10 nm to form an electron transporting layer 68, Li (Li source: manufactured by SAES getters) and Alq were simultaneously deposited to form an Alq:Li film (thickness: 10 nm) as an electron injecting layer 69. IZO was deposited to a thickness of 160 nm on the Alq:Li film and metal Ag was deposited on the Alq:Li film to a thickness of 5 nm to form a second transparent electrode 70 and a light semi-transmitting metal layer 71 (second light reflecting layer). An IZO film was then formed on the light semi-transmitting metal layer 70 to a thickness of 100 nm to form an electrode 72 to obtain an organic EL emitting device. The resulting device emitted white light with a luminance of 100 cd/m², an efficiency of 7 cd/A, and a maximum luminance of 80,000 cd/m² at a direct-current voltage of 5 V. The device formed using the above materials had CIE 1931 chromaticity coordinates of (x,y) = (0.30,0.32), and it was confirmed that the color of light was white.

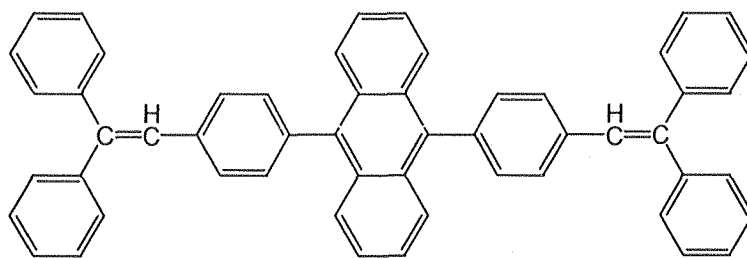
[0097]

DPVDPAN

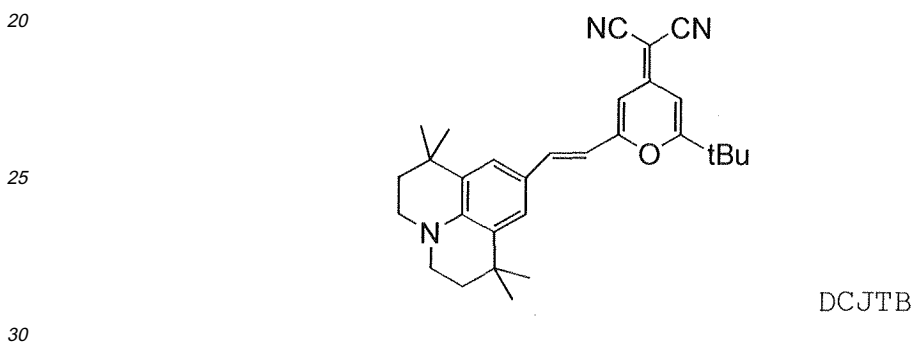
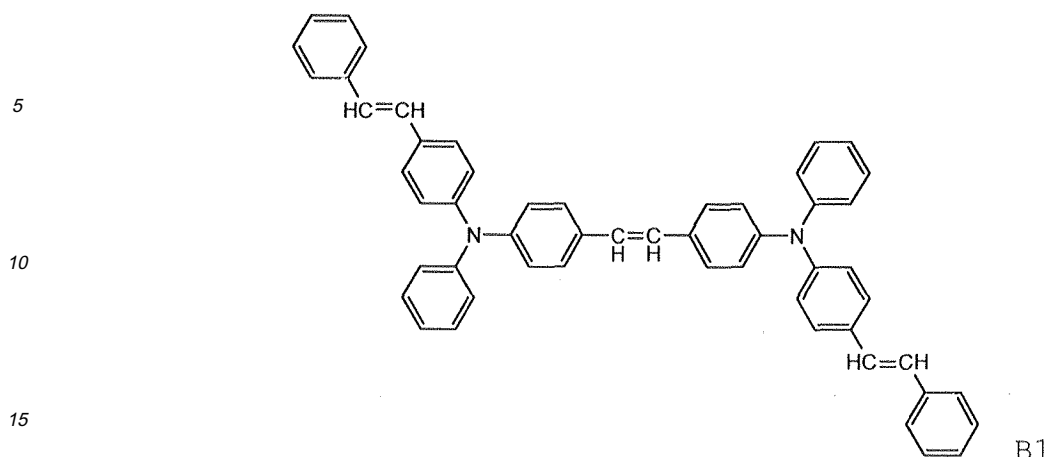

[0098] When applying light with a wavelength of 400 to 800 nm using a white light source (halogen lamp) from the side of the light semi-transmitting metal layer 71 (second light reflecting layer) in a state in which the organic EL device was not driven, it was observed that the spectrum of the reflected light had minimum values at 435 nm (half-width: 25 nm), 510 nm (half-width: 40 nm), and 650 nm (half-width: 75 nm). The spectrum of the reflected light was measured using a spectroscope.

[0099] A glass plate provided with a blue color filter was placed on the device, and the emission properties were evaluated. The chromaticity coordinates were $(x,y) = (0.15,0.10)$. A glass plate provided with a green color filter was placed on the device instead of the glass plate provided with a blue color filter, and the emission properties were evaluated. The chromaticity coordinates were $(x,y) = (0.26,0.65)$. A glass plate provided with a red color filter was placed on the device instead of the glass plate provided with a green color filter, and the emission properties were evaluated. The chromaticity coordinates were $(x,y) = (0.68,0.32)$.

The film thickness between the first and second light reflecting layers (Ag) 61, 71 was 470 nm.

Comparative Example 1

[0100] An organic EL device shown in FIG. 7b was fabricated as follows.

The organic EL device was fabricated in the same manner as in Example 1 except that the IZO film (first transparent electrode), which is of a non-emitting inorganic compound, was not formed on the Ag film 61. As a result, the film thickness between the first and second light reflecting layer (Ag) 61, 71 was 310 nm. The resulting device emitted white light with a luminance of 100 cd/m², an efficiency of 7 cd/A, and a maximum luminance of 80,000 cd/m² at a direct-current voltage of 5 V. The device formed using the above materials had CIE 1931 chromaticity coordinates of $(x,y) = (0.30,0.32)$ and it was confirmed that the color of light was white.

[0101] When applying light with a wavelength of 400 to 800 nm from the side of the light semi-transmitting metal layer 71 (second light reflecting layer) in a state in which the organic EL device was not driven, it was observed that the spectrum of the reflected light had two minimum values at 422 nm (half-width: 35 nm) and 671 nm (half-width: 210 nm).

[0102] The same glass plate provided with a blue color filter as in Example 1 was placed on the device, and the emission properties were evaluated. The chromaticity coordinates were $(x,y) = (0.15,0.12)$. Likewise, a glass plate

provided with a green color filter was placed on the device, and the emission properties were evaluated. The chromaticity coordinates were $(x,y) = (0.32,0.40)$. A glass plate provided with a red color filter was placed on the device, and the emission properties were evaluated. The chromaticity coordinates were $(x,y) = (0.60,0.40)$. The color purity after transmission through the color filter deteriorated in comparison with Example 1.

5

Example 2

[0103] An organic EL device shown in FIG. 7c was fabricated as follows.

Each layer was formed in the same manner as in Example 1, but the order of the layers was changed. Specifically, the films were formed in the order of Ag 61 (first light reflecting layer), IZO (first transparent electrode), Alq:Li, Alq, Alq:DCJTB, DPVDPAN:B1 NPD: Coumarin 6, NPD, and HI. A molybdenum trioxide film (inorganic injecting layer 73) was formed on the HI film to a thickness of 1 nm, and an IZO film (second transparent electrode 62) was formed on the molybdenum trioxide film to a thickness of 100 nm as a non-emitting inorganic compound layer. An $\text{SiO}_{(1-x)}\text{N}_x$ ($x = 0$ to 1) film was formed on the IZO film to a thickness of 200 nm as an insulating non-emitting inorganic compound layer 74.

An Ag film was then formed thereon to a thickness of 5 nm. A metallic substance was not provided between the first and second light reflecting layers (Ag) 61, 71. The film thickness between the first and second light reflecting layers (Ag) 61, 71 was 611 nm.

[0104] When applying light with a wavelength of 400 to 800 nm from the side of the light semi-transmitting metal layer 71 (second light reflecting layer) in a state in which the organic EL device was not driven, it was observed that the spectrum of the reflected light had minimum values at 442 nm (half-width: 20 nm), 494 nm (half-width: 30 nm), 580 nm (half-width: 45 nm), and 730 nm (half-width: 80 nm).

[0105] The same glass plate provided with a blue color filter as in Example 1 was placed on the device, and the emission properties were evaluated. The chromaticity coordinates were $(x,y) = (0.15,0.10)$. Likewise, a glass plate provided with a green color filter was placed on the device, and the emission properties were evaluated. The chromaticity coordinates were $(x,y) = (0.26,0.67)$. A glass plate provided with a red color filter was placed on the device, and the emission properties were evaluated. The chromaticity coordinates were $(x,y) = (0.68,0.32)$.

25

Comparative Example 2

[0106] An organic EL device shown in FIG. 7d was fabricated as follows.

The organic EL device was fabricated in the same manner as in Example 2 except that the $\text{SiO}_{(1-x)}\text{N}_x$ film was not formed and the IZO film 62 (transparent electrode) and the Ag film 71 (second light reflecting layer) were interchanged. The film thickness between the first and second light reflecting layers (Ag) 61, 71 was 411 nm.

[0107] The same glass plate provided with a blue color filter as in Example 1 was placed on the device, and the emission properties were evaluated. The chromaticity coordinates were $(x,y) = (0.15,0.18)$. Likewise, a glass plate provided with a green color filter was placed on the device, and the emission properties were evaluated. The chromaticity coordinates were $(x,y) = (0.32,0.40)$. A glass plate provided with a red color filter was placed on the device, and the emission properties were evaluated. The chromaticity coordinates were $(x,y) = (0.58,0.42)$.

35

The color purity after transmission through the color filter deteriorated in comparison with Example 1.

40

Industrial Utility

[0108] The organic EL device according to the invention may be used for various displays (e.g. consumer and industrial displays such as monochrome and full-color displays for portable telephones, PDAs, car navigation systems, monitors, and TVs), various types of lighting (e.g. backlight), and the like.

45

Claims

1. An organic electroluminescent device comprising at least:

50

- a first light reflecting layer,
- a first transparent electrode,
- an organic emitting layer,
- a second transparent electrode and
- a second light reflecting layer stacked on a substrate in this order;
- at least one of the first light reflecting layer and the second light reflecting layer being light semi-transmissive.

55

EP 1 722 606 A1

2. The organic electroluminescent device according to claim 1, wherein the emission from the organic electroluminescent device has at least 3 peaks in the wavelengths of 400 to 800 nm.
- 5 3. The organic electroluminescent device according to claim 1, wherein a light transmitting protective layer is placed between the second transparent electrode and the second light reflecting layer.
4. The organic electroluminescent device according to claim 1, wherein an average thickness of all layers interposed between the first light reflecting layer and the second light reflecting layer is 100 to 1000 nm.
- 10 5. The organic electroluminescent device according to claim 1, wherein at least one of the first transparent electrode and the second transparent electrode is formed of an oxide of one kind or two or more kinds of elements selected from the group consisting of In, Sn, Zn, and Cd.
- 15 6. The organic electroluminescent device according to claim 1, wherein at least one of the first light reflecting layer and the second light reflecting layer is provided with a light diffusion part.
7. A display comprising the organic electroluminescent device according to claim 1 and a color conversion member.
- 20 8. A display comprising the organic electroluminescent device according to claim 1 and a color filter.

25

30

35

40

45

50

55

FIG. 1

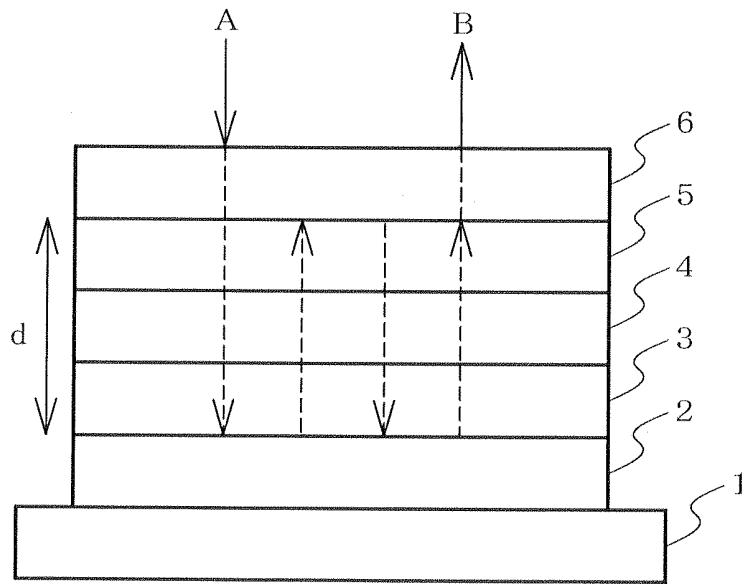

FIG. 2

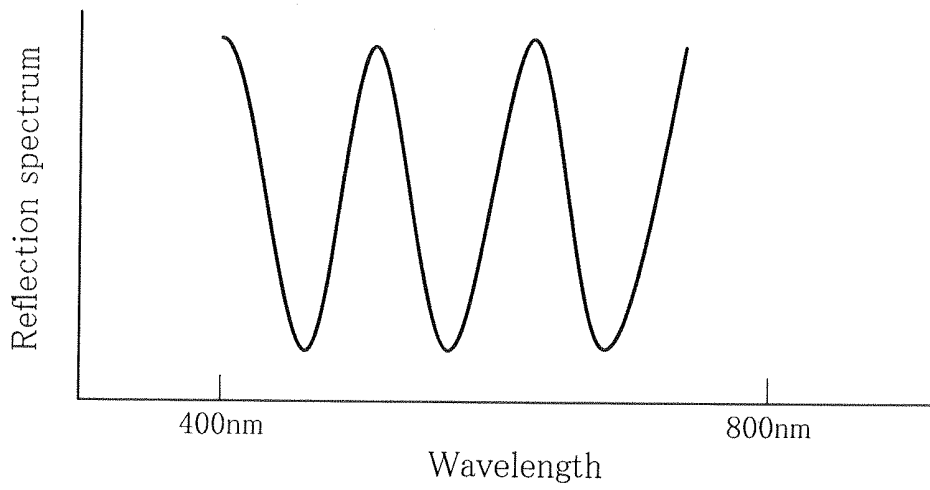

FIG.3(a)

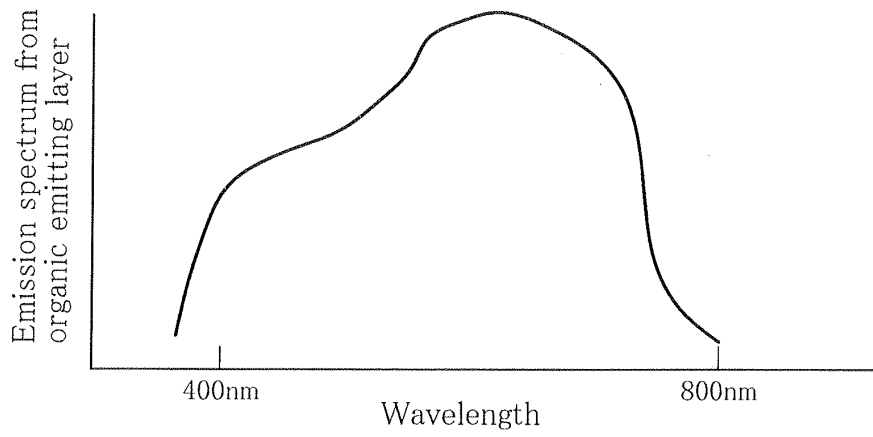

FIG.3(b)

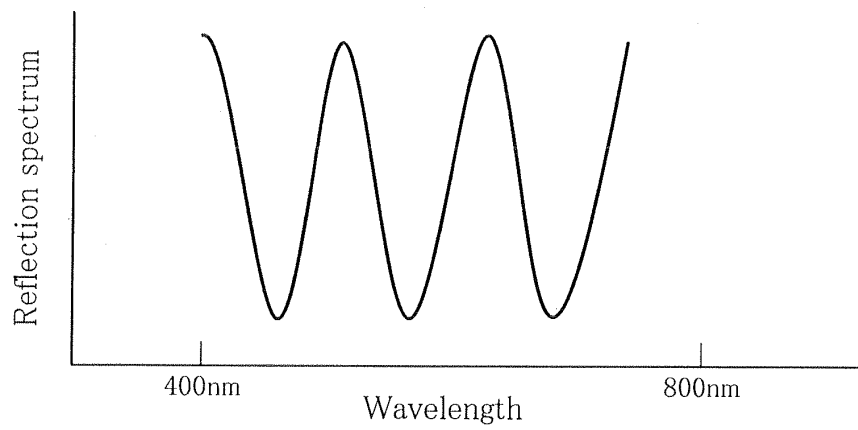

FIG.3(c)

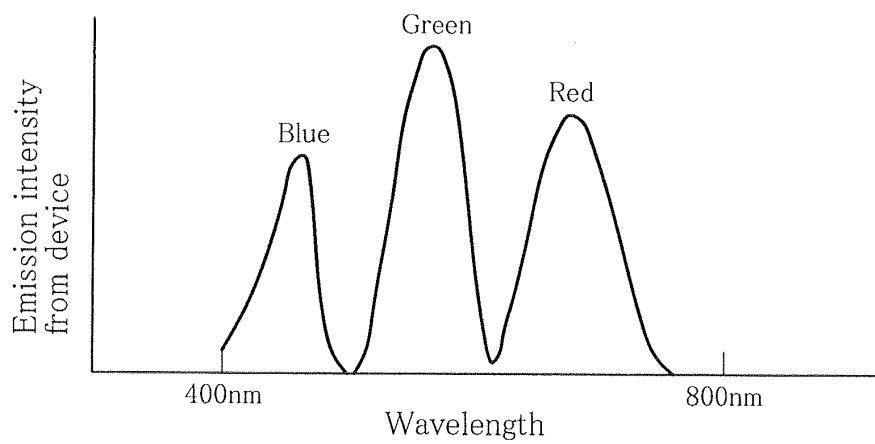

FIG.4(a)

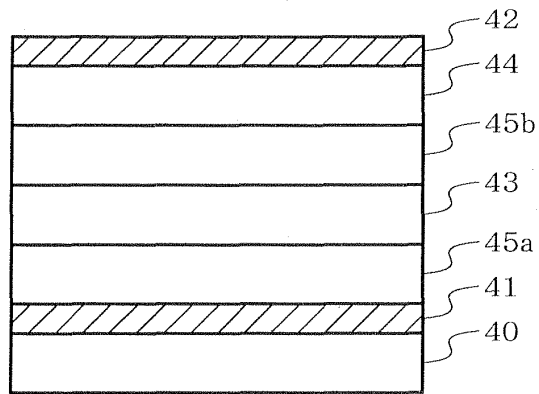

FIG.4(b)

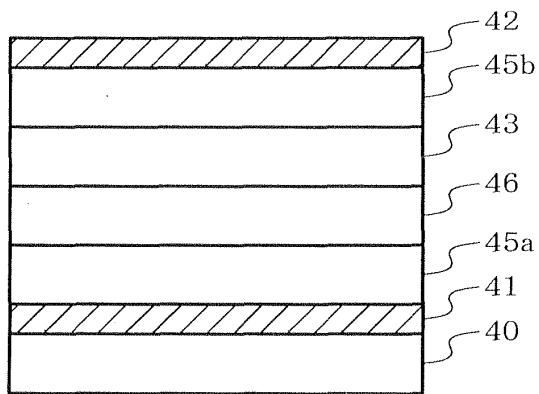

FIG.4(c)

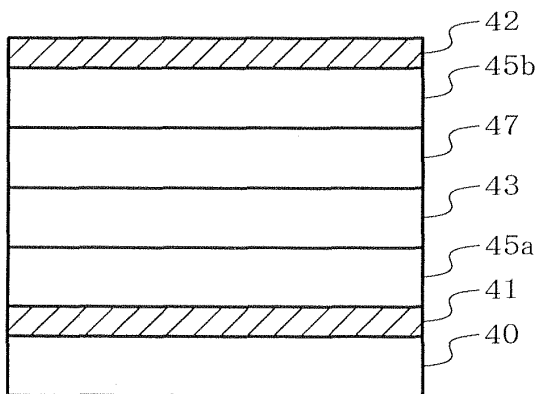

FIG.4(d)

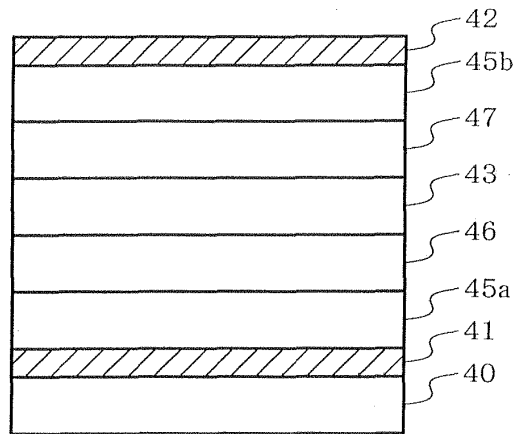

FIG.4(e)

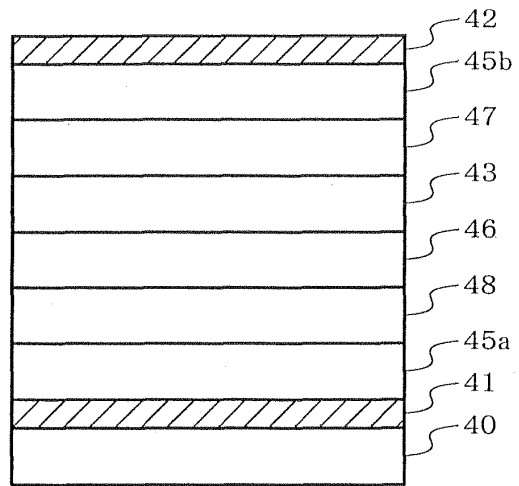

FIG.4(f)

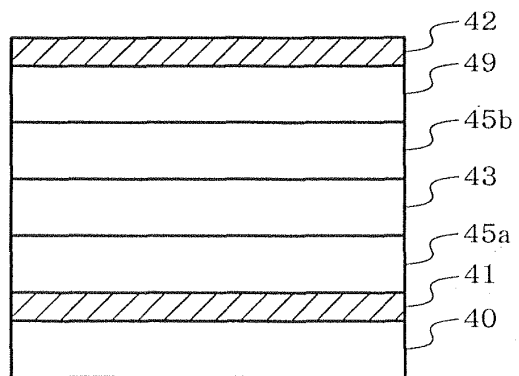

FIG.4 (g)

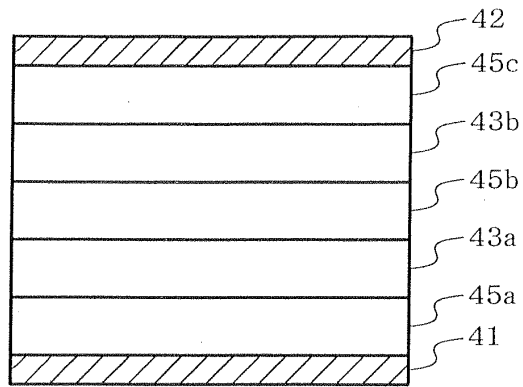

FIG.5

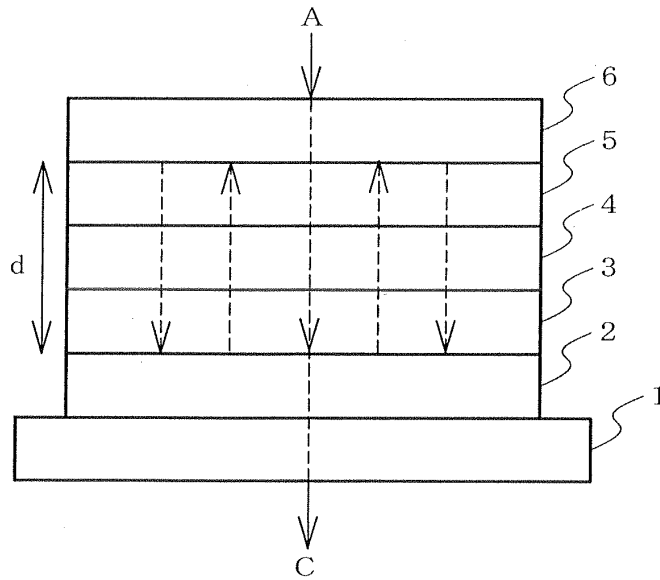

FIG.6

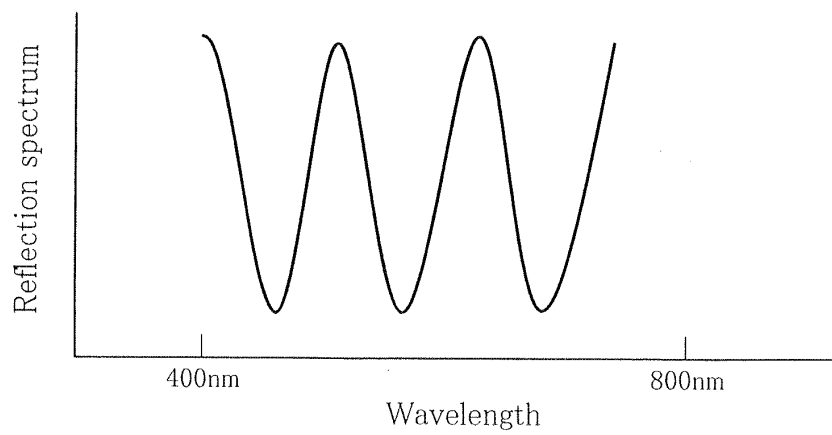

FIG. 7 (a)

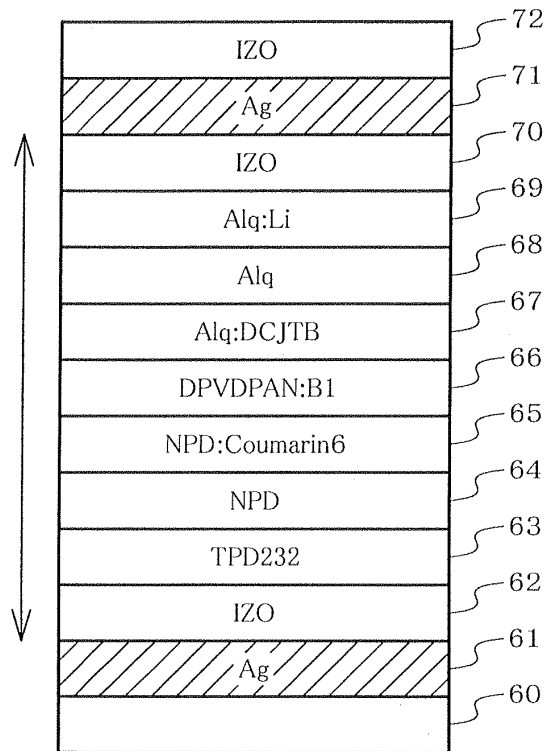

FIG. 7 (b)

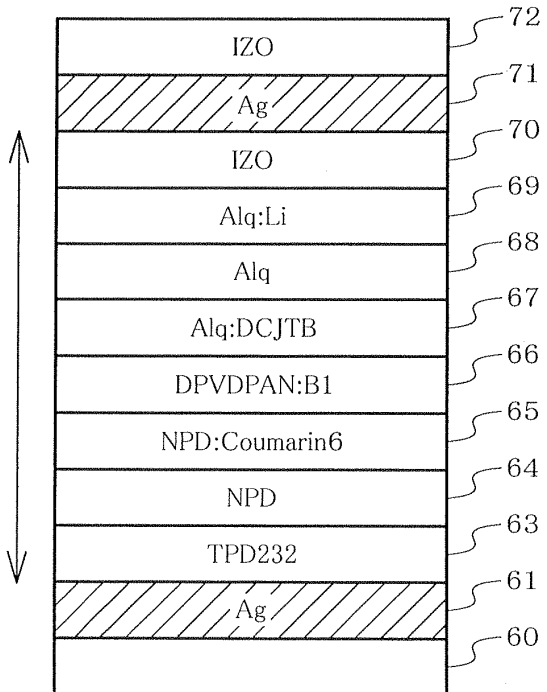

FIG. 7 (c)

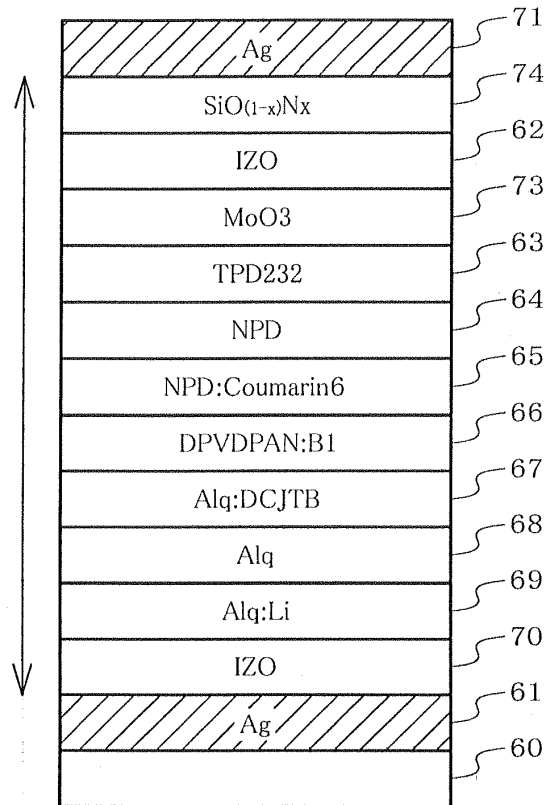
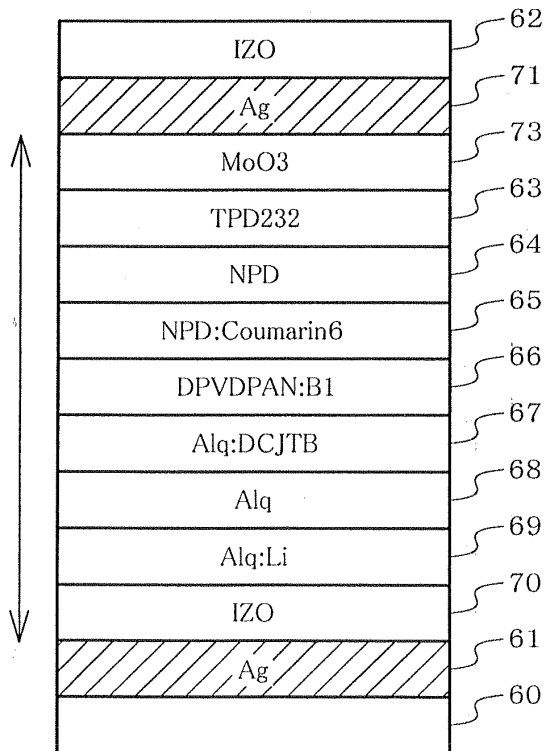

FIG. 7 (d)



INTERNATIONAL SEARCH REPORT

International application No.

PCT/JP2005/003734

A. CLASSIFICATION OF SUBJECT MATTER Int.Cl. ⁷ H05B33/24, H05B33/12, H05B33/14, H05B33/26		
According to International Patent Classification (IPC) or to both national classification and IPC		
B. FIELDS SEARCHED		
Minimum documentation searched (classification system followed by classification symbols) Int.Cl. ⁷ H05B33/24, H05B33/12, H05B33/14, H05B33/26		
Documentation searched other than minimum documentation to the extent that such documents are included in the fields searched Jitsuyo Shinan Koho 1922-1996 Jitsuyo Shinan Toroku Koho 1996-2005 Kokai Jitsuyo Shinan Koho 1971-2005 Toroku Jitsuyo Shinan Koho 1994-2005		
Electronic data base consulted during the international search (name of data base and, where practicable, search terms used)		
C. DOCUMENTS CONSIDERED TO BE RELEVANT		
Category*	Citation of document, with indication, where appropriate, of the relevant passages	Relevant to claim No.
Y	JP 7-320864 A (AT & T Corp.), 08 December, 1995 (08.12.95), Full text; all drawings & EP 683623 A & US 5478658 A & DE 69510863 E	1-8
Y	JP 2003-272855 A (Fuji Electric Co., Ltd.), 26 September, 2003 (26.09.03), Full text; all drawings (Family: none)	1-8
<input type="checkbox"/> Further documents are listed in the continuation of Box C.		<input type="checkbox"/> See patent family annex.
* Special categories of cited documents: "A" document defining the general state of the art which is not considered to be of particular relevance "E" earlier application or patent but published on or after the international filing date "L" document which may throw doubts on priority claim(s) or which is cited to establish the publication date of another citation or other special reason (as specified) "O" document referring to an oral disclosure, use, exhibition or other means "P" document published prior to the international filing date but later than the priority date claimed		"T" later document published after the international filing date or priority date and not in conflict with the application but cited to understand the principle or theory underlying the invention "X" document of particular relevance; the claimed invention cannot be considered novel or cannot be considered to involve an inventive step when the document is taken alone "Y" document of particular relevance; the claimed invention cannot be considered to involve an inventive step when the document is combined with one or more other such documents, such combination being obvious to a person skilled in the art "&" document member of the same patent family
Date of the actual completion of the international search 05 April, 2005 (05.04.05)		Date of mailing of the international search report 19 April, 2005 (19.04.05)
Name and mailing address of the ISA/ Japanese Patent Office		Authorized officer
Facsimile No.		Telephone No.

Form PCT/ISA/210 (second sheet) (January 2004)

REFERENCES CITED IN THE DESCRIPTION

This list of references cited by the applicant is for the reader's convenience only. It does not form part of the European patent document. Even though great care has been taken in compiling the references, errors or omissions cannot be excluded and the EPO disclaims all liability in this regard.

Patent documents cited in the description

- WO 2001039554 A [0007]
- JP H14373776 A [0007]
- JP 57051781 A [0044]
- US 3112197 A [0069]
- US 3189447 A [0069]
- JP 3716096 B [0069]
- US 3615402 A [0069]
- US 3820989 A [0069]
- US 3542544 A [0069]
- JP 45555 B [0069]
- JP 51010983 B [0069]
- JP 51093224 A [0069]
- JP 55017105 A [0069]
- JP 56004148 A [0069]
- JP 55108667 A [0069]
- JP 55156953 A [0069]
- JP 56036656 A [0069]
- US 3180729 A [0069]
- US 4278746 A [0069]
- JP 55088064 A [0069]
- JP 55088065 A [0069]
- JP 49105537 A [0069]
- JP 55051086 A [0069]
- JP 56080051 A [0069]
- JP 56088141 A [0069]
- JP 57045545 A [0069]
- JP 54112637 A [0069]
- JP 55074546 A [0069]
- US 3615404 A [0069]
- JP 51010105 B [0069]
- JP 46003712 B [0069]
- JP 47025336 B [0069]
- JP 54053435 A [0069]
- JP 54110536 A [0069]
- JP 54119925 A [0069]
- US 3567450 A [0069]
- US 3180703 A [0069]
- US 3240597 A [0069]
- US 3658520 A [0069]
- US 4232103 A [0069]
- US 4175961 A [0069]
- US 4012376 A [0069]
- JP 49035702 B [0069]
- JP 3927577 B [0069]
- JP 55144250 A [0069] [0070]
- JP 56119132 A [0069] [0070]
- JP 56022437 A [0069]
- DE 1110518 [0069]
- US 3526501 A [0069]
- US 3257203 A [0069]
- JP 56046234 A [0069]
- JP 54110837 A [0069]
- US 3717462 A [0069]
- JP 54059143 A [0069]
- JP 55052063 A [0069]
- JP 55052064 A [0069]
- JP 55046760 A [0069]
- JP 55085495 A [0069]
- JP 57011350 A [0069]
- JP 57148749 A [0069]
- JP 2311591 A [0069]
- JP 61210363 A [0069]
- JP 61228451 A [0069]
- JP 61014642 A [0069]
- JP 61072255 A [0069]
- JP 62047646 A [0069]
- JP 62036674 A [0069]
- JP 62010652 A [0069]
- JP 62030255 A [0069]
- JP 60093455 A [0069]
- JP 60094462 A [0069]
- JP 60174749 A [0069]
- JP 60175052 A [0069]
- US 4950950 A [0069]
- JP 2204996 A [0069]
- JP 2282263 A [0069]
- JP 1211399 A [0069]
- JP 632956965 A [0070]
- US 4127412 A [0070]
- JP 53027033 A [0070]
- JP 54058445 A [0070]
- JP 54149634 A [0070]
- JP 54064299 A [0070]
- JP 55079450 A [0070]
- JP 61295558 A [0070]
- JP 61098353 A [0070]
- JP 63295695 A [0070]
- US 5061569 A [0070]
- JP 4308688 A [0070]
- JP 8193191 A [0073]
- JP 2003005184 A [0082]
- JP 2003004193 A [0083]
- JP 9087616 A [0084]
- JP 9194487 A [0085]
- JP 2000040586 A [0086]
- JP 10088121 A [0087]

专利名称(译)	有机电致发光元件和显示器		
公开(公告)号	EP1722606A1	公开(公告)日	2006-11-15
申请号	EP2005720006	申请日	2005-03-04
[标]申请(专利权)人(译)	出光兴产株式会社		
申请(专利权)人(译)	出光兴产股份有限公司.		
当前申请(专利权)人(译)	出光兴产股份有限公司.		
[标]发明人	FUKUOKA KENICHI YUASA KIMIHIRO HOSOKAWA CHISHIO		
发明人	FUKUOKA, KENICHI YUASA, KIMIHIRO HOSOKAWA, CHISHIO		
IPC分类号	H05B33/24 H05B33/12 H05B33/14 H05B33/26		
CPC分类号	H01L51/5265 H01L51/5036		
代理机构(译)	GILLE HRABAL STRUCK NEIDLEIN PROP ROOS		
优先权	2004062773 2004-03-05 JP		
其他公开文献	EP1722606A4		
外部链接	Espacenet		

摘要(译)

一种有机电致发光器件，包括至少第一光反射层（2），第一透明电极（3），有机发光层（4），第二透明电极（5）和堆叠在其上的第二光反射层（6）基板（1）的顺序；其中第一光反射层（2）和第二光反射层（6）中的至少一个是半透光的。施加的光（A）在第一和第二光反射层（2），（6）之间反射并经历光学干涉效应，并且反射光（B）通过第二光反射层（6）发射到外部。透光。此时，通过调节光反射层（2）和（6）之间的光程长度，允许反射光（B）的光谱具有特定值的尖峰。结果，改善了色纯度。

FIG. 1

