

(19)



(11)

EP 2 675 867 B1

(12)

EUROPEAN PATENT SPECIFICATION

(45) Date of publication and mention of the grant of the patent:
09.05.2018 Bulletin 2018/19

(51) Int Cl.:
C09K 11/06 (2006.01) H01L 51/54 (2006.01)

(21) Application number: **11868334.1**

(86) International application number:
PCT/KR2011/007182

(22) Date of filing: **29.09.2011**

(87) International publication number:
WO 2012/176959 (27.12.2012 Gazette 2012/52)

(54) **MATERIAL FOR ORGANIC OPTOELECTRONIC DEVICE, ORGANIC LIGHT EMITTING DIODE INCLUDING THE SAME AND DISPLAY INCLUDING THE ORGANIC LIGHT EMITTING DIODE**

MATERIAL FÜR EINE ORGANISCHE OPTOELEKTRONISCHE VORRICHTUNG, ORGANISCHE LICHEMITTIERENDE DIODE DAMIT UND ANZEIGE MIT DER ORGANISCHEN LICHEMITTIERENDEN DIODE

MATÉRIAU POUR DISPOSITIF OPTOÉLECTRONIQUE ORGANIQUE, DIODE ÉLECTROLUMINESCENTE ORGANIQUE COMPRENANT CELUI-CI ET DISPOSITIF D’AFFICHAGE COMPRENANT LA DIODE ÉLECTROLUMINESCENTE ORGANIQUE

(84) Designated Contracting States:
AL AT BE BG CH CY CZ DE DK EE ES FI FR GB GR HR HU IE IS IT LI LT LU LV MC MK MT NL NO PL PT RO RS SE SI SK SM TR

- **LEE, Nam-Heon**
Uiwang-si
Gyeonggi-do 437-711 (KR)
- **CHAE, Mi-Young**
Uiwang-si
Gyeonggi-do 437-711 (KR)

(30) Priority: **20.06.2011 KR 20110059835**

(43) Date of publication of application:
25.12.2013 Bulletin 2013/52

(74) Representative: **Michalski Hüttermann & Partner**
Patentanwälte mbB
Speditionstraße 21
40221 Düsseldorf (DE)

(73) Proprietor: **Cheil Industries Inc.**
Kumi-city, Kyungsangbuk-do 730-030 (KR)

(72) Inventors:
• **YU, Eun-Sun**
Uiwang-si
Gyeonggi-do 437-711 (KR)
• **KANG, Eui-Su**
Uiwang-si
Gyeonggi-do 437-711 (KR)

(56) References cited:
EP-A2- 2 568 030 **WO-A1-2011/024451**
WO-A1-2012/023947 **WO-A1-2012/087007**
WO-A1-2012/108881 **WO-A1-2012/121561**
WO-A1-2012/141499 **WO-A1-2012/161382**
WO-A2-2011/055934 **JP-A- 8 003 547**
JP-A- 2003 133 075 **KR-A- 20110 015 836**

EP 2 675 867 B1

Note: Within nine months of the publication of the mention of the grant of the European patent in the European Patent Bulletin, any person may give notice to the European Patent Office of opposition to that patent, in accordance with the Implementing Regulations. Notice of opposition shall not be deemed to have been filed until the opposition fee has been paid. (Art. 99(1) European Patent Convention).

Description**BACKGROUND OF THE INVENTION**5 **(a) Field of the Invention**

[0001] A material for an organic optoelectronic device that is capable of providing an organic optoelectronic device having excellent life-span, efficiency, electrochemical stability, and thermal stability, an organic light emitting diode and a display device including the organic light emitting diode are related.

10

(b) Description of the Related Art

[0002] An organic optoelectric device is a device requiring a charge exchange between an electrode and an organic material by using a hole or an electron.

15 [0003] An organic optoelectric device may be classified as follows in accordance with its driving principles. A first organic optoelectric device is an electron device driven as follows: excitons are generated in an organic material layer by photons from an external light source; the excitons are separated into electrons and holes; and the electrons and holes are transferred to different electrodes as a current source (voltage source).

20 [0004] A second organic optoelectric device is an electron device driven as follows: a voltage or a current is applied to at least two electrodes to inject holes and/or electrons into an organic material semiconductor positioned at an interface of the electrodes; and the device is driven by the injected electrons and holes.

25 [0005] As examples, the organic optoelectric device includes a photoelectric device, an organic light emitting diode (OLED), an organic solar cell, an organic photo-conductor drum, an organic transistor, an organic memory device, etc., and it requires a hole injecting or transporting material, an electron injecting or transporting material, or a light emitting material.

[0006] Particularly, the organic light emitting diode (OLED) has recently drawn attention due to an increase in demand for flat panel displays. In general, organic light emission refers to transformation of electrical energy to photo-energy.

30 [0007] The organic light emitting diode transforms electrical energy into light by applying current to an organic light emitting material. It has a structure in which a functional organic material layer is interposed between an anode and a cathode. The organic material layer includes a multi-layer including different materials, for example a hole injection layer (HIL), a hole transport layer (HTL), an emission layer, an electron transport layer (ETL), and an electron injection layer (EIL), in order to improve efficiency and stability of an organic light emitting diode.

35 [0008] In such an organic light emitting diode, when a voltage is applied between an anode and a cathode, holes from the anode and electrons from the cathode are injected to an organic material layer. The generated excitons generate light having certain wavelengths while shifting to a ground state.

[0009] Recently, it has become known that a phosphorescent light emitting material can be used for a light emitting material of an organic light emitting diode in addition to the fluorescent light emitting material. Such a phosphorescent material emits lights by transiting the electrons from a ground state to an excited state, non-radiance transiting of a singlet exciton to a triplet exciton through intersystem crossing, and transiting a triplet exciton to a ground state to emit light.

40 [0010] As described above, in an organic light emitting diode, an organic material layer includes a light emitting material and a charge transport material, for example a hole injection material, a hole transport material, an electron transport material, an electron injection material, and so on.

[0011] The light emitting material is classified as blue, green, and red light emitting materials according to emitted colors, and yellow and orange light emitting materials to emit colors approaching natural colors.

45 [0012] When one material is used as a light emitting material, a maximum light emitting wavelength is shifted to a long wavelength or color purity decreases because of interactions between molecules, or device efficiency decreases because of a light emitting quenching effect. Therefore, a host/dopant system is included as a light emitting material in order to improve color purity and increase luminous efficiency and stability through energy transfer.

50 [0013] In order to implement excellent performance of an organic light emitting diode, a material constituting an organic material layer, for example a hole injection material, a hole transport material, a light emitting material, an electron transport material, an electron injection material, and a light emitting material such as a host and/or a dopant, should be stable and have good efficiency. However, development of an organic material layer forming material for an organic light emitting diode has thus far not been satisfactory and thus there is a need for a novel material. This material development is also required for other organic optoelectric devices.

55 [0014] The low molecular organic light emitting diode is manufactured as a thin film in a vacuum deposition method and can have good efficiency and life-span performance. A polymer organic light emitting diode is manufactured in an Inkjet or spin coating method has an advantage of low initial cost and being large-sized.

[0015] Both low molecular organic light emitting and polymer organic light emitting diodes have an advantage of self-

light emitting, high speed response, wide viewing angle, ultrathin, high image quality, durability, large driving temperature range, and the like. In particular, they have good visibility due to self-light emitting characteristic compared with a conventional LCD (liquid crystal display) and have an advantage of decreasing thickness and weight of LCD up to a third, because they do not need a backlight.

[0016] In addition, since they have a response speed 1000 time faster microsecond unit than LCD, they can realize a perfect motion picture without after-image. Based on these advantages, they have been remarkably developed to have 80 times efficiency and more than 100 times life-span since they come out for the first time in the late 1980s. Recently, they keep being rapidly larger such as a 40-inch organic light emitting diode panel.

[0017] They are simultaneously required to have improved luminous efficiency and life-span in order to be larger. Herein, their luminous efficiency need smooth combination between holes and electrons in an emission layer. However, since an organic material in general has slower electron mobility than hole mobility, it has a drawback of inefficient combination between holes and electrons. Accordingly, while increasing electron injection and mobility from a cathode and simultaneously preventing movement of holes is required.

[0018] In order to improve life-span, a material crystallization caused by Joule heats generated during device operating is required to be prevented. Accordingly, there has been a strong need for an organic material having excellent electron injection and mobility, and high electrochemical stability.

[0019] Materials for organic optoelectronic devices are inter alia described in the KR 10-2011-0015836, WO 2011/055934, WO 2011/024451, JP 2003/133075 and JP08/003547.

SUMMARY OF THE INVENTION

[0020] A material for an organic optoelectronic device that may act as a hole injection and hole transport, or an electron injection and transport, and also act as a light emitting host along with an appropriate dopant is provided.

[0021] A light emitting diode having excellent life span, efficiency, a driving voltage, electrochemical stability, and thermal stability and a display device including the same are provided.

[0022] According to one embodiment of the present invention, an organic material for an organic optoelectronic device including at least one compound represented by the following Chemical Formula A-1; and at least one compound represented by the following Chemical Formula B-1 is provided.

[Chemical Formula A-1]

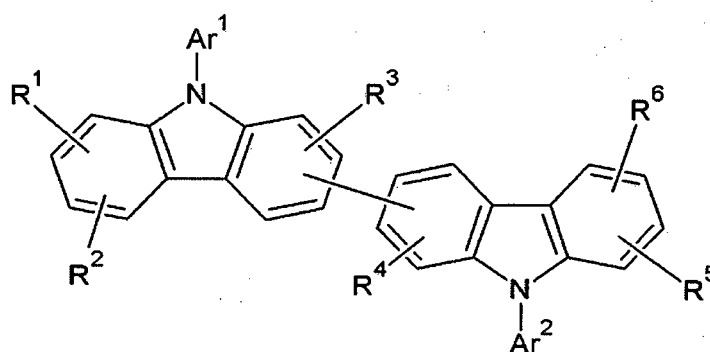

[0023] In Chemical Formula A-1, Ar¹ is a substituted or unsubstituted pyridinyl group, Ar² is hydrogen, deuterium, a C1 to C30 alkyl group, a C6 to C30 aryl group, or a substituted or unsubstituted pyrimidyl group, and R¹ to R⁶ are the same or different and independently hydrogen, deuterium, a C1 to C30 alkyl group, a C6 to C30 aryl group, or a combination thereof,

[Chemical Formula B-1]

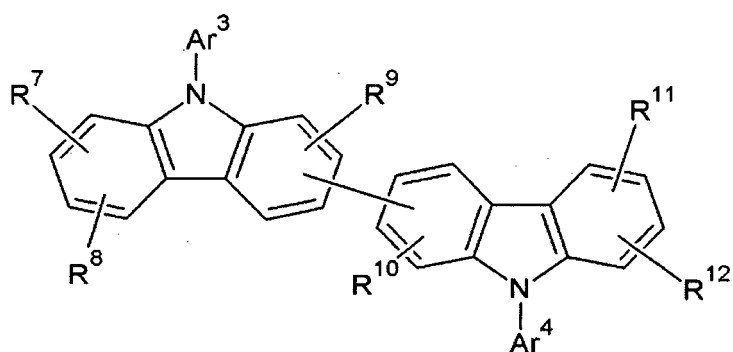

[0024] In Chemical Formula B-1, Ar³ is a substituted or unsubstituted heteroaryl group including at least two nitrogen, Ar⁴ is hydrogen, deuterium, a C1 to C30 alkyl group, C6 to C30 aryl group, or a substituted or unsubstituted heteroaryl group including at least two nitrogen, and R⁷ to R¹² are the same or different and independently hydrogen, deuterium, a C1 to C30 alkyl group, a C6 to C30 aryl group, or a combination thereof.

[0025] The at least one compound represented by the following Chemical Formula A-1 may be represented by the following Chemical Formula A-2, and the at least one compound represented by the following Chemical Formula B-1 may be represented by the following Chemical Formula B-2.

[Chemical Formula A-2]

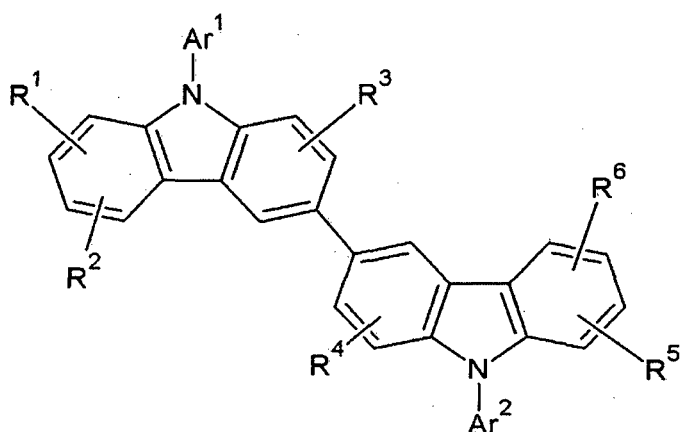

[0026] In Chemical Formula A-2, Ar¹ is a substituted or unsubstituted pyridinyl group, Ar² is hydrogen, deuterium, a C1 to C30 alkyl group, a C6 to C30 aryl group, or a substituted or unsubstituted pyrimidyl group, and R¹ to R⁶ are the same or different and independently hydrogen, deuterium, a C1 to C30 alkyl group, a C6 to C30 aryl group, or a combination thereof,

[Chemical Formula B-2]

5

10

15

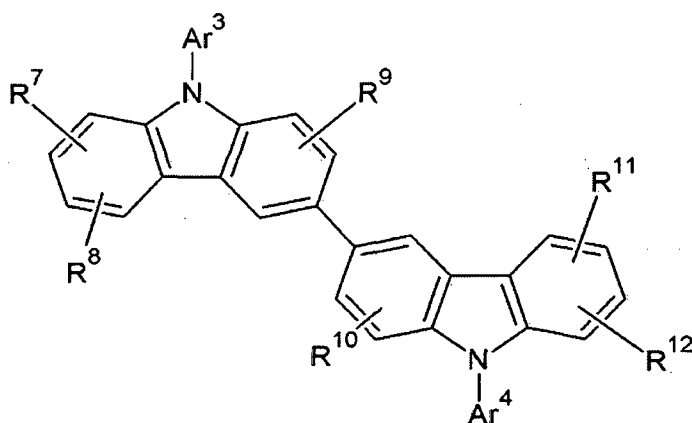

20

[0027] In Chemical Formula B-2, Ar³ is a substituted or unsubstituted heteroaryl group including at least two nitrogen, Ar⁴ is hydrogen, deuterium, a C1 to C30 alkyl group, C6 to C30 aryl group, or a substituted or unsubstituted heteroaryl group including at least two nitrogen, and R⁷ to R¹² are the same or different and independently hydrogen, deuterium, a C1 to C30 alkyl group, a C6 to C30 aryl group, or a combination thereof.

[0028] The Ar³ may be represented by the Chemical Formula selected from the group consisting of the following Chemical Formulas B-3, B-4, B-5, and B-6.

25

[Chemical Formula B-3] [Chemical Formula B-4]

30

35

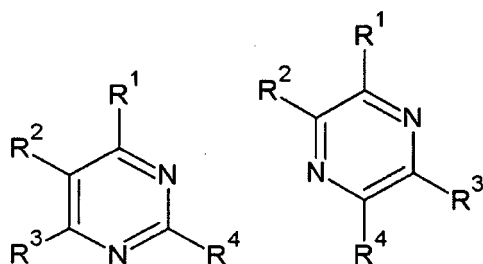

40

[Chemical Formula B-5] [Chemical Formula B-6]

45

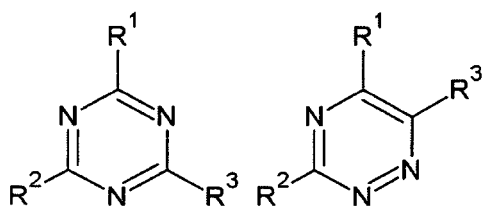

50

[0029] In Chemical Formulas B-3, B-4, B-5 and B-6, R¹ to R⁴ are the same or different and independently hydrogen, deuterium, a C1 to C30 alkyl group, a C6 to C30 aryl group, or a combination thereof, in Chemical Formulas B-3 and B-4, one of R¹ to R⁴ is a single bond linked to nitrogen of the above Chemical Formula B-1, and in Chemical Formulas B-5 and B-6, and one of R¹ to R³ is a single bond linked to nitrogen of the above Chemical Formula B-1.

[0030] The Ar² and Ar⁴ may be the same or different and independently

[0031] The Ar¹ may be represented by the following Chemical Formula A-3 or Chemical Formula A-4.

55

[Chemical Formula A-3] [Chemical Formula A-4]

5

10

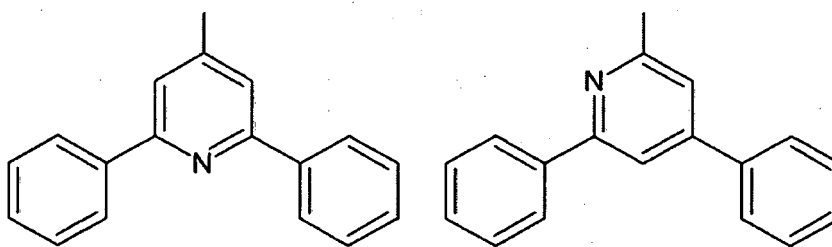

[0032] The Ar³ of the above Chemical Formula B-1 may be a substituted or unsubstituted triazinyl group.

[0033] The Ar³ of the above Chemical Formula B-1 may be a substituted or unsubstituted pyrimidinyl group.

[0034] The compound represented by the above Chemical Formula A-1 may be represented by one of the following Chemical Formulas A-101 to A-118.

15

[Chemical Formula A-101] [Chemical Formula A-102] [Chemical Formula

A-103]

20

25

30

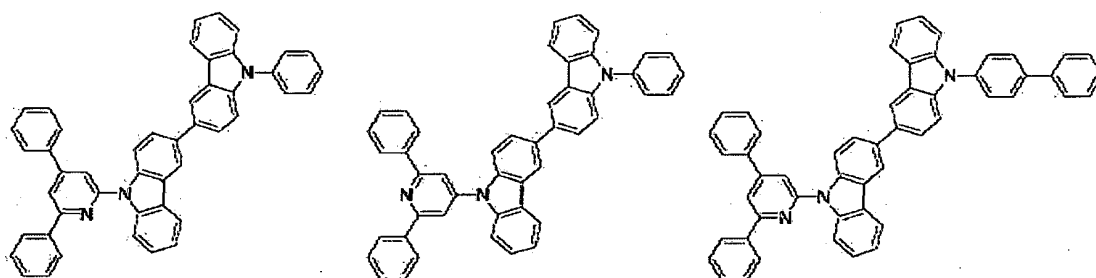

[Chemical Formula A-104] [Chemical Formula A-105] [Chemical Formula

A-106]

35

40

45

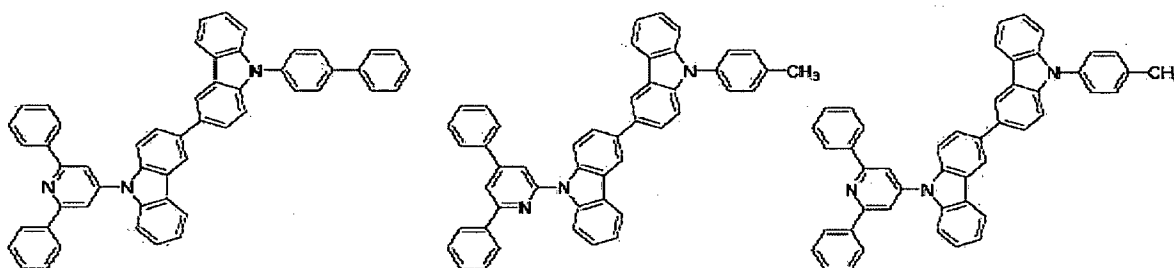

50

55

[Chemical Formula A-107] [Chemical Formula A-108] [Chemical Formula

A-109]

5

10

15

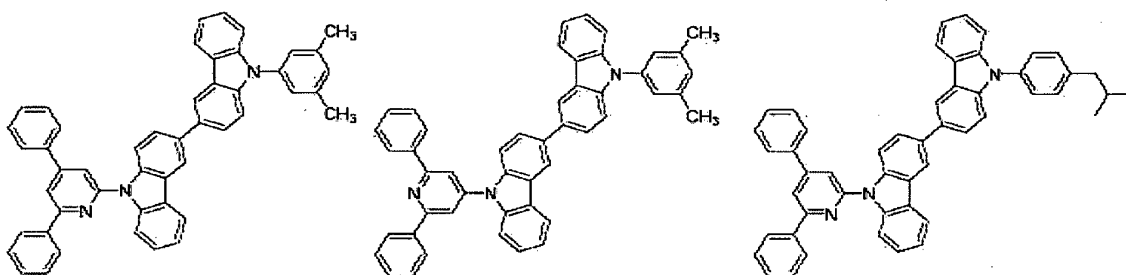

[Chemical Formula A-110] [Chemical Formula A-111] [Chemical Formula

A-112]

20

25

30

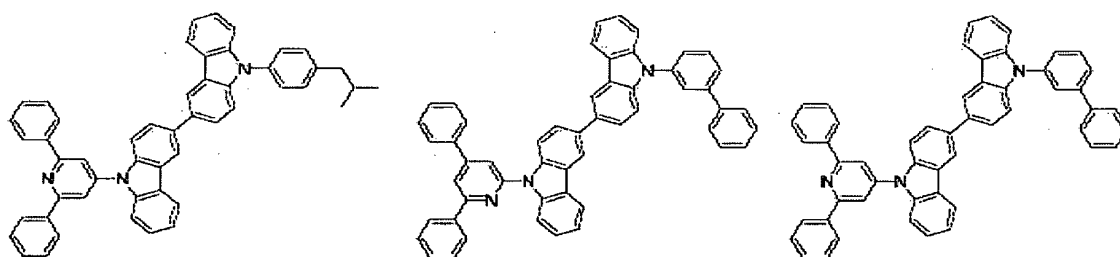

[Chemical Formula A-113] [Chemical Formula A-114] [Chemical Formula

A-115]

35

40

45

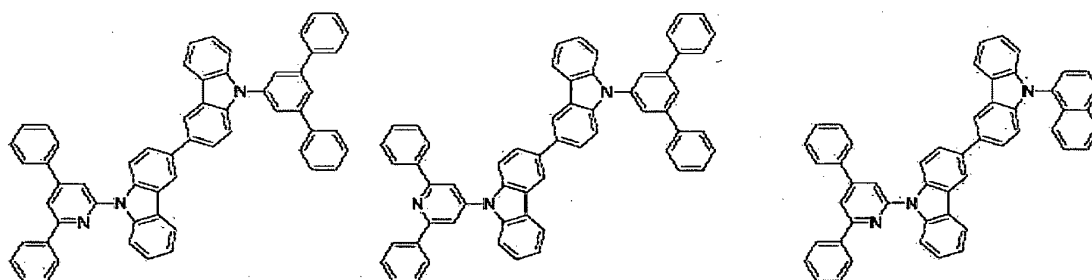

[Chemical Formula A-116] [Chemical Formula A-117] [Chemical Formula

A-118]

50

55

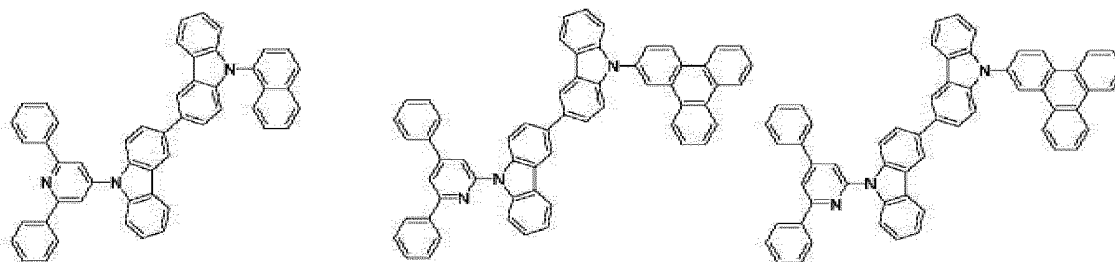

5

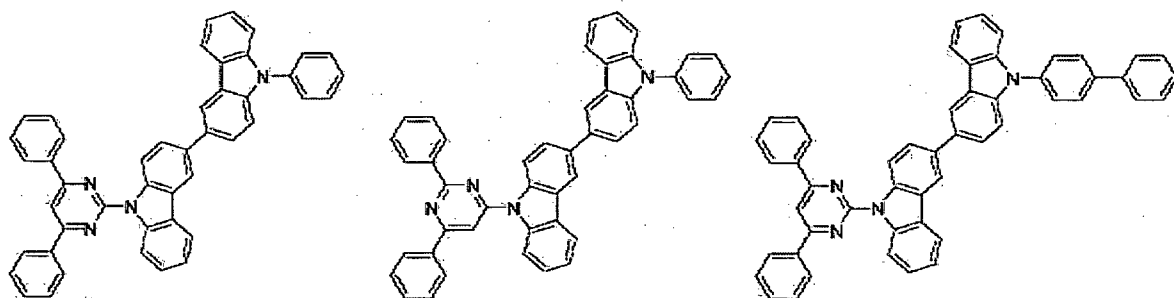

10

15

[Chemical Formula B-204] [Chemical Formula B-205] [Chemical Formula B-206]

20

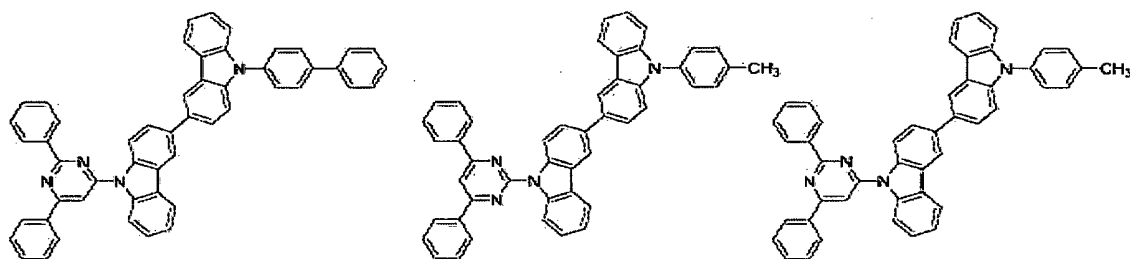

25

30

[Chemical Formula B-207] [Chemical Formula B-208] [Chemical Formula B-209]

35

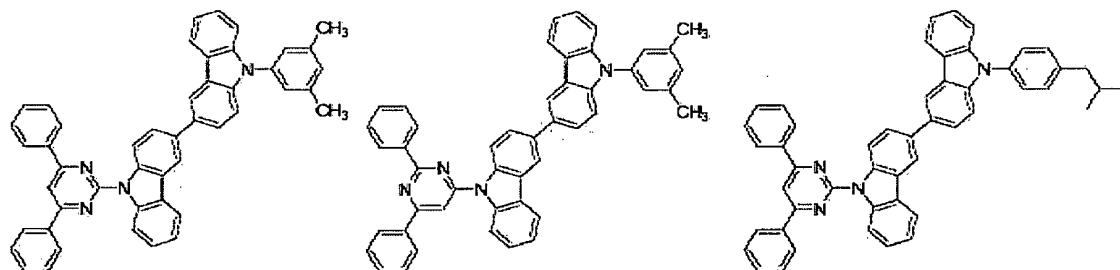

40

45

[Chemical Formula B-210] [Chemical Formula B-211] [Chemical Formula B-212]

50

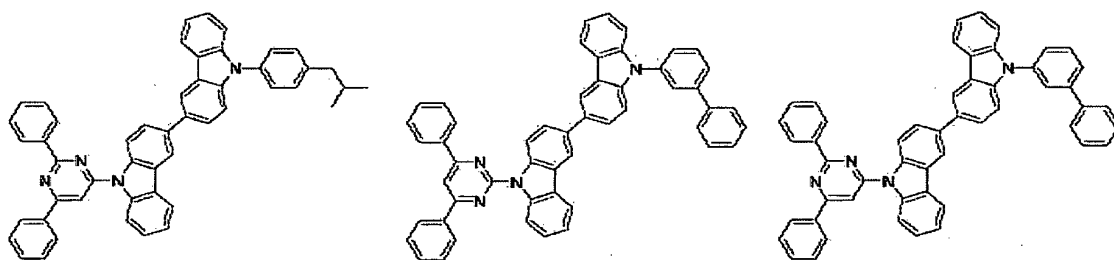

55

[Chemical Formula B-213] [Chemical Formula B-214] [Chemical Formula

B-215]

5

10

15

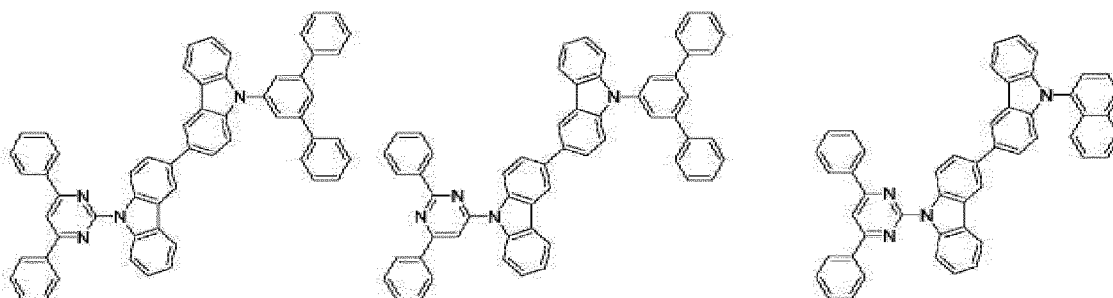

[Chemical Formula B-216] [Chemical Formula B-217] [Chemical Formula

B-218]

20

25

30

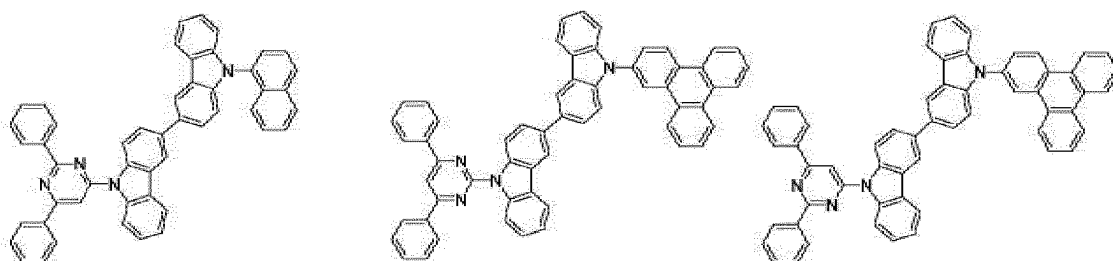

[0037] The compound represented by the above Chemical Formula B-1 may have a LUMO energy level that is lower by 0.2eV or more than a LUMO energy level of the compound represented by the above Chemical Formula A-1.

[0038] The organic optoelectronic device may be selected from an organic photoelectric device, an organic light emitting diode, an organic solar cell, an organic transistor, an organic photo-conductor drum, and an organic memory device.

[0039] According to another embodiment of the present invention, provided is an organic light emitting diode that includes an anode, a cathode, and at least one or more organic thin layer between the anode and the cathode, wherein at least one of the organic thin layer includes the material for an organic optoelectronic device.

[0040] The organic thin layer may include an emission layer, a hole transport layer (HTL), a hole injection layer (HIL), an electron transport layer (ETL), an electron injection layer (EIL), a hole blocking layer, or a combination thereof.

[0041] The material for an organic optoelectronic device may be included in a hole transport layer (HTL) or a hole injection layer (HIL).

[0042] The material for an organic optoelectronic device may be included in an emission layer.

[0043] The material for an organic optoelectronic device may be used as a phosphorescent or fluorescent host material in an emission layer.

[0044] According to another embodiment of the present invention, a display device including the organic light emitting diode is provided.

[0045] The compound for an organic optoelectronic device has an excellent hole or electron transporting property, high film stability, thermal stability, and triplet excitation energy.

[0046] The material may be used as a hole injection/ transport material of an emission layer, a host material, or an electron injection/ transport material. The organic optoelectronic device has an excellent electrochemical and thermal stability, and therefore, may provide an organic light emitting diode having an excellent life-span characteristic, and high luminous efficiency at a low driving voltage.

BRIEF DESCRIPTION OF THE DRAWINGS

[0047]

FIGS. 1 to 5 are cross-sectional views showing organic light emitting diodes including compounds according to various embodiments of the present invention.

FIG. 6 provides data evaluating life-span characteristic of the organic light emitting diodes according to Examples 1 to 4 and Comparative Examples 1 to 5.

FIG. 7 provides data evaluating life-span characteristic of the organic light emitting diodes according to Example 5 and Comparative Example 6.

FIG. 8 shows the liquid chromatography result of 100% of the compound A-101.

FIG. 9 shows the liquid chromatography result of 99.98% of the compound B-103.

FIG. 10 shows the liquid chromatography result of the materials used in an emission layer for an organic light emitting diode according to Example 1.

DETAILED DESCRIPTION

[0048] Exemplary embodiments of the present invention will hereinafter be described in detail. However, these embodiments are only exemplary, and the present invention is not limited thereto but rather is defined by the scope of the appended claims.

[0049] As used herein, when specific definition is not otherwise provided, the term "substituted" refers to one substituted with deuterium, a halogen, a hydroxy group, an amino group, a substituted or unsubstituted C1 to C20 amine group, a nitro group, a substituted or unsubstituted C3 to C40 silyl group, a C1 to C30 alkyl group, a C1 to C10 alkylsilyl group, a C3 to C30 cyclo alkyl group, a C6 to C30 aryl group, a C1 to C20 alkoxy group, a fluoro group, a C1 to C10 trifluoro alkyl group such as a trifluoromethyl group, or a cyano group, instead of hydrogen.

[0050] Two adjacent substituents of the substituted a hydroxy group, amino group, a substituted or unsubstituted C1 to C20 amine group, nitro group, a substituted or unsubstituted C3 to C40 silyl group, a C1 to C30 alkyl group, a C1 to C10 alkylsilyl group, C3 to C30 cycloalkyl group, a C6 to C30 aryl group, C1 to C20 alkoxy group, a C1 to C10 trifluoroalkyl group such as a trifluoromethyl group, or a cyano group are linked to each other to provide a fused ring.

[0051] As used herein, when specific definition is not otherwise provided, the term "hetero" refers to one including 1 to 3 of N, O, S, or P, and remaining carbons in one ring.

[0052] As used herein, when a definition is not otherwise provided, the term "combination thereof" refers to at least two substituents bound to each other by a linker, or at least two substituents condensed to each other.

[0053] As used herein, when a definition is not otherwise provided, the term "alkyl group" refers to an aliphatic hydrocarbon group. The alkyl may be a saturated alkyl group that does not include any double bond or triple bond.

[0054] Alternatively, the alkyl may be an unsaturated alkyl group that includes at least one double bond or triple bond.

[0055] The term "alkenylene group" may refer to a group in which at least two carbon atoms are bound in at least one carbon-carbon double bond, and the term "alkynylene group" may refer to a group in which at least two carbon atoms are bound in at least one carbon-carbon triple bond. Regardless of being saturated or unsaturated, the alkyl may be branched, linear, or cyclic.

[0056] The alkyl group may be a C1 to C20 alkyl group. More particularly, the alkyl group may be a C1 to C10 alkyl group or a C1 to C6 alkyl group.

[0057] For example, a C1 to C4 alkyl group may have 1 to 4 carbon atoms and may be selected from the group consisting of methyl, ethyl, propyl, iso-propyl, n-butyl, iso-butyl, sec-butyl, and t-butyl.

[0058] Examples of the alkyl group may be a methyl group, an ethyl group, a propyl group, an isopropyl group, a butyl group, an isobutyl group, a t-butyl group, a pentyl group, a hexyl group, an ethenyl group, a propenyl group, a butenyl group, a cyclopropyl group, a cyclobutyl group, a cyclopentyl group, a cyclohexyl group, and the like.

[0059] The term "aromatic group" may refer to a cyclic functional group where all elements have conjugated p-orbital. Examples of the aromatic group include an aryl group and a heteroaryl group.

[0060] The term "aryl group" may refer to an aryl group including a carbocyclic aryl (e.g., phenyl) having at least one ring having a covalent pi electron system.

[0061] The term "heteroaryl group" may refer to an aryl group where 1 to 3 heteroatoms selected from N, O, S, and P, and remaining carbon. When the heteroaryl group is a fused ring, each ring may include 1 to 3 heteroatoms.

[0062] As used herein, hole properties refer to that holes generated at an anode are easily injected into an emission layer and moved therein due to conduction properties according to HOMO levels.

[0063] Electron properties refer to that electrons generated at a cathode are easily injected into an emission layer and moved therein due to conduction properties according to LUMO levels.

[0064] According to one embodiment of the present invention, a material for an organic optoelectronic device may include more than two different compounds having a bicarbazolyl group as a core.

[0065] Accordingly, the organic optoelectronic device may have both of the characteristics of the two compounds.

[0066] For example, an emission layer for an organic optoelectronic device delivers both holes and electrons and thus, requires an amphiphilic material having excellent hole and electron properties. However, an organic low molecular

compound with amphiphilic properties is hard to develop. In general, an organic low molecular compound tends to have either of electron properties or hole properties.

[0067] Accordingly, one embodiment of the present invention may provide a material for an organic optoelectronic device by mixing more than two compounds to satisfy amphiphilic properties.

[0068] According to one embodiment of the present invention, an organic material for an organic optoelectronic device includes at least one compound represented by the following Chemical Formula A-1; and at least one compound represented by the following Chemical Formula B-1.

[Chemical Formula A-1]

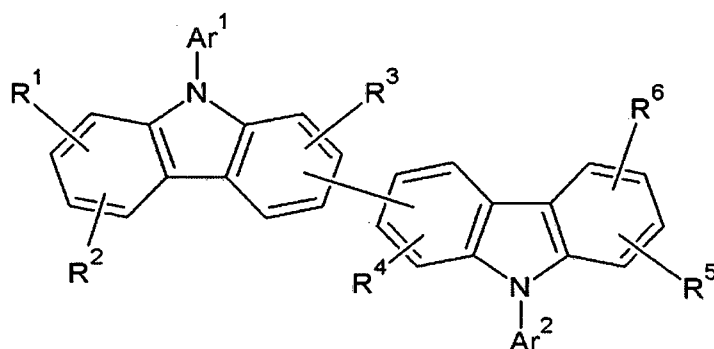

[0069] In Chemical Formula A-1, Ar¹ is a substituted or unsubstituted pyridinyl group, Ar² is hydrogen, deuterium, a C1 to C30 alkyl group, a C6 to C30 aryl group, or a substituted or unsubstituted pyrimidyl group, and R¹ to R⁶ are the same or different and independently hydrogen, deuterium, a C1 to C30 alkyl group, a C6 to C30 aryl group, or a combination thereof,

[Chemical Formula B-1]

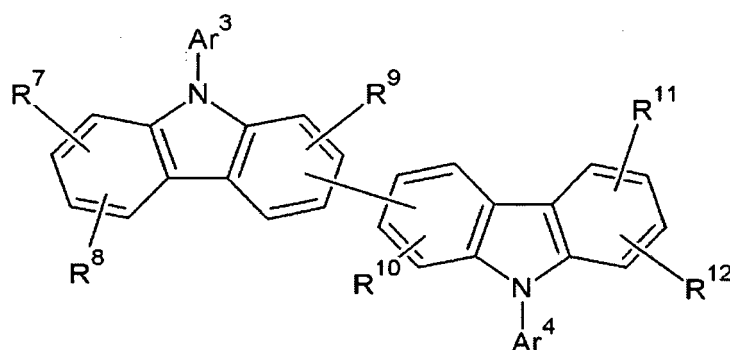

[0070] In Chemical Formula B-1, Ar³ is a substituted or unsubstituted heteroaryl group including at least two nitrogen, Ar⁴ is hydrogen, deuterium, a C1 to C30 alkyl group, C6 to C30 aryl group, or a substituted or unsubstituted heteroaryl group including at least two nitrogen, and R⁷ to R¹² are the same or different and independently hydrogen, deuterium, a C1 to C30 alkyl group, a C6 to C30 aryl group, or a combination thereof.

[0071] The compound represented by the above Chemical Formula A-1 is a bicarbazole-based compound substituted with a pyridinyl group and having relatively excellent properties.

[0072] The compound represented by the above Chemical Formula B-1 may have a LUMO energy level that is lower by 0.2eV or more than a LUMO energy level of the compound represented by the above Chemical Formula A-1. More specifically, the compound represented by the above Chemical Formula B-1 may have a LUMO energy level that is lower by 0.3eV or more than a LUMO energy level of the compound represented by the above Chemical Formula A-1.

[0073] The compound including a pyridinyl group represented by the above Chemical Formula A-1 has relatively higher LUMO energy level than that of an electron transport layer (ETL) material and may improve a driving voltage of a device.

[0074] Accordingly, the compound is mixed with a material with a low LUMO energy level and may overcome the

problem. Herein, the material may have the same LUMO energy level as or a little higher LUMO energy level than an electron transport layer (ETL) material. The material may be a compound including a pyrimidinyl group or a triazinyl group represented by the above Chemical Formula B-1.

[0075] The compound has a core moiety and another substituent substituted for a substituent in the core moiety and may have various energy band gaps.

[0076] In addition, when a compound with an appropriate energy level depending on a substituent is used to fabricate an organic optoelectronic device, the organic optoelectronic device may have excellent efficiency and driving voltage as well as excellent electrochemical and thermal stability and thus, excellent life-span.

[0077] The two different compounds are mixed to prepare an organic material for an organic optoelectronic device, which has luminance; hole or electron properties; film stability; thermal stability; or high triplet excitation energy (T1).

[0078] The at least one compound represented by the following Chemical Formula A-1 may be represented by the following Chemical Formula A-2, and the at least one compound represented by the following Chemical Formula B-1 may be represented by the following Chemical Formula B-2.

[Chemical Formula A-2]

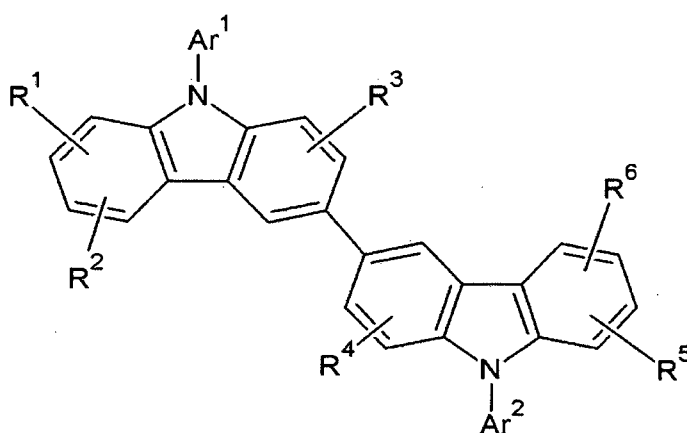

[0079] In Chemical Formula A-2, Ar¹ is a substituted or unsubstituted pyridinyl group, Ar² is hydrogen, deuterium, a C1 to C30 alkyl group, a C6 to C30 aryl group, or a substituted or unsubstituted pyrimidinyl group, and R¹ to R⁶ are the same or different and independently hydrogen, deuterium, a C1 to C30 alkyl group, a C6 to C30 aryl group, or a combination thereof,

[Chemical Formula B-2]

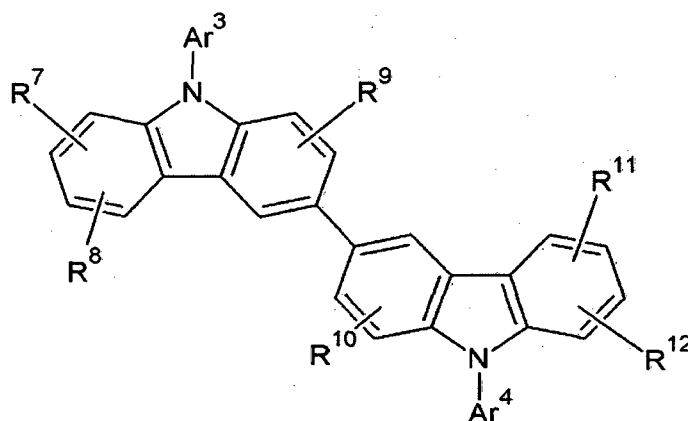

[0080] In Chemical Formula B-2, Ar³ is a substituted or unsubstituted heteroaryl group including at least two nitrogen,

Ar⁴ is hydrogen, deuterium, a C1 to C30 alkyl group, C6 to C30 aryl group, or a substituted or unsubstituted heteroaryl group including at least two nitrogen, and R⁷ to R¹² are the same or different and independently hydrogen, deuterium, a C1 to C30 alkyl group, a C6 to C30 aryl group, or a combination thereof.

[0081] As shown in the above Chemical Formulas A-2 and B-2, when a bicarbazolyl group is bonded at 3-position of each carbazolyl group, compounds represented by the above Chemical Formula A-2 and Chemical Formula B-2 may be easily synthesized.

[0082] The Ar³ may be represented by the Chemical Formula selected from the group consisting of the following Chemical Formulas B-3, B-4, B-5, and B-6.

[Chemical Formula B-3] [Chemical Formula B-4]

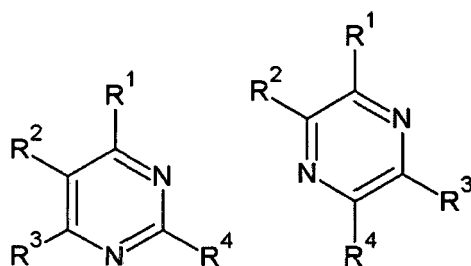

[Chemical Formula B-5] [Chemical Formula B-6]

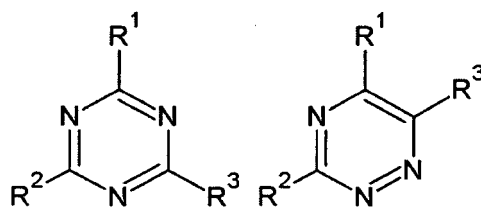

[0083] In Chemical Formulas B-3, B-4, B-5 and B-6, R¹ to R⁴ are the same or different and independently hydrogen, deuterium, a C1 to C30 alkyl group, a C6 to C30 aryl group, or a combination thereof, in Chemical Formulas B-3 and B-4, one of R¹ to R⁴ is a single bond linked to nitrogen of the above Chemical Formula B-1, and in Chemical Formulas B-5 and B-6, and one of R¹ to R³ is a single bond linked to nitrogen of the above Chemical Formula B-1.

[0084] When the Ar³ is one among the above Chemical Formula B-3, B-4, B-5, or B-6, a compound represented by the above Chemical Formula B-1 is mixed with a compound represented by the above Chemical Formula A-1, preparing an organic material for an organic optoelectronic device having an appropriate energy level.

[0085] The Ar² and Ar⁴ may be the same or different and independently substituted phenyl group. Herein, a compound may be prepared to have a bulky structure and thus, have lower crystallinity. The compound with low crystallinity may extend life-span of a device.

[0086] The Ar¹ may be represented by the following Chemical Formula A-3 or Chemical Formula A-4, but is not limited thereto.

[Chemical Formula A-3] [Chemical Formula A-4]

5

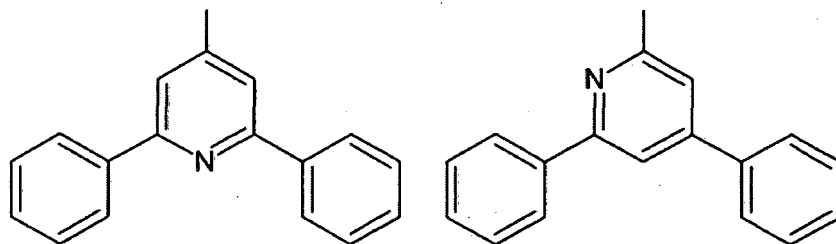

10

[0087] The Ar³ of the above Chemical Formula B-1 may be a substituted or unsubstituted triazinyl group.

[0088] The Ar³ of the above Chemical Formula B-1 may be a substituted or unsubstituted pyrimidinyl group.

[0089] The Ar³ of the above Chemical Formula B-1 may be the following Chemical Formula B-7, B-8 or B-9, but is not limited thereto.

15

[Chemical Formula B-7] [Chemical Formula B-8] [Chemical Formula B-9]

20

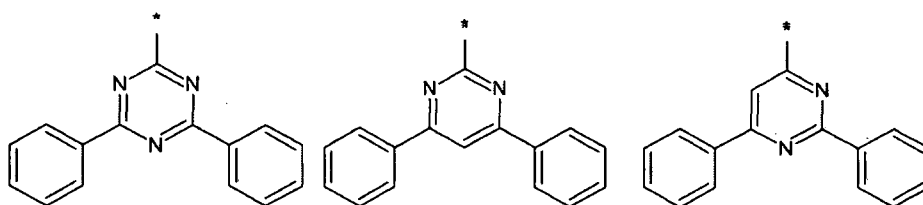

25

[0090] The compounds represented by the above Chemical Formulas A-1 and B-1 may be mixed at a ratio ranging from 1:9 to 9:1, specifically, from 2:8 to 8:2, and more specifically, from 3:7 to 7:3 or 1:1. The mixing ratio of the compounds is selectively controlled depending on desired properties of an organic optoelectronic device.

[0091] The compound represented by the above Chemical Formula A-1 may be represented by one of the following Chemical Formulas A-101 to A-118, but is not limited thereto.

30

[Chemical Formula A-101] [Chemical Formula A-102] [Chemical Formula

35

A-103]

40

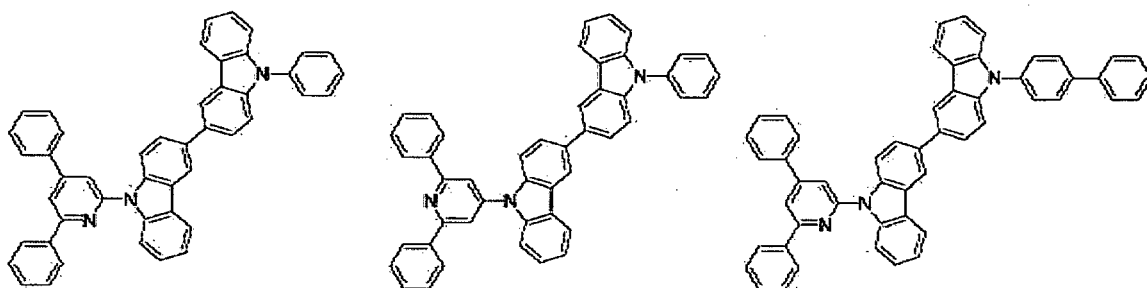

45

50

55

[Chemical Formula A-104] [Chemical Formula A-105] [Chemical Formula

5 A-106]

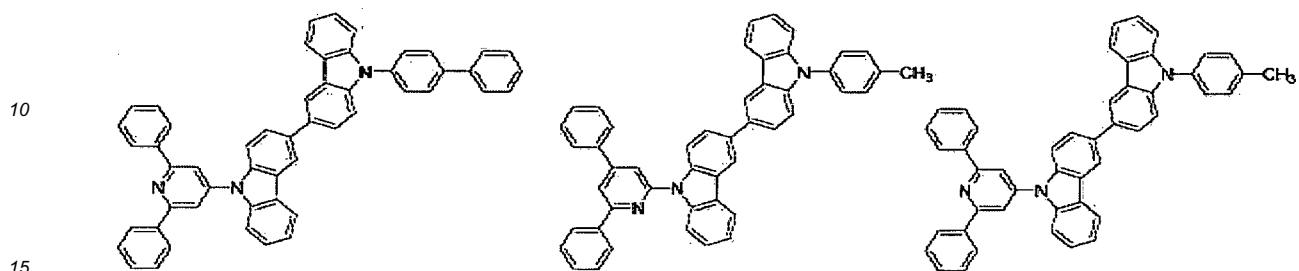

[Chemical Formula A-107] [Chemical Formula A-108] [Chemical Formula

20 A-109]

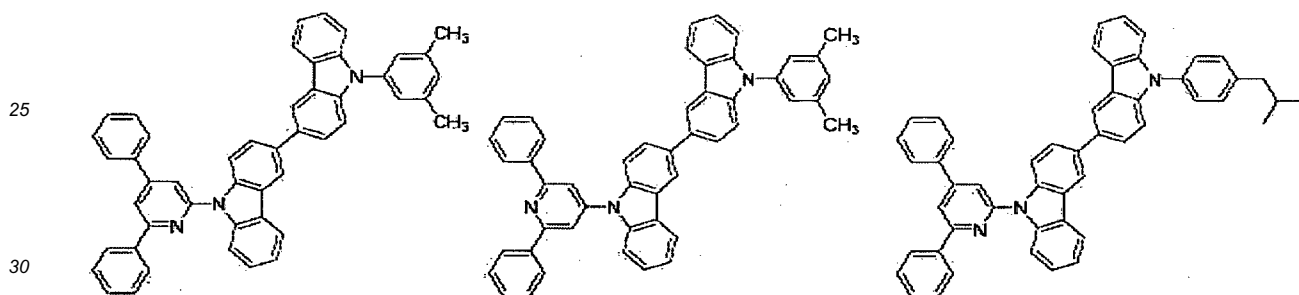

[Chemical Formula A-110] [Chemical Formula A-111] [Chemical Formula

35 A-112]

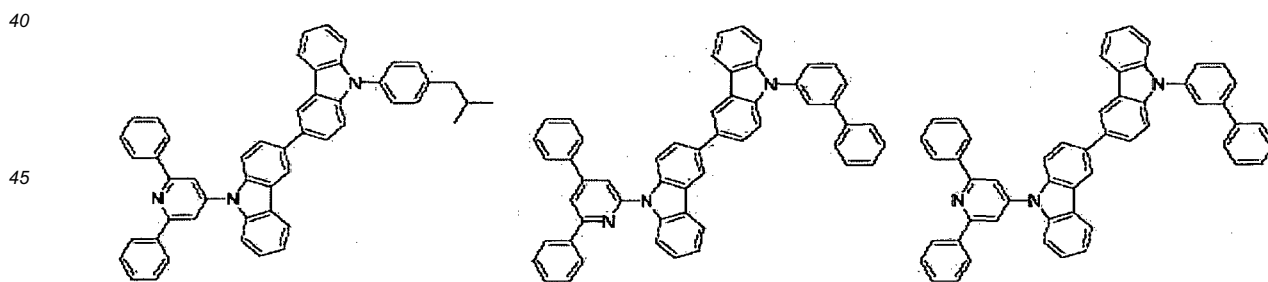

50

55

[Chemical Formula A-113] [Chemical Formula A-114] [Chemical Formula A-115]

5

10

15

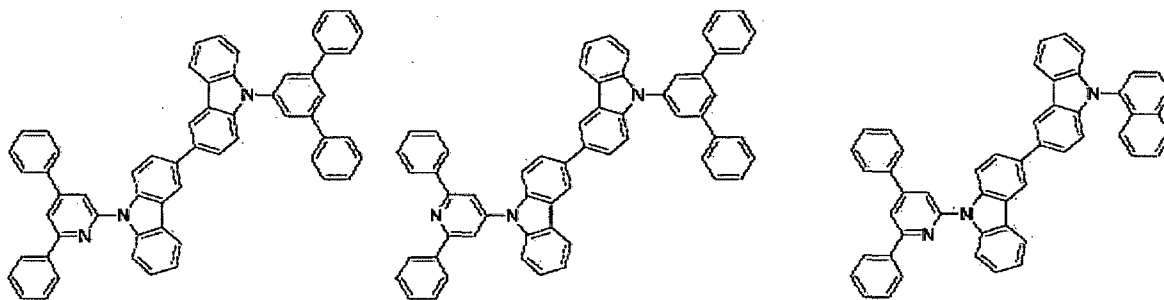

[Chemical Formula A-116] [Chemical Formula A-117] [Chemical Formula A-118]

20

25

30

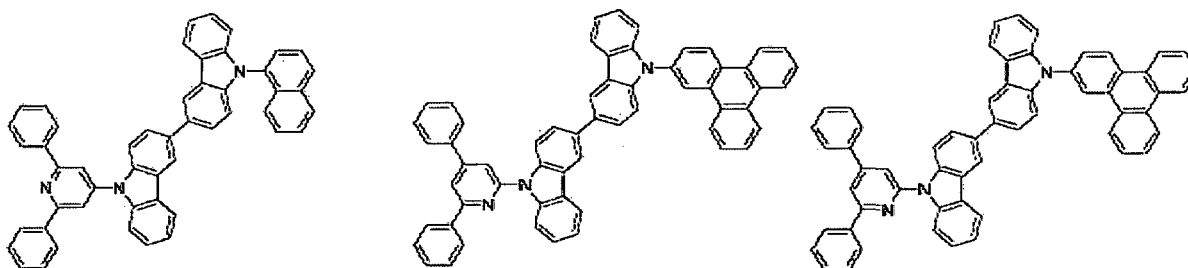

[0092] The compound represented by the above Chemical Formula B-1 may be represented by one of the following Chemical Formulas B-101 to B-109 or B-201 to B-218, but is not limited thereto.

[Chemical Formula B-101] [Chemical Formula B-102] [Chemical Formula B-103]

35

40

45

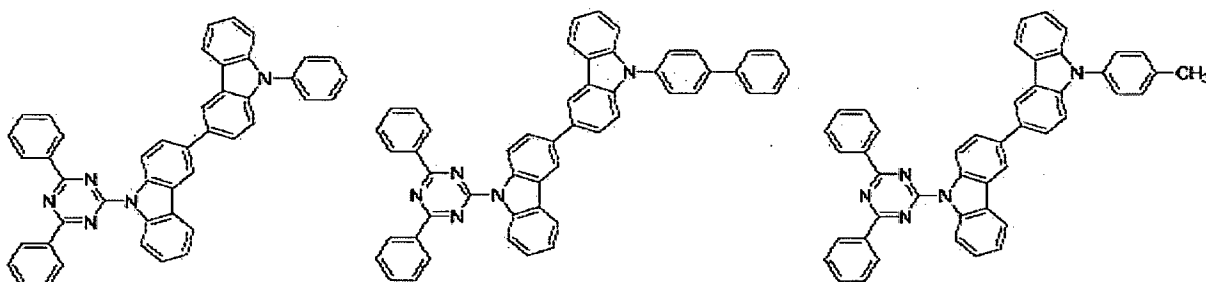

50

55

[Chemical Formula B-104] [Chemical Formula B-105] [Chemical Formula B-106]

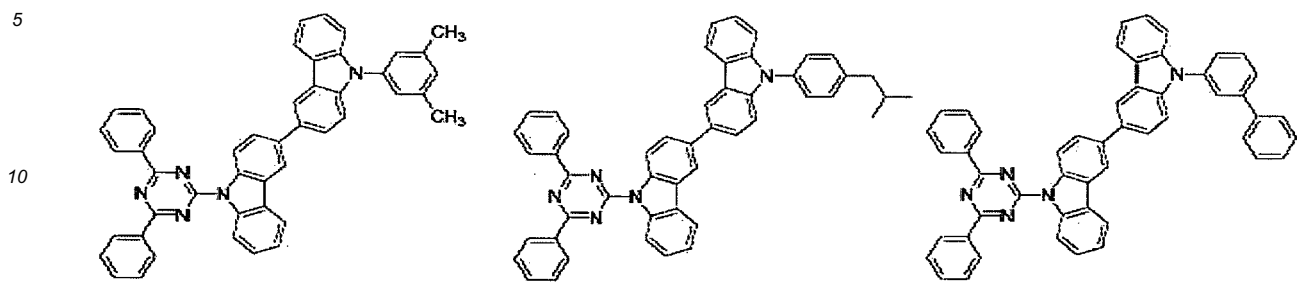

15

[Chemical Formula B-107] [Chemical Formula B-108] [Chemical Formula B-109]

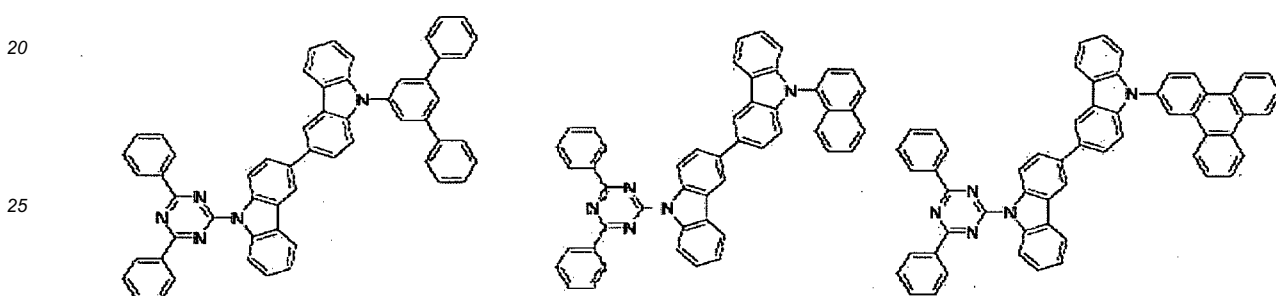

30

[Chemical Formula B-201] [Chemical Formula B-202] [Chemical Formula B-203]

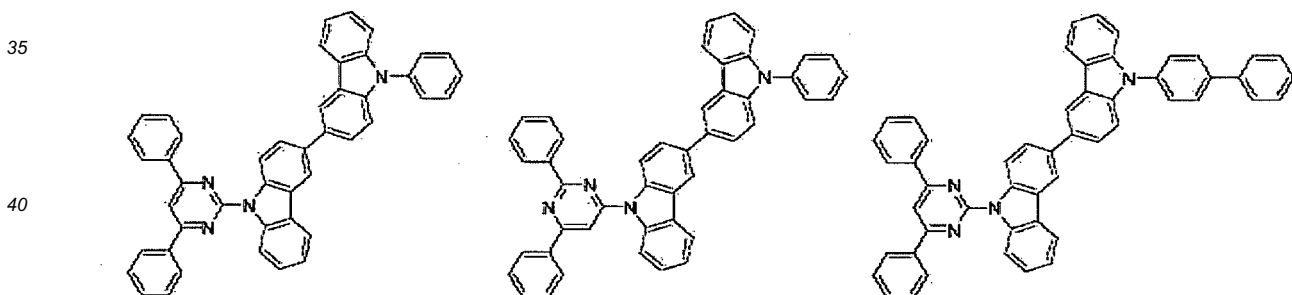

45

[Chemical Formula B-204] [Chemical Formula B-205] [Chemical Formula B-206]

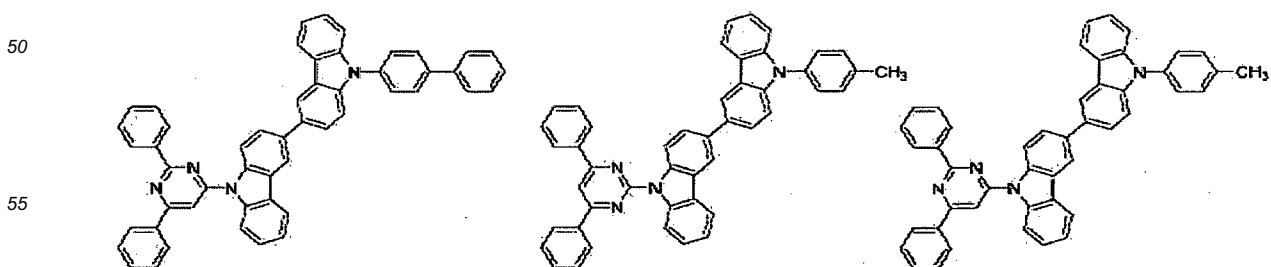

[Chemical Formula B-207] [Chemical Formula B-208] [Chemical Formula B-209]

5

10

15

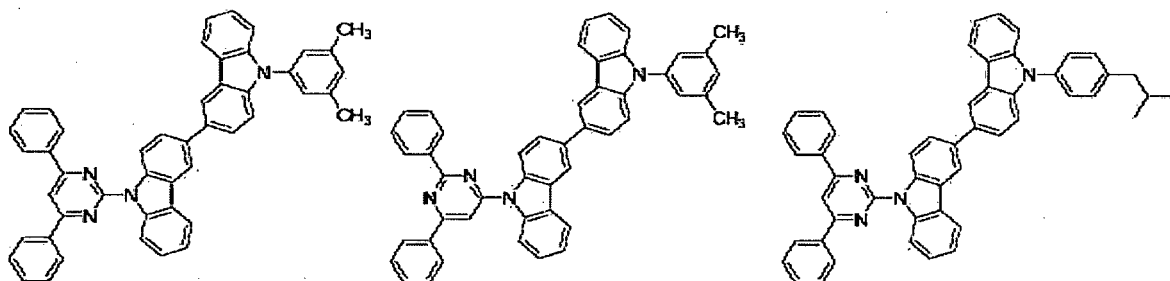

20

[Chemical Formula B-210] [Chemical Formula B-211] [Chemical Formula B-212]

25

30

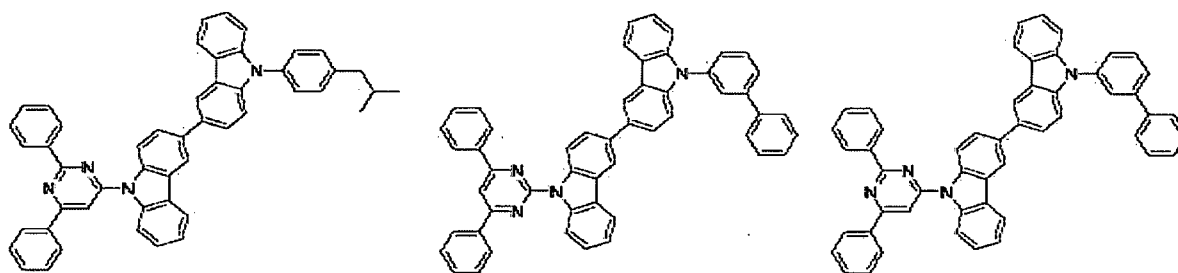

35

[Chemical Formula B-213] [Chemical Formula B-214] [Chemical Formula B-215]

40

45

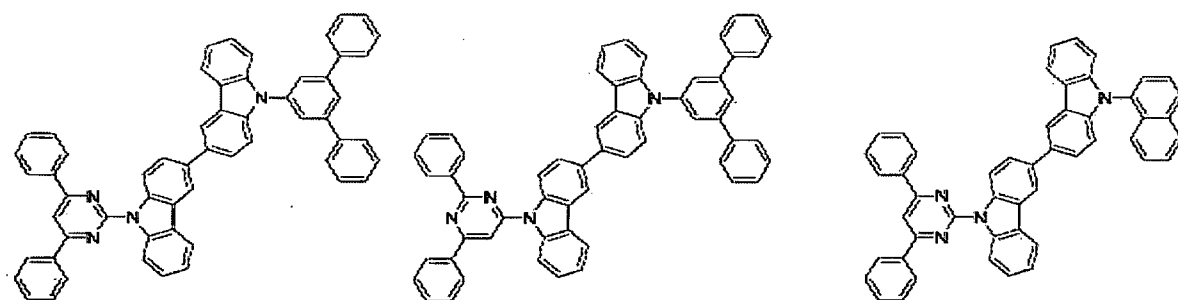

50

55

[Chemical Formula B-216] [Chemical Formula B-217] [Chemical Formula B-218]

5

10

15

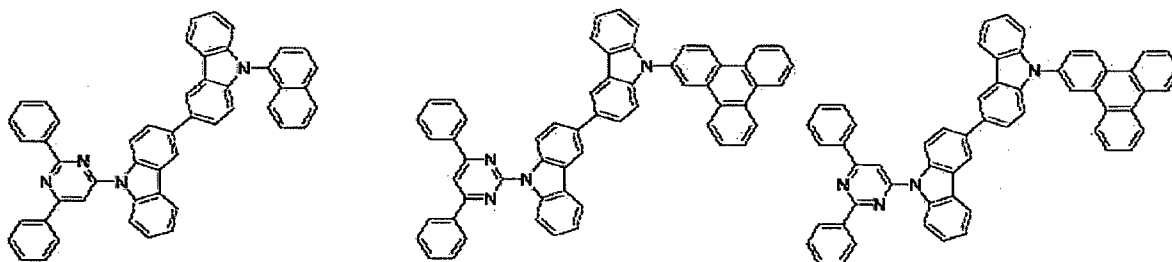

20

25

30

35

40

45

50

55

[0093] According to the embodiment of the present invention, the material for an organic optoelectronic device has a maximum light emitting wavelength ranging from 320 to 500 nm and triplet excitation energy of 2.0 eV or more (T1), and specifically, ranging from 2.0 to 4.0 eV. When it has this high excitation energy, it can transport a charge to a dopant well and improve luminous efficiency of the dopant, and can also decrease the driving voltage by freely regulating HOMO and LUMO energy levels. Accordingly, it can be usefully applied as a host material or a charge-transporting material.

[0094] The material for an organic optoelectronic device may be also used as a nonlinear optical material, an electrode material, a chromic material, and as a material applicable to an optical switch, a sensor, a module, a waveguide, an organic transistor, a laser, an optical absorber, a dielectric material, and a membrane due to its optical and electrical properties.

[0095] The material for an organic optoelectronic device including the above compound has a glass transition temperature of 90°C or higher and a thermal decomposition temperature of 400°C or higher, so as to improve thermal stability. Thereby, it is possible to produce an organic optoelectronic device having a high efficiency.

[0096] The material for an organic optoelectronic device including the above compound may play a role in emitting light or injecting and/or transporting electrons, and it may act as a light emitting host together with a suitable dopant. In other words, the material for an organic optoelectronic device may be used as a phosphorescent or fluorescent host material, a blue light emitting dopant material, or an electron transporting material.

[0097] Since the material for an organic optoelectronic device according to one embodiment is used for an organic thin layer, it may improve the life span characteristic, efficiency characteristic, electrochemical stability, and thermal stability of an organic optoelectronic device, and decrease the driving voltage.

[0098] Therefore, according to another embodiment, an organic optoelectronic device is provided that includes the material for an organic optoelectronic device. The organic optoelectronic device may refer to an organic photoelectric device, an organic light emitting diode, an organic solar cell, an organic transistor, an organic photo-conductor drum, an organic memory device, and the like. For example, the material for an organic optoelectronic device according to one embodiment may be included in an electrode or an electrode buffer layer in the organic solar cell to improve quantum efficiency, and it may be used as an electrode material for a gate, a source-drain electrode, or the like in the organic transistor.

[0099] Hereinafter, a detailed described relating to the organic light emitting diode will be provided.

[0100] According to another embodiment of the present invention, an organic light emitting diode includes an anode, a cathode, and at least one organic thin layer interposed between the anode and the cathode, wherein at least one organic thin layer may provide an organic optoelectronic device including the material for an organic optoelectronic device according to one embodiment.

[0101] The organic thin layer that may include the material for an organic optoelectronic device may include a layer selected from the group consisting of an emission layer, a hole transport layer (HTL), a hole injection layer (HIL), an electron transport layer (ETL), an electron injection layer (EIL), a hole blocking film, and a combination thereof. At least one layer includes the material for an organic optoelectronic device according to one embodiment. Particularly, the electron transport layer (ETL) or the electron injection layer (EIL) may include the material for an organic optoelectronic device according to one embodiment. In addition, when the material for an organic photoelectric device is included in the emission layer, the compound for an organic photoelectric device may be included as a phosphorescent or fluorescent host, and particularly, as a fluorescent blue dopant material.

[0102] FIGS. 1 to 5 are cross-sectional views showing an organic light emitting diode including the compound for an organic optoelectronic device according to one embodiment of the present invention.

[0103] Referring to FIGS. 1 to 5, organic light emitting diodes 100, 200, 300, 400, and 500 according to one embodiment include at least one organic thin layer 105 interposed between an anode 120 and a cathode 110.

[0104] The anode 120 includes an anode material having a large work function to help hole injection into an organic thin layer. The anode material includes: a metal such as nickel, platinum, vanadium, chromium, copper, zinc, and gold, or alloys thereof; a metal oxide such as zinc oxide, indium oxide, indium tin oxide (ITO), and indium zinc oxide (IZO); a combined metal and oxide such as ZnO:Al or SnO₂:Sb; or a conductive polymer such as poly(3-methylthiophene), poly[3,4-(ethylene-1,2-dioxy)thiophene] (PEDT), polypyrrole, and polyaniline, but is not limited thereto. In one embodiment, it is preferable to include a transparent electrode including indium tin oxide (ITO) as an anode.

[0105] The cathode 110 includes a cathode material having a small work function to help electron injection into an organic thin layer. The cathode material includes: a metal such as magnesium, calcium, sodium, potassium, titanium, indium, yttrium, lithium, gadolinium, aluminum, silver, tin, lead, cesium, barium, and the like, or alloys thereof, or a multi-layered material such as LiF/Al, LiO₂/Al, LiF/Ca, LiF/Al, and BaF₂/Ca, but is not limited thereto. In one embodiment, it is preferable to include a metal electrode including aluminum as a cathode.

[0106] Referring to FIG. 1, the organic light emitting diode 100 includes an organic thin layer 105 including only an emission layer 130.

[0107] Referring to FIG. 2, a double-layered organic light emitting diode 200 includes an organic thin layer 105 including an emission layer 230 including an electron transport layer (ETL), and a hole transport layer (HTL) 140. The emission layer 130 also functions as an electron transport layer (ETL), and the hole transport layer (HTL) 140 layer has an excellent binding property with a transparent electrode such as ITO or an excellent hole transporting property.

[0108] Referring to FIG. 3, a three-layered organic light emitting diode 300 includes an organic thin layer 105 including an electron transport layer (ETL) 150, an emission layer 130, and a hole transport layer (HTL) 140. The emission layer 130 is independently installed, and layers having an excellent electron transporting property or an excellent hole transporting property are separately stacked.

[0109] As shown in FIG. 4, a four-layered organic light emitting diode 400 includes an organic thin layer 105 including an electron injection layer (EIL) 160, an emission layer 130, a hole transport layer (HTL) 140, and a hole injection layer (HIL) 170 for binding with the cathode of ITO.

[0110] As shown in FIG. 5, a five layered organic light emitting diode 500 includes an organic thin layer 105 including an electron transport layer (ETL) 150, an emission layer 130, a hole transport layer (HTL) 140, and a hole injection layer (HIL) 170, and further includes an electron injection layer (EIL) 160 to achieve a low voltage.

[0111] In FIG. 1 to FIG. 5, the organic thin layer 105 including at least one selected from the group consisting of an electron transport layer (ETL) 150, an electron injection layer (EIL) 160, an emission layer 130 and 230, a hole transport layer (HTL) 140, a hole injection layer (HIL) 170, and combinations thereof includes the compound for an organic optoelectronic device. The material for an organic optoelectronic device may be used for an electron transport layer (ETL) 150 including the electron transport layer (ETL) 150 or electron injection layer (EIL) 160. When it is used for the electron transport layer (ETL), it is possible to provide an organic light emitting diode having a simpler structure because it does not require an additional hole blocking layer (not shown).

[0112] Furthermore, when the material for an organic optoelectronic device is included in the emission layers 130 and 230, the material for an organic optoelectronic device may be included as a phosphorescent or fluorescent host or a fluorescent blue dopant.

[0113] The organic light emitting diode may be fabricated by: forming an anode on a substrate; forming an organic thin layer in accordance with a dry coating method such as evaporation, sputtering, plasma plating, and ion plating, or a wet coating method such as spin coating, dipping, and flow coating; and providing a cathode thereon.

[0114] The organic thin layer may be formed in various methods. Herein, two different compounds according to one embodiment of the present invention may be simultaneously or sequentially formed into an organic thin layer.

[0115] For example, the compounds represented by the above Chemical Formulas A-1 and B-1 are mixed to prepare a mixture, and the mixture may be deposited to form an organic thin layer on an anode.

[0116] In addition, the compounds represented by the above Chemical Formulas A-1 and B-1 are separately prepared and then, simultaneously or sequentially deposited on the anode.

[0117] The deposition may vary depending on desired effects but is not limited thereto.

[0118] Another embodiment of the present invention provides a display device including the organic light emitting diode according to the above embodiment.

[0119] Hereinafter, the embodiments are illustrated in more detail with reference to examples. However, the following are exemplary embodiments and are not limiting.

(Preparation of compound for an organic optoelectronic device)

Synthesis Example 1: Preparation of Compound A-101

[0120]

[Reaction Scheme 1]

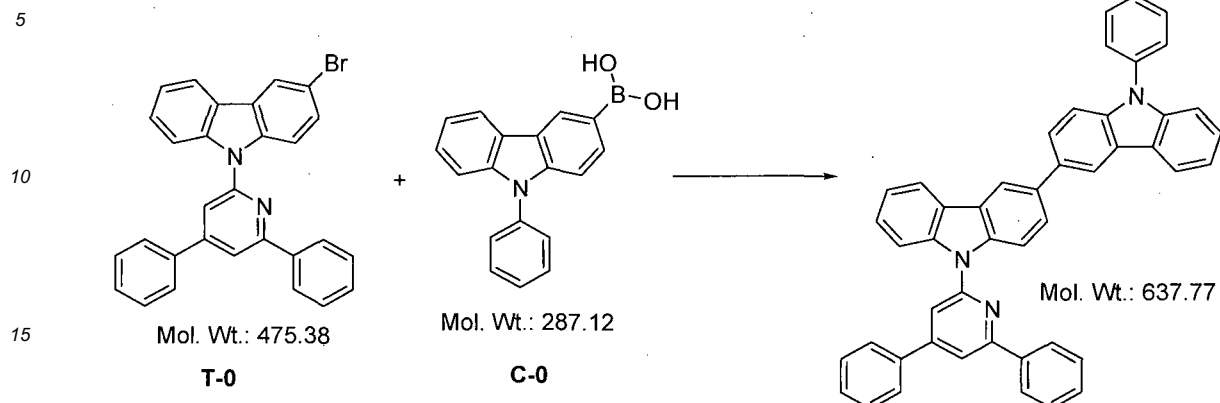

20 [0121] 9.5g of an intermediate compound T-0 and 6.9g of an intermediate compound C-0 were dissolved in 100 ml of tetrahydrofuran in a 250ml round-bottomed flask with a thermometer, a reflux-condenser, and an agitator under nitrogen atmosphere, and 80 ml of a 2M-potassiumcarbonate aqueous solution was added thereto. Next, 1.2 g of tetrakis(triphenylphosphine) palladium was added to the mixture and refluxed for 12 hours. When the reaction was complete, the reactant was several times extracted with methylene chloride, treated with anhydrous sulfuric acid magnesium to remove moisture, and filtrated, and then, the solvent was removed therefrom.

25 [0122] The resulting reactant was purified by performing column chromatography and recrystallization, obtaining 10.2g of a compound A-101.

Synthesis Example 2: Preparation of Compound A-103

30 [0123]

[Reaction Scheme 2]

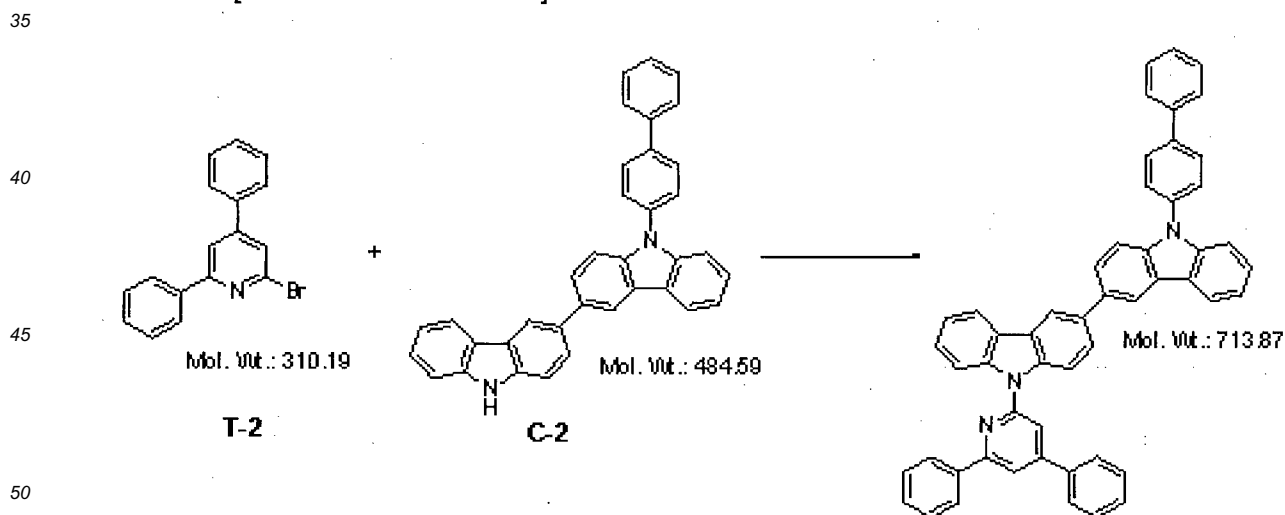

55 [0124] 7.4g of an intermediate compound T-2 and 9.7g of an intermediate compound C-2 were dissolved in 100ml of toluene in a 250ml round-bottomed flask with a thermometer, a reflux-condenser, and an agitator under a nitrogen atmosphere, and 0.3g of sodium tert-butoxide, 0.9g of palladium dibenzylideneamine, and 0.4g of tertiarybutyl phosphorus were added thereto. The mixture was refluxed for 12 hours. When the reaction was complete, the reactant was several times extracted with methylenechloride, treated with anhydrous sulfuric acid magnesium to remove moisture, and then, the solvent was removed therefrom.

[0125] The reactant was recrystallized for purification, obtaining 10.7g of a compound A-103. The compound A-103 synthesized as LC-Mass had a $[M+H]^+$ molecular weight of 715.31.

Synthesis Example 3: Preparation of Compound B-103

[0126]

[Reaction Scheme 3]

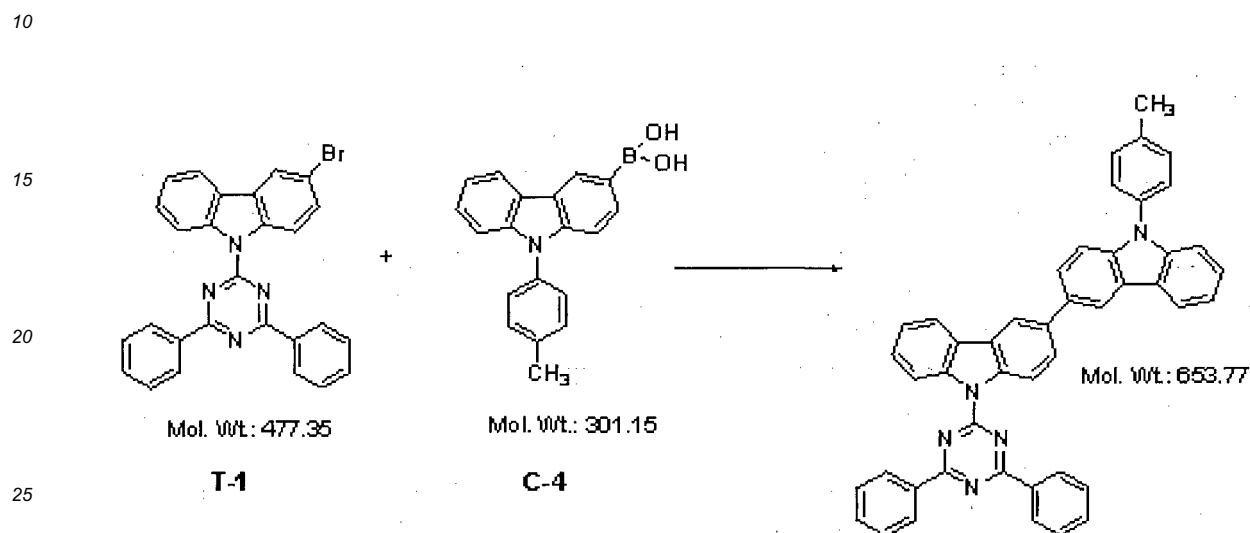

30 [0127] 9.5g of an intermediate compound T-3 and 7.2g of an intermediate compound C-4 were dissolved in 100 ml of tetrahydrofuran in a 250ml round-bottomed flask with a thermometer, a reflux-condenser, and an agitator under a nitrogen atmosphere, and 80 ml of a 2M-potassiumcarbonate aqueous solution was added thereto. Then, 1.2 g of tetrakis(triphenylphosphine) palladium was added to the mixture. The resulting mixture was refluxed for 12 hours. When the reaction was complete, the reactant was several times extracted with methylene chloride, treated with anhydrous sulfuric acid magnesium to remove moisture, and filtrated, and then, the solvent was removed therefrom.

35 [0128] The resulting reactant was purified by performing column chromatography and recrystallization, obtaining 8.5g of a compound B-103. The compound B-103 synthesized as LC-Mass had 654.74 of a $[M+H]^+$ molecular weight.

Synthesis Example 4: Preparation of Compound B-106

40 [0129]

[Reaction Scheme 4]

45

50

55

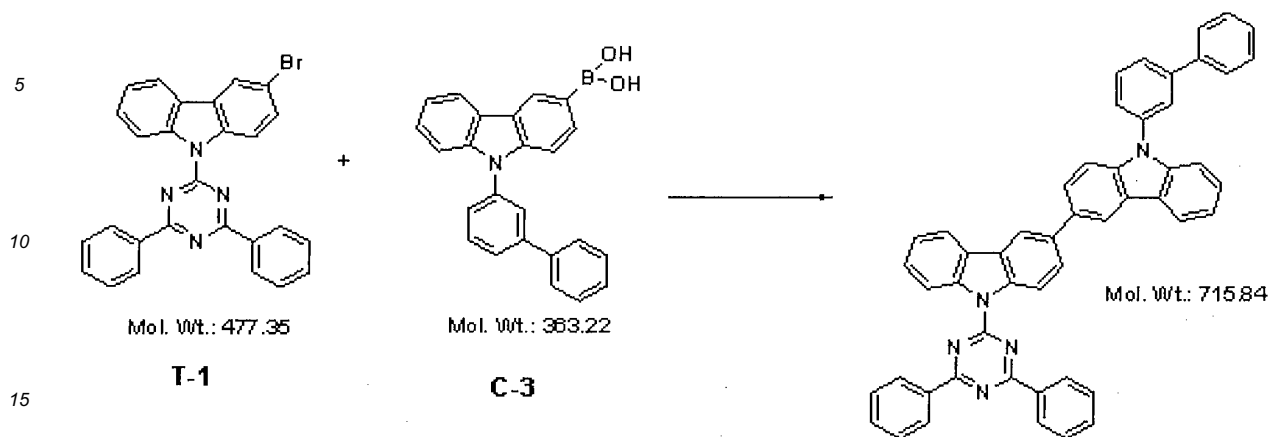

[0130] 9.6g of an intermediate compound T-1 and 8.7g of an intermediate compound C-3 was dissolved in 100 ml of tetrahydrofuran, and 80 ml of a 2M-potassiumcarbonate aqueous solution in a 250ml round-bottomed flask with a thermometer, a reflux-condenser, and an agitator under a nitrogen atmosphere. Then, 1.2 g of tetrakis(triphenyl)phosphine palladium was added to the mixture. The resulting mixture was refluxed for 12 hours. When the reaction was complete, the reactant was several times extracted with methylenechloride, treated with anhydrous sulfuric acid magnesium to remove moisture, and filtrated, and then, the solvent was removed therefrom.

[0131] The reactant was recrystallized for purification, obtaining 10.7g of a compound B-106. The compound B-106 synthesized as LC-Mass had 717.42 of a $[M+H]^+$ molecular weight.

Synthesis Example 5: Preparation of Compound B-205

[0132]

[Reaction Scheme 5]

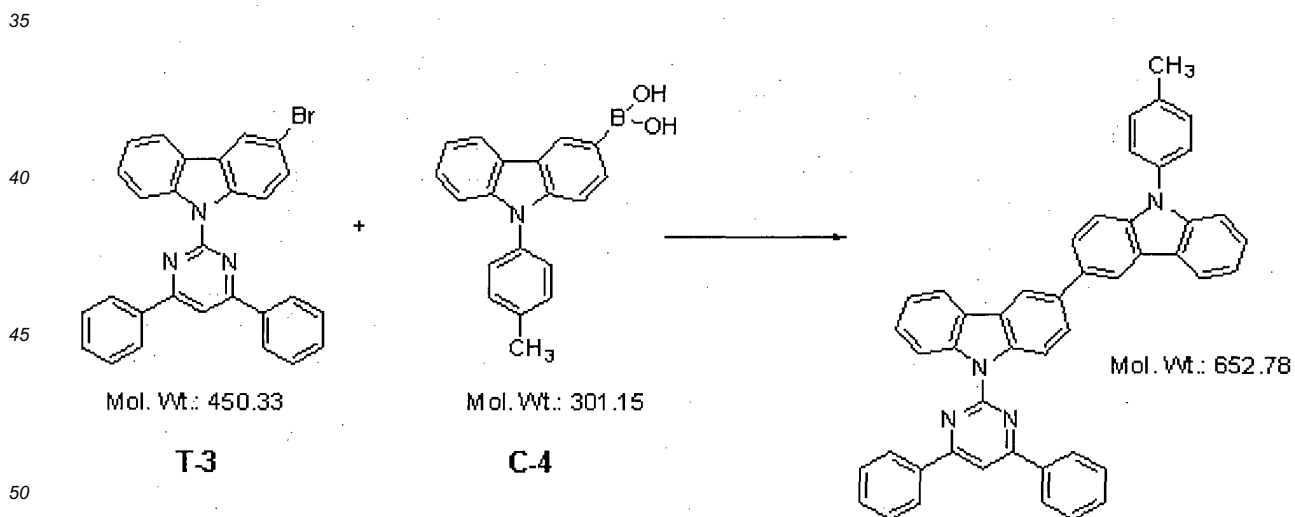

[0133] 9.0g of an intermediate compound T-3 and 7.2g of an intermediate compound C-4 were dissolved in 100 ml of tetrahydrofuran in a 250ml round-bottomed flask with a thermometer, a reflux-condenser, and an agitator under a nitrogen atmosphere, and 80 ml of a 2M-potassiumcarbonate aqueous solution was added thereto. Next, 1.2 g of tetrakis(triphenyl)phosphine palladium was added to the mixture. The resulting mixture was refluxed for 12 hours. When the reaction was complete, the reactant was several times extracted with methylenechloride, treated with anhydrous sulfuric acid magnesium to remove moisture, and filtrated, and then, the solvent was removed therefrom.

[0134] The resulting reactant was purified by performing column chromatography and recrystallization, obtaining 9.2g of a compound B-205. The compound B-205 synthesized as LC-Mass had 654.74 of a $[M+H]^+$ molecular weight.

Synthesis Example 6: Preparation of Compound B-211

[0135]

[Reaction Scheme 6]

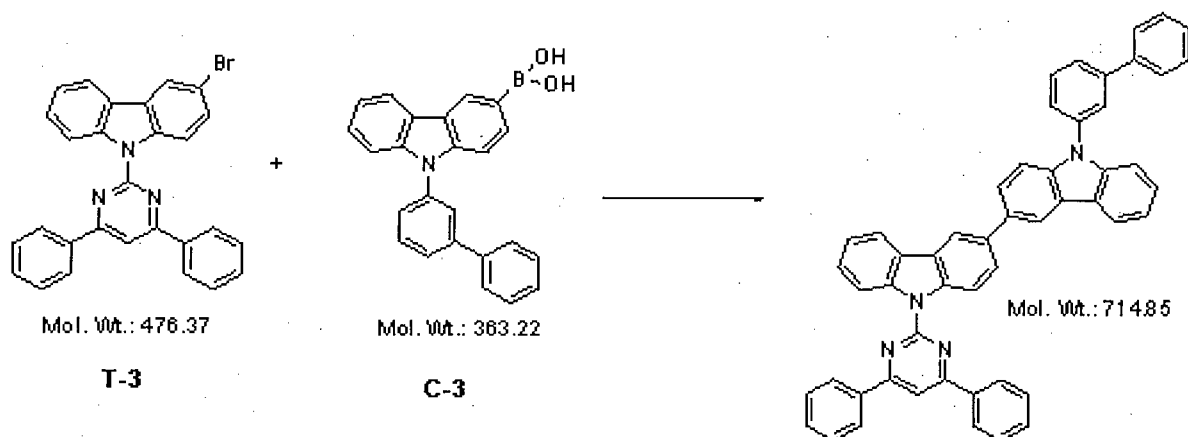

[0136] 9.5g of an intermediate compound T-3 and 8.7g of an intermediate compound C-3 were dissolved in 100 ml of tetrahydrofuran in a 250ml round-bottomed flask with a thermometer, a reflux-condenser, and an agitator, and 80 ml of a 2M-potassiumcarbonate aqueous solution was added thereto. Then, 1.2 g of tetrakis(triphenyl)phosphine palladium was added to the mixture, and the resulting mixture was refluxed for 12 hours. When the reaction was complete, the reactant was several times extracted with methylenechloride, treated with anhydrous sulfuric acid magnesium to remove moisture, and filtered, and then, the solvent was removed therefrom.

[0137] The resulting reactant was recrystallized for purification, obtaining 12.1g of a compound B-211. The compound B-211 synthesized as LC-Mass had 715.86 of a $[M+H]^+$ molecular weight.

(Preparation of Organic Light Emitting Diode)

Example 1: Mixing Compounds A-101 and B-103 at 1:1

[0138] A glass substrate coated with ITO (Indium tin oxide) to be 1500Å thick was washed with ultrasonic wave using distilled water.

[0139] Next, the substrate was washed with ultrasonic wave using a solvent such as isopropyl alcohol, acetone, methanol, and the like.

[0140] Then, the substrate was moved to a plasma cleaner and cleaned with an oxygen plasma for 5 minutes and then, moved to a vacuum depositor.

[0141] This ITO transparent electrode was used as a anode, and the following HTM compound was vacuum-deposited to form a 1200Å-thick hole injection layer (HIL) thereon.

[HTM]

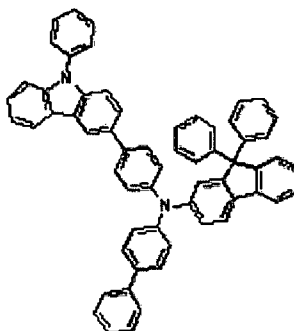

[0142] On the hole transport layer (HTL), a mixture prepared by mixing the compound A-101 and the compound B-103 in a ratio of 1:1 was used as a host, while the following PhGD compound as a green phosphorescent dopant was doped thereon in an amount of 7wt% to form a 300Å-thick emission layer in a vacuum-deposition.

[PhGD]

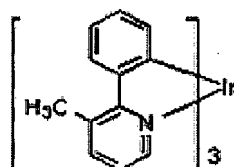

[0143] On the emission layer, the following BALq[Bis (2-methyl-8-quinolinolato-N1,O8)-(1,1'-Biphenyl-4-olato)aluminum] compound and sequentially, the following Alq3[Tris(8-hydroxyquinolinato)aluminium] compound were laminated to be 50Å thick and 250Å thick thereon, forming an electron transport layer (ETL). On the electron transport layer (ETL), 5Å-thick LiF and 1000Å-thick Al were sequentially vacuum deposited to fabricate a cathode. The cathode was used to fabricate an organic light emitting diode.

[Balq] [Alq3]

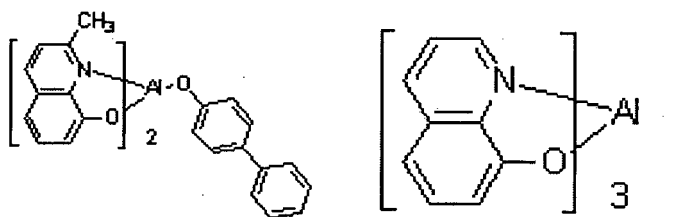

Example 2: Mixing Compounds A-101 and B-205 at 1:1

[0144] An organic light emitting diode was fabricated according to the same method as Example 1 except for using a mixture of the compounds A-101 and B-205 mixed in a ratio of 1:1 instead of the mixture of the compounds A-101 and B-103 mixed in a ratio of 1:1.

Example 3: Mixing Compounds A-101 and B-106 at 1:1

[0145] An organic light emitting diode was fabricated according to the same method as Example 1 except for using a mixture of the compounds A-101 and B-106 mixed in a ratio of 1:1 instead of the mixture of the compounds A-101 and B-103 mixed in a ratio of 1:1.

Example 4: Mixing Compounds A-101 and B-211 at 1:1

5 [0146] An organic light emitting diode was fabricated according to the same method as Example 1 except for using a mixture of the compounds A-101 and B-211 mixed in a ratio of 1:1 instead of the mixture of the compounds A-101 and B-103 mixed in a ratio of 1:1.

Example 5: Mixing Compounds A-103 and B-103 at 1:1

10 [0147] An organic light emitting diode was fabricated according to the same method as Example 1 except for using a mixture of the compounds A-103 and B-211 mixed in a ratio of 1:1 instead of the mixture of the compounds A-101 and B-103 mixed in a ratio of 1:1.

Comparative Example 1: Compound A-101

15 [0148] An organic light emitting diode was fabricated according to the same method as Example 1 except for using the compound A-101 instead of the mixture of the compounds A-101 and B-103 mixed in a ratio of 1:1.

Comparative Example 2: Compound B-103

20 [0149] An organic light emitting diode was fabricated according to the same method as Example 1 except for using the compound B-103 instead of the mixture of the compounds A-101 and B-103 mixed in a ratio of 1:1.

Comparative Example 3: Compound B-205

25 [0150] An organic light emitting diode was fabricated according to the same method as Example 1 except for using the compound B-205 instead of the mixture of the compounds A-101 and B-103 mixed in a ratio of 1:1.

Comparative Example 4: Compound B-106

30 [0151] An organic light emitting diode was fabricated according to the same method as Example 1 except for using the compound B-106 instead of the mixture of the compounds A-101 and B-103 mixed in a ratio of 1:1.

Comparative Example 5: Compound B-211

35 [0152] An organic light emitting diode was fabricated according to the same method as Example 1 except for using the compound B-211 instead of the mixture of the compounds A-101 and B-103 mixed in a ratio of 1:1.

Comparative Example 6: Compound A-103

40 [0153] An organic light emitting diode was fabricated according to the same method as Example 1 except for using the compound A-103 instead of the mixture of the compounds A-101 and B-103 mixed in a ratio of 1:1.

Performance Evaluation of Organic light emitting diode

45 [0154] Each organic light emitting diode according to Examples 1 to 5 and Comparative Examples 1 to 6 was measured regarding current density change and luminance change depending on a voltage and luminous efficiency. The measurement method is in particular as follows.

50 (1) Current density change depending on Voltage change

[0155] The organic light emitting diodes were measured regarding current flowing in a unit device by using a current-voltage meter (Keithley 2400) while a voltage was increased from 0 V to 10 V. The current measurement was divided by an area to calculate current density.

55 (2) Luminance change depending on voltage change

[0156] The organic light emitting diodes were measured regarding luminance by using a luminance meter (Minolta Cs-1000A) while a voltage was increased from 0 V to 10 V.

EP 2 675 867 B1

(3) Luminous efficiency

[0157] The luminance and current density obtained from the above (1) and (2) and a voltage were used to calculate current efficiency (cd/A) at the same current density (10 mA/cm²).

(4) Life-span characteristic evaluation

[0158] The organic light emitting diodes were measured regarding time (h) taking from their initial luminance of 3000cd/m² to decrease down to 2910cd/m² by 3%.

[0159] The following Table 1 shows the evaluation results of the organic light emitting diodes according to Example 1 and Comparative Examples 1 and 2.

(Table 1)

	Vd(V)	Cd/A	lm/W	Cd/m ²	CIEx	CIEx	Life-span(h)
Comparative Example 1	5.14	58.4	35.7	3000	0.335	0.624	20
Comparative Example 2	5.11	62.4	38.4	3000	0.337	0.624	130
Example 1	4.92	63.7	40.7	3000	0.334	0.626	151

[0160] The device using more than two compounds according to Example 1 had excellent efficiency and characteristic compared with the devices according to Comparative Examples 1 and 2.

[0161] The following Table 2 shows the evaluation results of the devices according to Example 2 and Comparative Examples 1 and 3.

(Table 2)

	Vd(V)	Cd/A	lm/W	Cd/m ²	CIEx	CIEx	Life-span (h)
Comparative Example 1	5.14	58.4	35.7	3000	0.335	0.624	20
Comparative Example 3	4.91	66.3	42.5	3000	0.339	0.623	36
Example 2	4.84	65.0	42.2	3000	0.331	0.628	63

[0162] The device using more than two compounds according to Example 2 had equal efficiency to the device of Comparative Examples 1 and 3 but remarkably improved life-span characteristic.

[0163] The following Table 3 show the evaluation results of the devices according to Example 3 and Comparative Examples 1 and 4.

(Table 3)

	Vd(V)	Cd/A	lm/W	Cd/m ²	CIEx	CIEx	Life-span (h)
Comparative Example 1	5.14	58.4	35.7	3000	0.335	0.624	20
Comparative Example 4	5.32	64.9	38.4	3000	0.340	0.621	100
Example 3	5.02	65.3	40.9	3000	0.341	0.621	123

[0164] The device using more than two compounds according to Example 3 had excellent device efficiency and characteristic compared with the devices of Comparative Examples 1 and 4.

[0165] The following Table 4 shows the evaluation results of the devices according to Example 4 and Comparative Examples 1 and 5.

(Table 4)

	Vd(V)	Cd/A	lm/W	Cd/m ²	CIEx	CIEx	Life-span (h)
Comparative Example 1	5.14	58.4	35.7	3000	0.335	0.624	20
Comparative Example 5	4.84	66.6	43.3	3000	0.340	0.621	78

EP 2 675 867 B1

(continued)

	Vd(V)	Cd/A	Im/W	Cd/m ²	CIE _x	CIE _y	Life-span (h)
Example 4	4.85	65.7	42.7	3000	0.338	0.623	108

[0166] The devices using two compounds according to Example 4 had equal efficiency to the devices according to Comparative Examples 1 and 5 but much improved life-span characteristic.

[0167] The following Table 5 shows the evaluation results of the devices according to Example 5 and Comparative Examples 2 and 6.

(Table 5)

	Vd(V)	Cd/A	Im/W	Cd/m ²	CIE _x	CIE _y	Life-span (h)
Comparative Example 6	5.02	58.4	35.7	3000	0.335	0.624	36
Comparative Example 2	5.11	62.4	38.4	3000	0.337	0.624	130
Example 5	4.87	64.2	41.5	3000	0.333	0.627	194

[0168] The devices using two compounds according to Example 5 had excellent efficiency and characteristic compared with the devices according to Comparative Examples 2 and 6.

[0169] FIG. 6 provides data evaluating life-span characteristic of the organic light emitting diodes according to Examples 1 to 4 and Comparative Examples 1 to 5.

[0170] FIG. 7 provides data evaluating life-span characteristic of the organic light emitting diodes according to Example 5 and Comparative Example 6.

[0171] As shown in Table 1 to 5 and FIG. 6 and 7, the organic light emitting diode using more than two compounds according to an exemplary embodiment of the present invention had excellent characteristic such as efficiency, life-span, and the like.

(Energy Level of Compound)

[0172] The compounds A-101, A-103, B-205, B-211, B-103, and B-106 were measured regarding energy level.

[0173] The energy levels of the compounds were calculated by using a B3LYP/6-31G set of Gaussian 03 package, and the results are provided in the following Table 6.

(Table 6)

Material	HOMO (eV)	LUMO (eV)	Δ E (T1)	Δ E (S1)
B-101	-5.16	-1.89	2.83	2.90
B-102	-5.14	-1.89	2.83	2.89
B-106	-5.15	-1.89	2.82	2.89
B-103	-5.12	-1.88	2.82	2.88
B-201	-5.05	-1.72	2.78	2.93
B-211	-5.03	-1.77	2.71	2.84
B-205	-5.00	-1.76	2.71	2.84
A-101	-4.97	-1.45	2.91	3.09
A-103	-4.97	-1.46	2.91	3.08

[0174] The compounds had a HOMO energy level ranging of about -5.0 to -5.1 eV and thus, similar hole properties, which are located between electron transport layer (ETL) material and hole transport layer (HTL) material and shows an appropriate energy level.

[0175] The compounds had various LUMO energy levels depending on a substituent. The compound including a pyrimidinyl group and the compound including a triazinyl group had more than 0.3eV a lower LUMO energy level than the compound including a pyridinyl group.

[0176] Accordingly, the compounds respectively including a pyrimidinyl group and a triazinyl group are expected to have much excellent electron properties.

(Mixing ratio of Compound of Example 1)

[0177] Two compounds used in the organic light emitting diode according to Example 1 were measured regarding mixing ratio. The mixing ratio was identified through a liquid chromatography (High Performance Liquid Chromatography, HPLC) ratio.

[0178] FIG. 8 shows 100% liquid chromatography result of the compound A-101. The compound A-101 had a peak at the retention time of about 19 minutes.

[0179] FIG. 9 shows the liquid chromatography result of the compound B-103 99.98%. The compound B-103 had a peak at the retention time of about 27 minutes.

[0180] FIG. 10 shows that the peak areas at 19 and 27 minutes had a ratio of 1:1 of a ratio based on the liquid chromatography results about materials used in an emission layer for an organic light emitting diode.

<Description of symbols>

[0181]

100 : organic light emitting diode 110 : cathode

120 : anode 105 : organic thin layer

130 : emission layer 140 : hole transport layer (HTL)

150 : electron transport layer (ETL) 160 : electron injection layer (EIL)

170 : hole injection layer (HIL) 230: emission layer + electron transport layer (ETL)

Claims

1. A material for an organic optoelectronic device, comprising:
at least one compound represented by the following Chemical Formula A-1; and at least one compound represented by the following Chemical Formula B-1:

[Chemical Formula A-1]

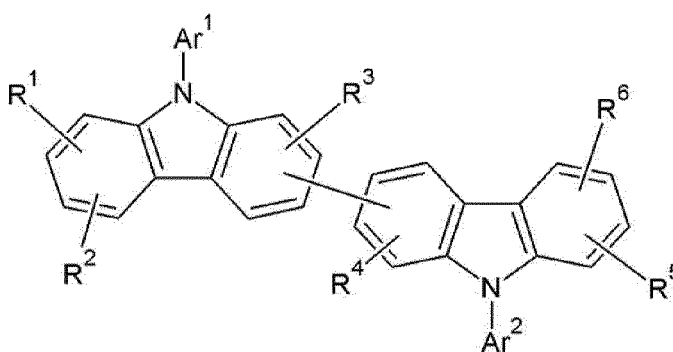

wherein, in Chemical Formula A-1,

Ar¹ is a substituted or unsubstituted pyridinyl group,

Ar² is hydrogen, deuterium, a C1 to C30 alkyl group, a C6 to C30 aryl group, or a substituted or unsubstituted pyrimidinyl group, and

R¹ to R⁶ are the same or different and independently hydrogen, deuterium, a C1 to C30 alkyl group, a C6 to C30 aryl group, or a combination thereof,

[Chemical Formula B-1]

5

10

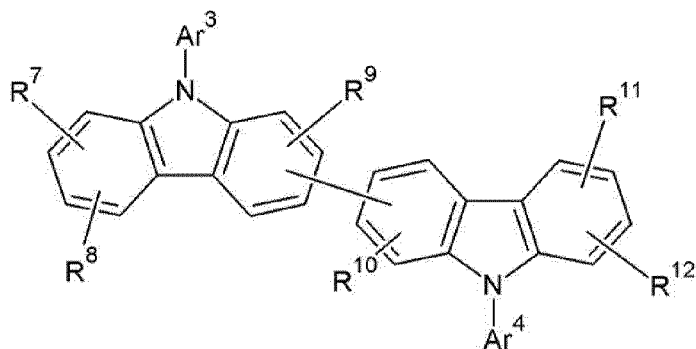

15

wherein, in Chemical Formula B-1,

Ar³ is a substituted or unsubstituted heteroaryl group including at least two nitrogen,

Ar⁴ is hydrogen, deuterium, a C1 to C30 alkyl group, C6 to C30 aryl group, or a substituted or unsubstituted heteroaryl group including at least two nitrogen, and

R⁷ to R¹² are the same or different and independently hydrogen, deuterium, a C1 to C30 alkyl group, a C6 to C30 aryl group, or a combination thereof.

20

2. The organic material for an organic optoelectronic device of claim 1, wherein the at least one compound represented by the following Chemical Formula A-1 is represented by the following Chemical Formula A-2, and the at least one compound represented by the following Chemical Formula B-1 is represented by the following Chemical Formula B-2:

25

[Chemical Formula A-2]

30

35

40

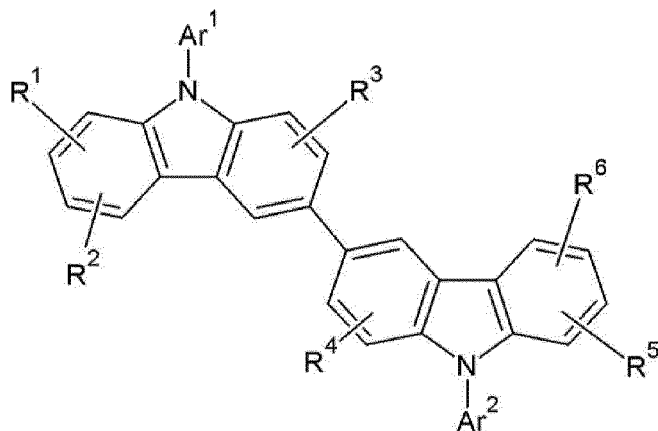

45

wherein, in Chemical Formula A-2,

Ar¹ is a substituted or unsubstituted pyridinyl group,

Ar² is hydrogen, deuterium, a C1 to C30 alkyl group, a C6 to C30 aryl group, or a substituted or unsubstituted pyrimidyl group, and

R¹ to R⁶ are the same or different and independently hydrogen, deuterium, a C1 to C30 alkyl group, a C6 to C30 aryl group, or a combination thereof,

50

55

[Chemical Formula B-2]

5

10

15

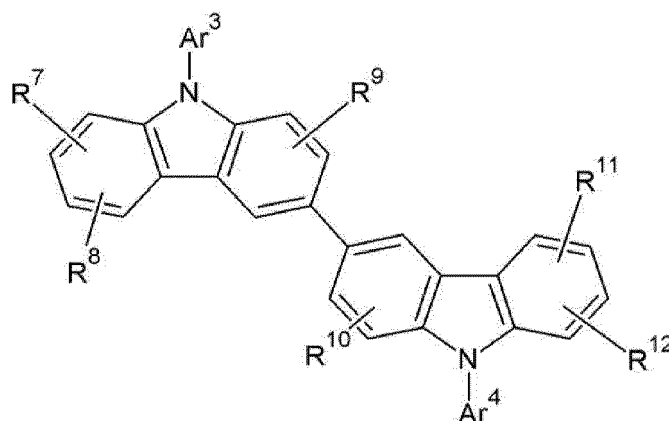

wherein, in Chemical Formula B-2,

Ar³ is a substituted or unsubstituted heteroaryl group including at least two nitrogen,

Ar⁴ is hydrogen, deuterium, a C1 to C30 alkyl group, C6 to C30 aryl group, or a substituted or unsubstituted heteroaryl group including at least two nitrogen, and

R⁷ to R¹² are the same or different and independently hydrogen, deuterium, a C1 to C30 alkyl group, a C6 to C30 aryl group, or a combination thereof.

3. The organic material for an organic optoelectronic device of claim 1, wherein the Ar³ is represented by the Chemical Formula selected from the group consisting of the following Chemical Formulas B-3, B-4, B-5, and B-6:

[Chemical Formula B-3] [Chemical Formula B-4]

30

35

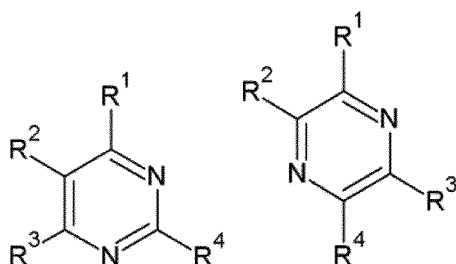

40

[Chemical Formula B-5] [Chemical Formula B-6]

45

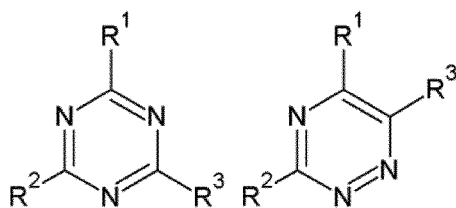

50

wherein, in Chemical Formulas B-3, B-4, B-5 and B-6,

R¹ to R⁴ are the same or different and independently hydrogen, deuterium, a C1 to C30 alkyl group, a C6 to C30 aryl group, or a combination thereof,

in Chemical Formulas B-3 and B-4,

one of R¹ to R⁴ is a single bond linked to nitrogen of the above Chemical Formula B-1, and

55

in Chemical Formulas B-5 and B-6,

one of R¹ to R³ is a single bond linked to nitrogen of the above Chemical Formula B-1.

4. The organic material for an organic optoelectronic device of claim 1, wherein the Ar² and Ar⁴ are the same or different

and independently a substituted phenyl group.

5. The organic material for an organic optoelectronic device of claim 1, wherein the Ar¹ is represented by the following Chemical Formula A-3 or Chemical Formula A-4:

[Chemical Formula A-3] [Chemical Formula A-4]

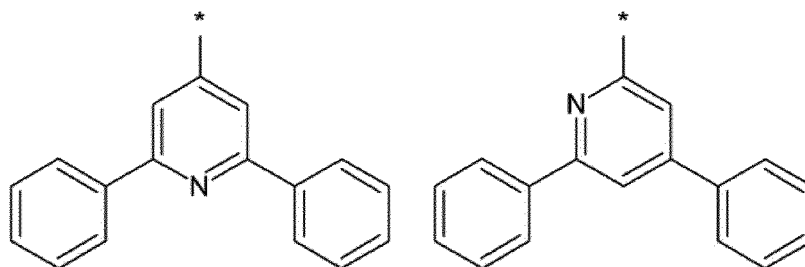

6. The organic material for an organic optoelectronic device of claim 1, wherein the Ar³ of the above Chemical Formula B-1 is a substituted or unsubstituted triazinyl or pyrimidinyl group.

7. The organic material for an organic optoelectronic device of claim 1, wherein the compound represented by the above Chemical Formula A-1 is represented by one of the following Chemical Formulas A-101 to A-118:

[Chemical Formula A-101] [Chemical Formula A-102] [Chemical Formula

A-103]

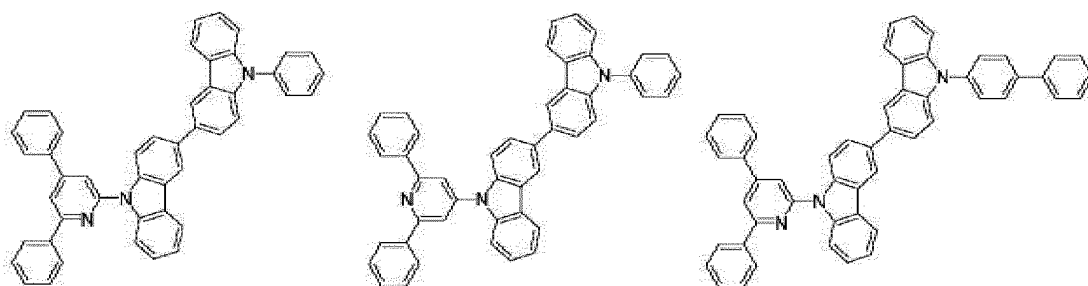

[Chemical Formula A-104] [Chemical Formula A-105] [Chemical Formula

A-106]

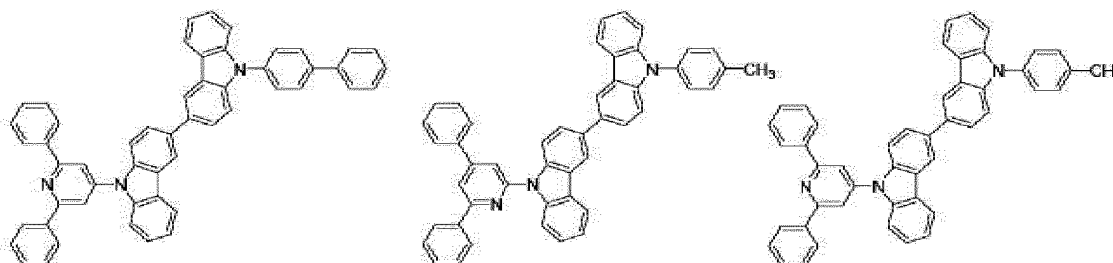

[Chemical Formula A-107] [Chemical Formula A-108] [Chemical Formula

A-109]

5

10

15

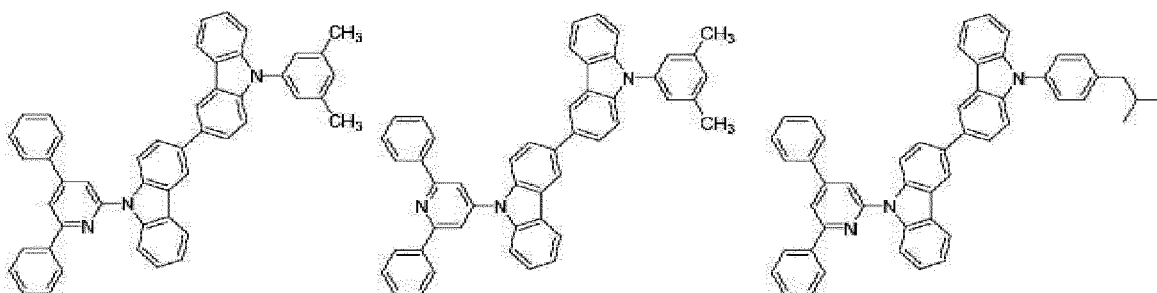

[Chemical Formula A-110] [Chemical Formula A-111] [Chemical Formula

20 A-112]

20

25

30

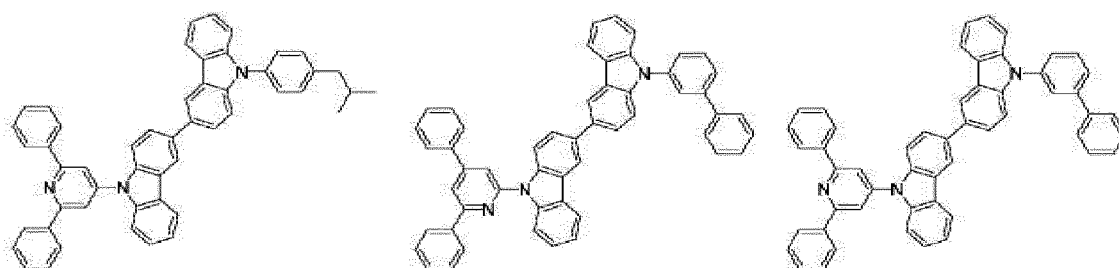

[Chemical Formula A-113] [Chemical Formula A-114] [Chemical Formula

35 A-115]

35

40

45

50

55

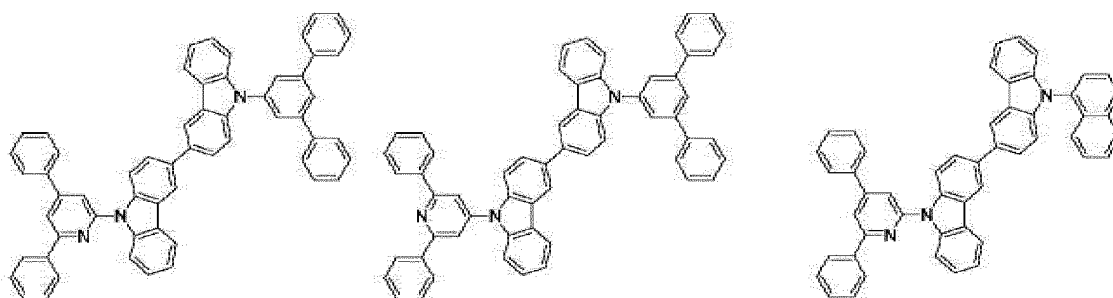

[Chemical Formula A-116] [Chemical Formula A-117] [Chemical Formula

A-118]

5

10

15

8. The organic material for an organic optoelectronic device of claim 1, wherein the compound represented by the above Chemical Formula B-1 is represented by one of the following Chemical Formulas B-101 to B-109 or B-201 to B-218:

20

[Chemical Formula B-101] [Chemical Formula B-102] [Chemical Formula

B-103]

25

30

35

[Chemical Formula B-104] [Chemical Formula B-105] [Chemical Formula

B-106]

40

45

50

[Chemical Formula B-107] [Chemical Formula B-108] [Chemical Formula

B-109]

55

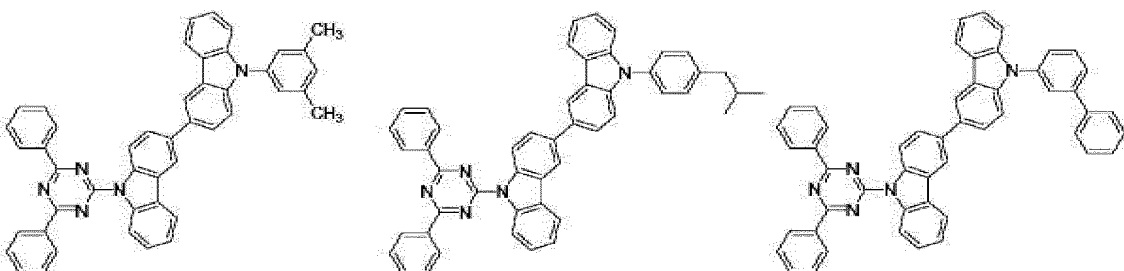
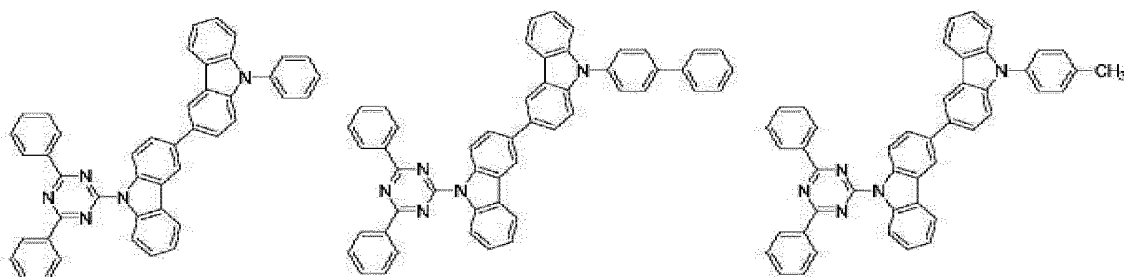
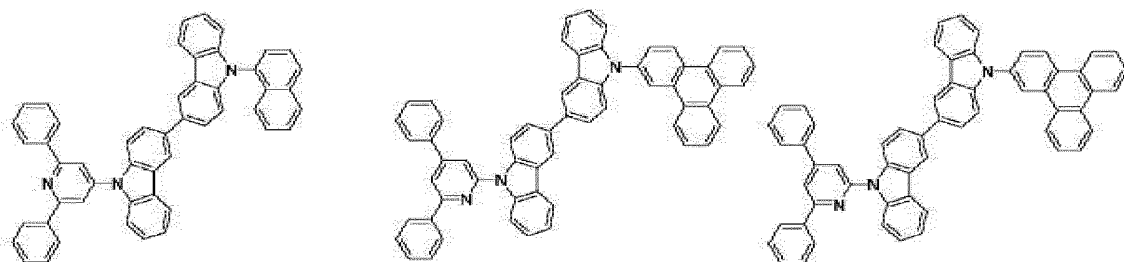

5
10

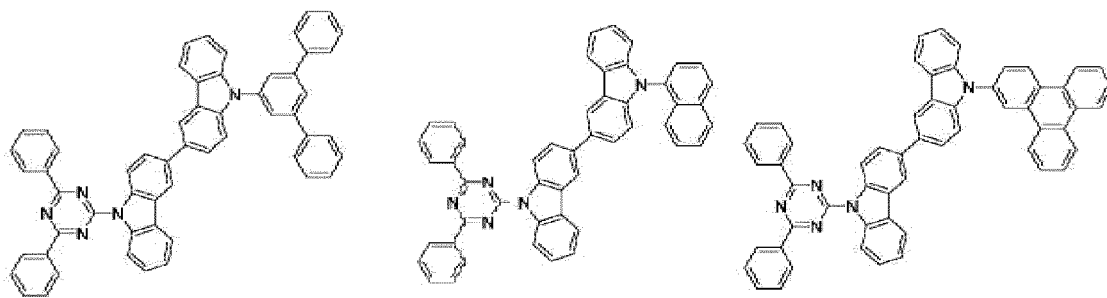

[Chemical Formula B-201] [Chemical Formula B-202] [Chemical
Formula B-203]

20
25

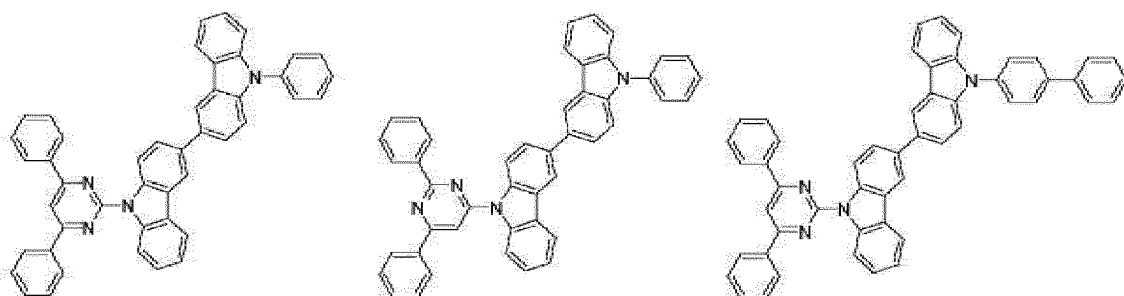

[Chemical Formula B-204] [Chemical Formula B-205] [Chemical Formula
B-206]

35
40

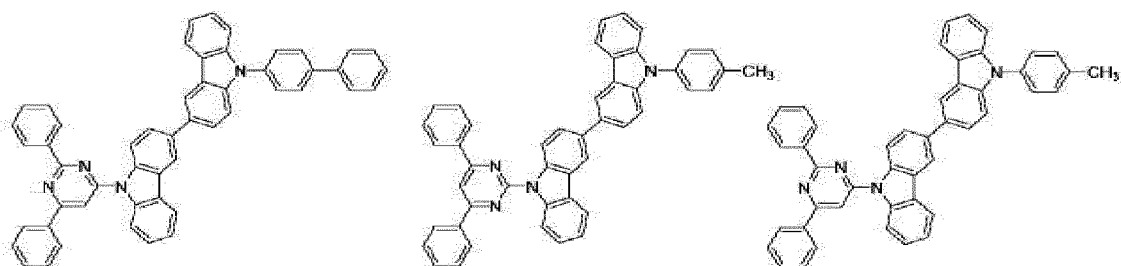

[Chemical Formula B-207] [Chemical Formula B-208] [Chemical Formula
B-209]

50
55

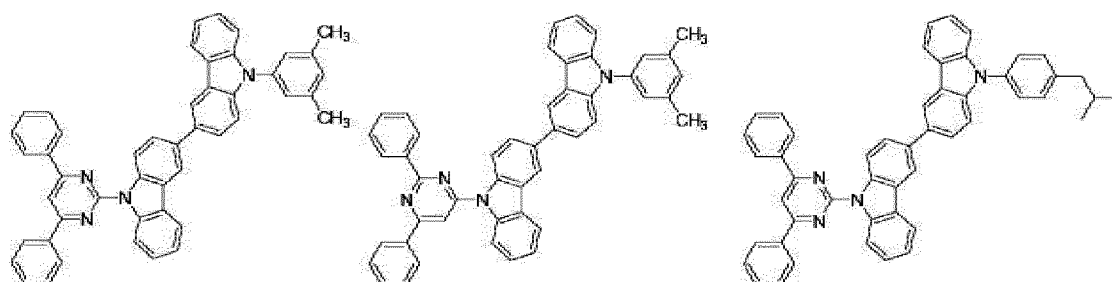

[Chemical Formula B-210] [Chemical Formula B-211] [Chemical Formula B-212]

5

10

15

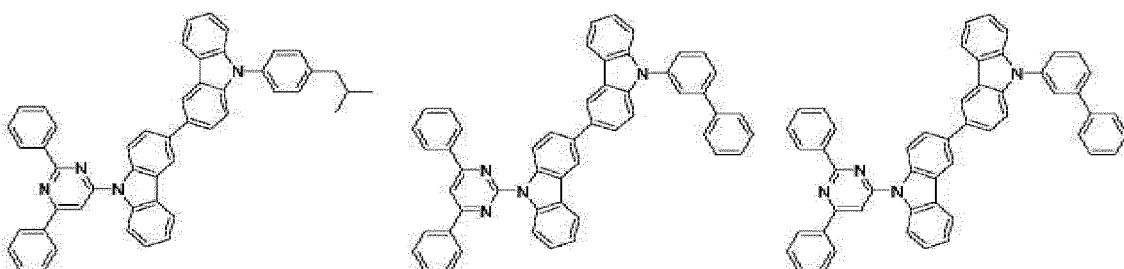

[Chemical Formula B-213] [Chemical Formula B-214] [Chemical Formula B-215]

20

25

30

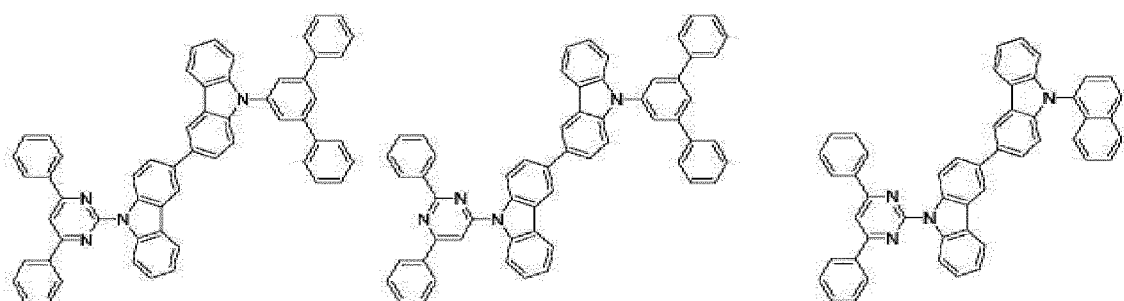

[Chemical Formula B-216] [Chemical Formula B-217] [Chemical Formula B-218]

35

40

45

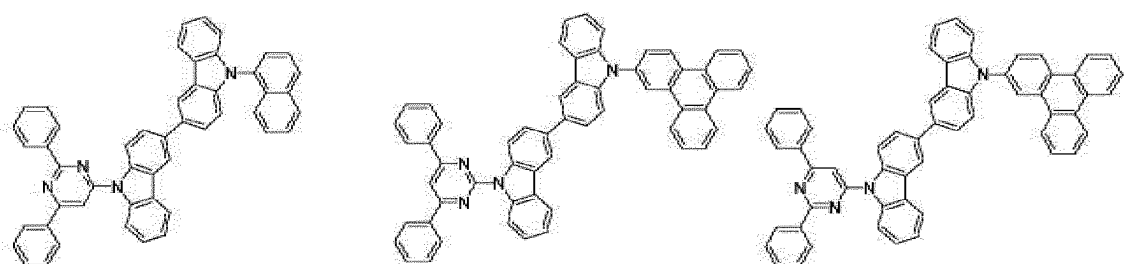

9. The organic material for an organic optoelectronic device of claim 1, wherein the compound represented by the above Chemical Formula B-1 has a LUMO energy level that is lower by 0.2eV or more than a LUMO energy level of the compound represented by the above Chemical Formula A-1.

50

10. The material for an organic optoelectronic device of claim 1, wherein the organic optoelectronic device is selected from an organic photoelectric device, an organic light emitting diode, an organic solar cell, an organic transistor, an organic photo-conductor drum, and an organic memory device.

55

11. An organic light emitting diode comprising:

an anode, a cathode, and at least one or more organic thin layer between the anode and the cathode, wherein at least one of the organic thin layer includes the material for an organic optoelectronic device according

to claim 1.

12. The organic light emitting diode of claim 11, wherein the organic thin layer is selected from an emission layer, a hole transport layer (HTL), a hole injection layer (HIL), an electron transport layer (ETL), an electron injection layer (EIL), a hole blocking layer, and a combination thereof.

13. The organic light emitting diode of claim 11, wherein the material for an organic optoelectronic device is included in a hole transport layer (HTL) or a hole injection layer (HIL).

14. The organic light emitting diode of claim 11, wherein the material for an organic optoelectronic device is included in an emission layer.

15. A display device including the organic light emitting diode, comprising the organic light emitting diode according to claim 11.

Patentansprüche

1. Material für eine organische optoelektronische Vorrichtung, mit:

mindestens einer durch die folgende chemische Formel A-1 dargestellten Verbindung und mindestens einer durch die folgende chemische Formel B-1 dargestellten Verbindung

[Chemische Formel A-1]

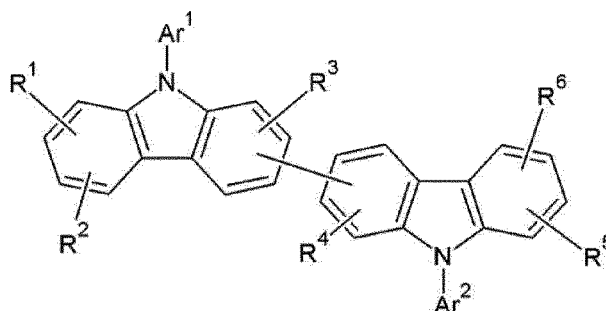

wobei in der chemischen Formel A-1

Ar¹ eine substituierte oder unsubstituierte Pyridinylgruppe ist,

Ar² Wasserstoff, Deuterium, eine C1- bis C30-Alkylgruppe, eine C6-bis C30-Arylgruppe oder eine substituierte oder unsubstituierte Pyrimidylgruppe ist, und

R¹ bis R⁶ gleich oder verschieden und unabhängig voneinander Wasserstoff, Deuterium, eine C1- bis C30-Alkylgruppe, eine C6- bis C30-Arylgruppe oder eine Kombination davon sind;

[Chemische Formel B-1]

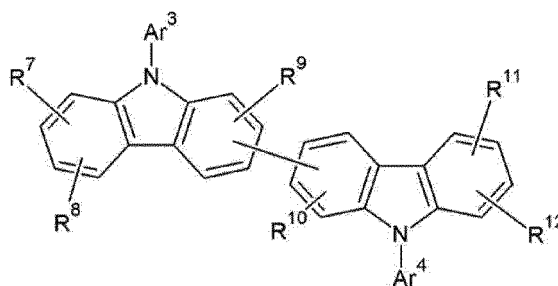

wobei in der chemischen Formel B-1 Ar³ eine substituierte oder unsubstituierte Heteroarylgruppe mit mindestens zwei Stickstoffatomen ist,

Ar⁴ Wasserstoff, Deuterium, eine C1- bis C30-Alkylgruppe, eine C6-bis C30-Arylgruppe oder eine substituierte oder unsubstituierte Heteroarylgruppe mit mindestens zwei Stickstoffatomen ist, und R⁷ bis R¹² gleich oder verschieden und unabhängig voneinander Wasserstoff, Deuterium, eine C1- bis C30-Alkylgruppe, eine C6- bis C30-Arylgruppe oder eine Kombination davon sind.

- 5
2. Organisches Material nach Anspruch 1, wobei die durch die chemische Formel A-1 dargestellte mindestens eine Verbindung durch die folgende chemische Formel A-2 dargestellt ist, und die durch die chemische Formel B-1 dargestellte mindestens eine Verbindung durch die folgende chemische Formel B-2 dargestellt ist:

[Chemische Formel A-2]

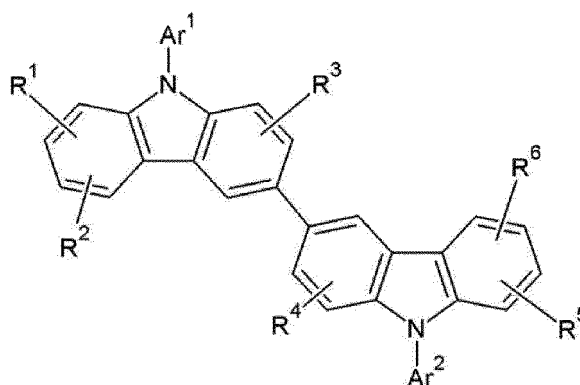

wobei in der chemischen Formel A-2 Ar¹ eine substituierte oder unsubstituierte Pyridinylgruppe ist, Ar² Wasserstoff, Deuterium, eine C1- bis C30-Alkylgruppe, ein C6- bis C30-Arylgruppe oder eine substituierte oder unsubstituierte Pyrimidinylgruppe ist, und R¹ bis R⁶ gleich oder verschieden sind und unabhängig voneinander Wasserstoff, Deuterium, eine C1- bis C30-Alkylgruppe, eine C6- bis C30-Arylgruppe oder eine Kombination davon sind,

[Chemische Formel B-2]

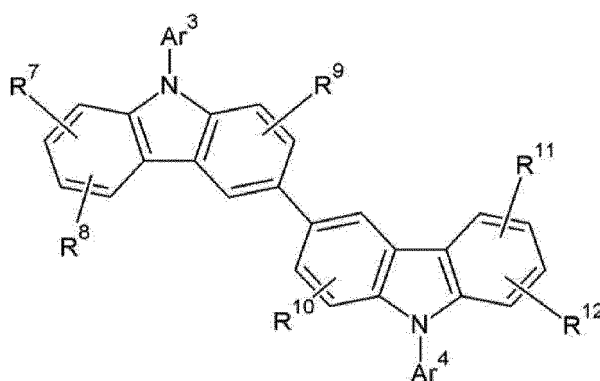

wobei in der chemischen Formel B-2 Ar³ eine substituierte oder unsubstituierte Heteroarylgruppe mit mindestens zwei Stickstoffatomen ist, Ar⁴ Wasserstoff, Deuterium, eine C1- bis C30-Alkylgruppe, eine C6-bis C30-Arylgruppe oder eine substituierte oder unsubstituierte Heteroarylgruppe mit mindestens zwei Stickstoffatomen ist, und R⁷ bis R¹² gleich oder verschieden und unabhängig voneinander Wasserstoff, Deuterium, eine C1- bis C30-Alkylgruppe, eine C6- bis C30-Arylgruppe oder eine Kombination davon sind.

- 50
55
3. Organisches Material nach Anspruch 1, wobei Ar³ durch die chemische Formel dargestellt ist, die ausgewählt ist aus der Gruppe bestehend aus den folgenden chemischen Formeln B-3, B-4, B-5 und B-6:

[Chemische Formel B-3] [Chemische Formel B-4]

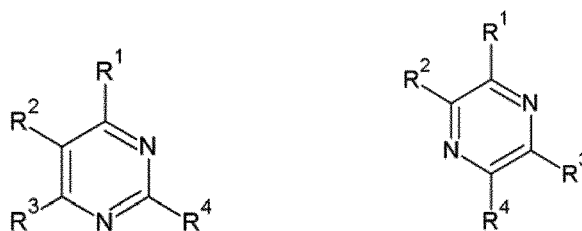

[Chemische Formel B-5] [Chemische Formel B-6]

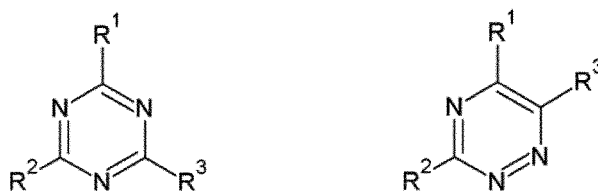

wobei in den chemischen Formeln B-3, B-4, B-5 und B-6

R¹ bis R⁴ gleich oder verschieden und unabhängig voneinander Wasserstoff, Deuterium, eine C1- bis C30-Alkylgruppe, eine C6- bis C30-Arylgruppe oder eine Kombination davon sind, in den chemischen Formeln B-3 und B-4 eine der Komponenten R¹ bis R⁴ eine Einfachbindung ist, die mit Stickstoff der vorstehenden Formel B-1 verbunden ist, und in den chemischen Formeln B-5 und B-6, eine der Komponenten R¹ bis R³ eine Einfachbindung ist, die mit Stickstoff der vorstehenden chemischen Formel B-1 verbunden ist.

4. Organisches Material nach Anspruch 1, wobei Ar² und Ar⁴ gleich oder verschieden sind und unabhängig voneinander eine substituierte Phenylgruppe sind.
5. Organisches Material nach Anspruch 1, wobei Ar¹ durch die folgende chemische Formel A-3 oder chemische Formel A-4 dargestellt ist:

[Chemische Formel A-3] [Chemische Formel A-4]

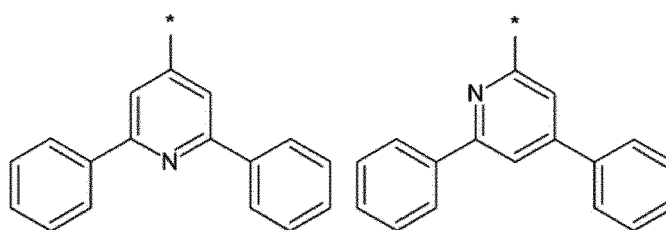

6. Organisches Material nach Anspruch 1, wobei Ar³ in der vorstehenden chemischen Formel B-1 eine substituierte oder unsubstituierte Triazinyl- oder Pyrimidinylgruppe ist.
7. Organisches Material nach Anspruch 1, wobei die durch die vorstehende chemische Formel A-1 dargestellte Verbindung durch eine der folgenden chemischen Formeln A-101 bis A-118 dargestellt ist:

[Chemische Formel A-101] [Chemische Formel A-102] [Chemische Formel A-103]

5

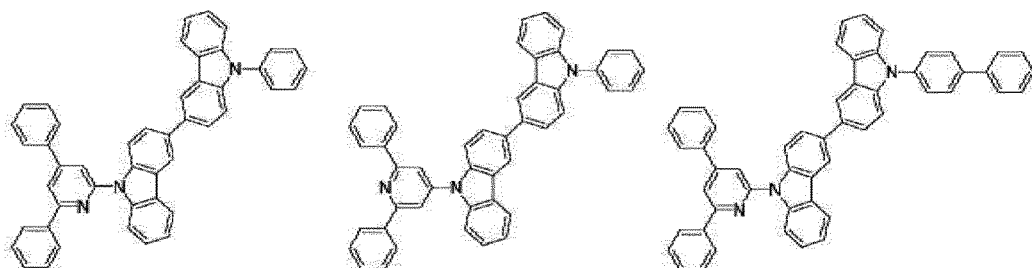

10

15

[Chemische Formel A-104] [Chemische Formel A-105] [Chemische Formel A-106]

20



25

[Chemische Formel A-107] [Chemische Formel A-108] [Chemische Formel A-109]

30

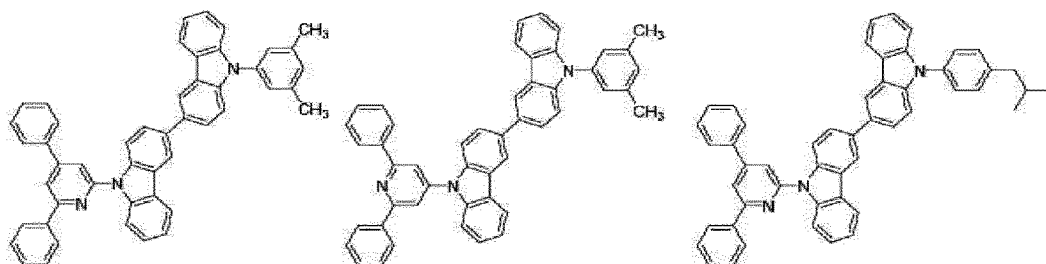

35

[Chemische Formel A-110] [Chemische Formel A-111] [Chemische Formel A-112]

40

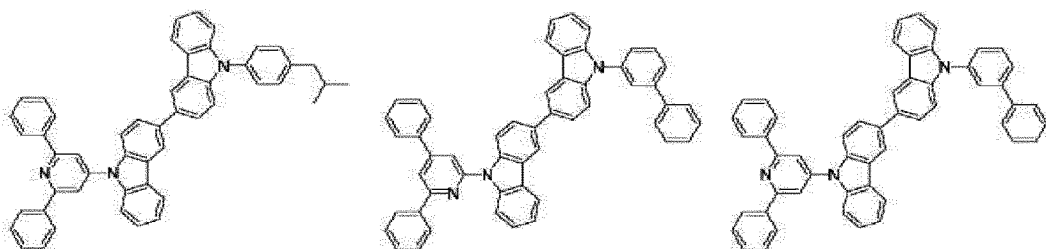

45

50

55

[Chemische Formel A-113] [Chemische Formel A-114] [Chemische Formel A-115]

5

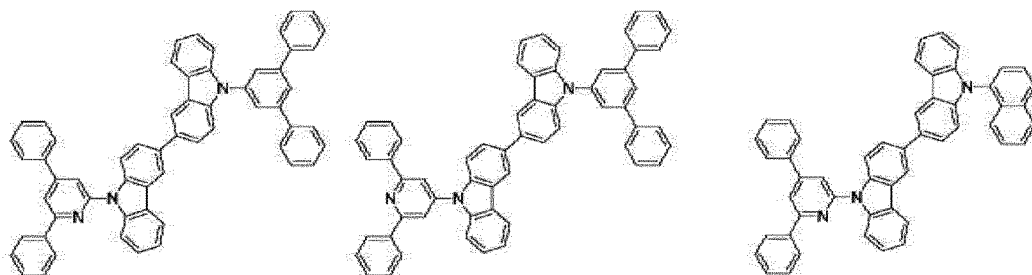

10

[Chemische Formel A-116] [Chemische Formel A-117] [Chemische Formel A-118]

15

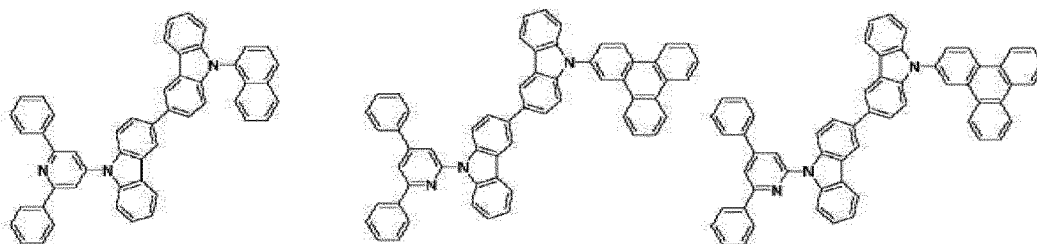

20

8. Organisches Material nach Anspruch 1, wobei die durch die vorstehende chemische Formel B-1 dargestellte Verbindung durch eine der folgenden chemischen Formeln B-101 bis B-109 oder B-201 bis B-218 dargestellt ist:

25

[Chemische Formel B-101] [Chemische Formel B-102] [Chemische Formel B-103]

30

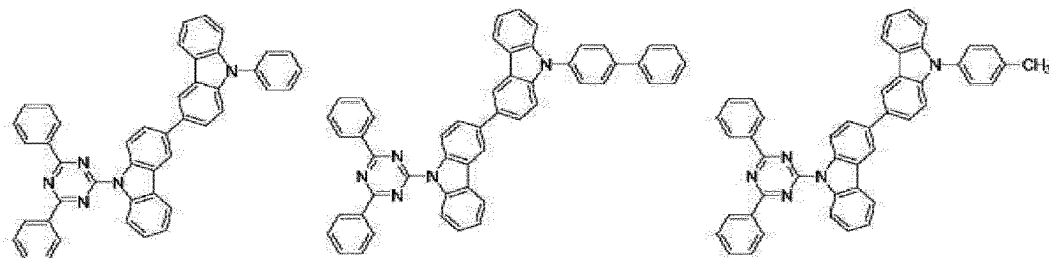

35

[Chemische Formel B-104] [Chemische Formel B-105] [Chemische Formel B-106]

40

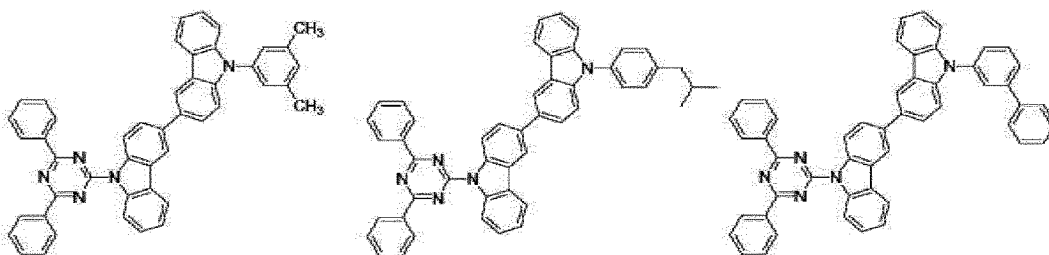

45

50

55

[Chemische Formel B-107] [Chemische Formel B-108] [Chemische Formel B-109]

5

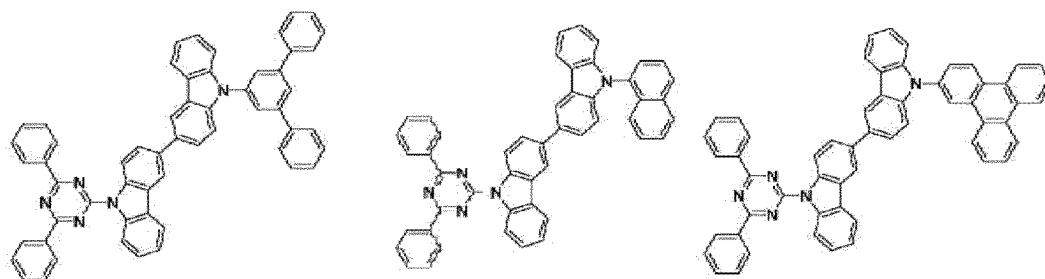

10

[Chemische Formel B-201] [Chemische Formel B-202] [Chemische Formel B-203]

15

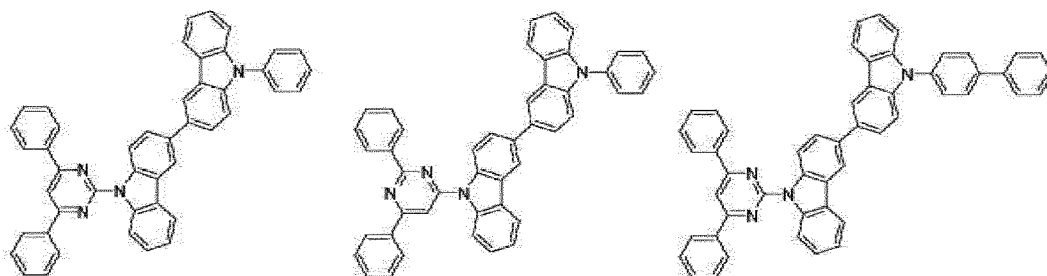

20

25

[Chemische Formel B-204] [Chemische Formel B-205] [Chemische Formel B-206]

30

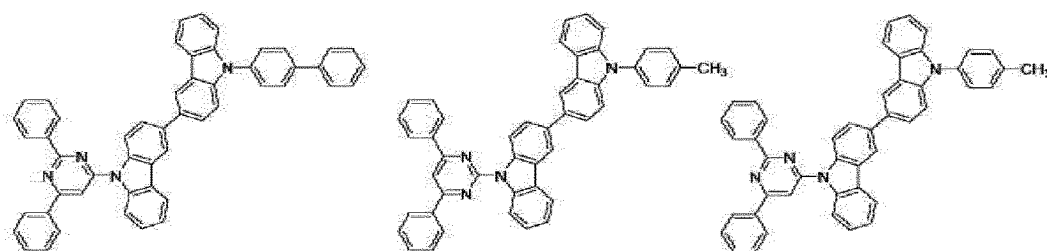

35

[Chemische Formel B-207] [Chemische Formel B-208] [Chemische Formel B-209]

40

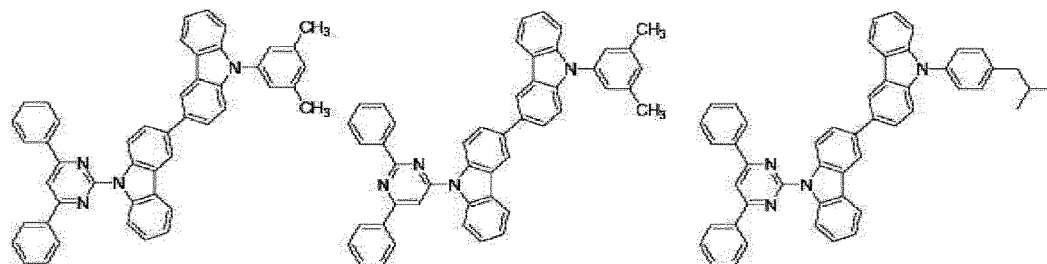

45

[Chemische Formel B-210] [Chemische Formel B-211] [Chemische Formel B-212]

50

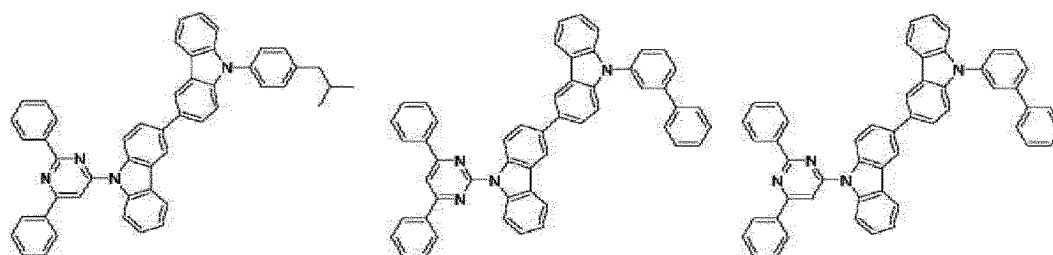

55

[Chemische Formel B-213] [Chemische Formel B-214] [Chemische Formel B-215]

5

10

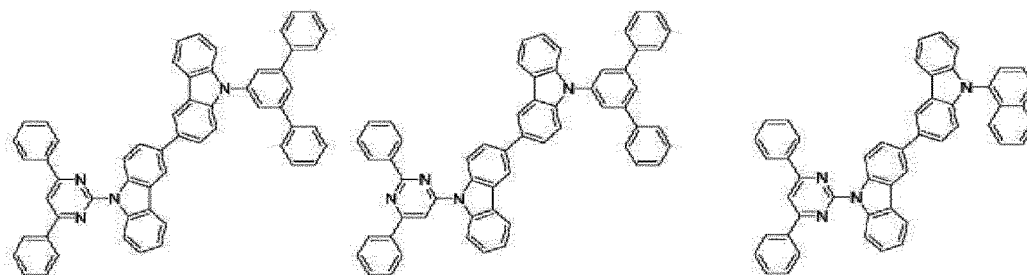

[Chemische Formel B-216] [Chemische Formel B-217] [Chemische Formel B-218]

15

20

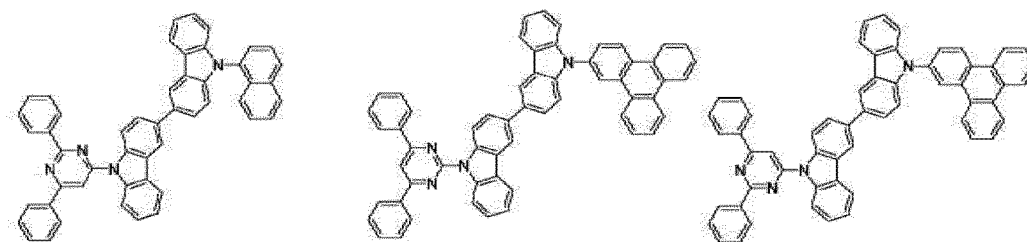

25

9. Organisches Material nach Anspruch 1, wobei die durch die vorstehende chemische Formel B-1 dargestellte Verbindung ein LUMO-Energieniveau aufweist, das um 0,2 eV oder mehr niedriger ist als ein LUMO-Energieniveau der durch die vorstehende chemische Formel A-1 dargestellten Verbindung.

30

10. Material nach Anspruch 1, wobei die organische optoelektronische Vorrichtung aus einer organischen photoelektrischen Vorrichtung, einer organischen Leuchtdiode, einer organischen Solarzelle, einem organischen Transistor, einer organischen Fotoleitertrommel und einer organischen Speichervorrichtung ausgewählt ist.

11. Organische Leuchtdiode mit:

35

einer Anode, einer Kathode und mindestens einer oder mehreren organischen Dünnschichten zwischen der Anode und der Kathode, wobei mindestens eine der organischen Dünnschichten das Material für eine organische optoelektronische Vorrichtung nach Anspruch 1 enthält.

40

12. Organische Leuchtdiode nach Anspruch 11, wobei die organische Dünnschicht ausgewählt ist aus einer Emissionsschicht, einer Lochtransportschicht (HTL), einer Lochinjektionsschicht (HIL), einer Elektronentransportschicht (ETL), einer Elektroneninjectionsschicht (EIL), einer Lochblockierschicht und einer Kombination davon.

45

13. Organische Leuchtdiode nach Anspruch 11, wobei das Material für eine organische optoelektronische Vorrichtung in einer Lochtransportschicht (HTL) oder in einer Lochinjektionsschicht (HIL) enthalten ist.

14. Organische Leuchtdiode nach Anspruch 11, wobei das Material für eine organische optoelektronische Vorrichtung in einer Emissionsschicht enthalten ist.

50

15. Anzeigevorrichtung mit der organischen Leuchtdiode nach Anspruch 11.

Revendications

55

1. Matériau pour un dispositif optoélectronique organique comprenant : au moins un composé représenté par la Formule chimique A-1 suivante ; et au moins un composé représenté par la Formule B-1 suivante :

[Formule chimique A-1]

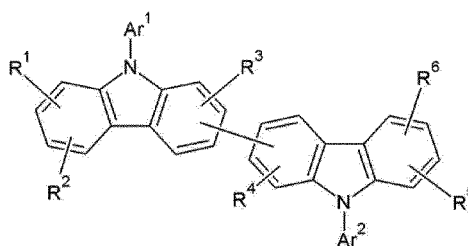

dans lequel, dans la Formule chimique A-1,

Ar¹ est un groupe pyridinyle substitué ou non substitué,

Ar² est un hydrogène, un deutérium, un groupe alkyle en C1 à C30, un groupe aryle en C6 à C30, ou un groupe pyrimidyle substitué ou non substitué, et

R¹ à R⁶ sont les mêmes ou sont différents et indépendamment, un hydrogène, un deutérium, un groupe alkyle en C1 à C30, un groupe aryle en C6 à C30 ou une combinaison de ceux-ci,

[Formule chimique B-1]

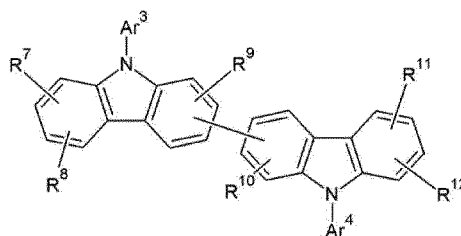

dans lequel, dans la formule chimique B-1,

Ar³ est un groupe hétéroaryle substitué ou non substitué comportant au moins deux azotes,

Ar⁴ est un hydrogène, un deutérium, un groupe alkyle en C1 à C30, un groupe aryle en C6 à C30, ou un groupe hétéroaryle substitué ou non substitué comportant au moins deux azotes, et

R⁷ à R¹² sont les mêmes ou sont différents et indépendamment, un hydrogène, un deutérium, un groupe alkyle en C1 à C30, un groupe aryle en C6 à C30 ou une combinaison de ceux-ci.

2. Matériau organique pour un dispositif optoélectronique organique selon la revendication 1, dans lequel l'au moins un composé représenté par la Formule chimique A-1 suivante est représenté par la Formule chimique A-2 suivante, et l'au moins un composé représenté par la Formule chimique B-1 suivante est représenté par la Formule chimique B-2 suivante :

[Formule chimique A-2]

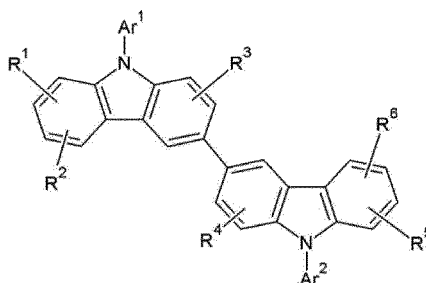

dans lequel, dans la Formule chimique A-2,

Ar¹ est un groupe pyridinyle substitué ou non substitué,

Ar² est un hydrogène, un deutérium, un groupe alkyle en C1 à C30, un groupe aryle en C6 à C30, ou un groupe pyrimidyle substitué ou non substitué, et

EP 2 675 867 B1

R¹ à R⁶ sont les mêmes ou sont différents et indépendamment, un hydrogène, un deutérium, un groupe alkyle en C1 à C30, un groupe aryle en C6 à C30 ou une combinaison de ceux-ci,

[Formule chimique B-2]

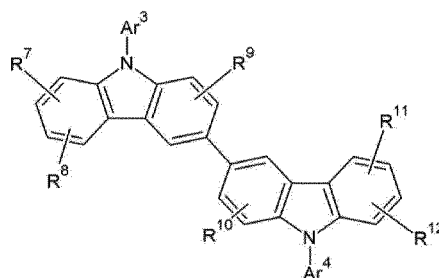

dans lequel, dans la formule chimique B-2,

Ar³ est un groupe hétéroaryle substitué ou non substitué comportant au moins deux azotes,

Ar⁴ est un hydrogène, un deutérium, un groupe alkyle en C1 à C30, un groupe aryle en C6 à C30, ou un groupe hétéroaryle substitué ou non substitué comportant au moins deux azotes, et

R⁷ à R¹² sont les mêmes ou sont différents et indépendamment, un hydrogène, un deutérium, un groupe alkyle en C1 à C30, un groupe aryle en C6 à C30 ou une combinaison de ceux-ci.

3. Matériau organique pour un dispositif optoélectronique organique selon la revendication 1, dans lequel Ar³ est représenté par la formule chimique sélectionnée dans le groupe constitué des formules chimiques B-3, B-4, B-5 et B-6 :

[Formule chimique B-3] [Formule chimique B-4]

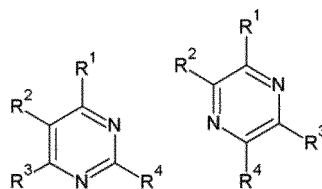

[Formule chimique B-5] [Formule chimique B-6]

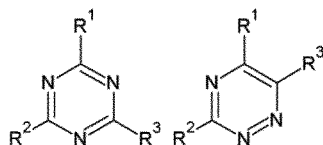

dans lequel, dans les formules chimiques B-3, B-4, B-5 et B-6

R¹ à R⁴ sont les mêmes ou sont différents et indépendamment, un hydrogène, un deutérium, un groupe alkyle en C1 à C30, un groupe aryle en C6 à C30 ou une combinaison de ceux-ci,

dans les Formules chimiques B-3 et B-4,

l'un de R¹ à R⁴ est une liaison simple liée à l'azote de la Formule chimique B-1 ci-dessus, et

dans les Formules chimiques B-5 et B-6,

l'un de R¹ à R³ est une liaison simple liée à l'azote de la Formule chimique B-1 ci-dessus.

4. Matériau organique pour un dispositif optoélectronique organique selon la revendication 1, dans lequel Ar² et Ar⁴ sont les mêmes ou sont différents et indépendamment un groupe phényle substitué.
5. Matériau organique pour un dispositif optoélectronique organique selon la revendication 1, dans lequel Ar¹ est

représenté par la Formule chimique A-3 ou la Formule chimique A-4 suivantes :

[Formule chimique A-3] [Formule chimique A-4]

5

10

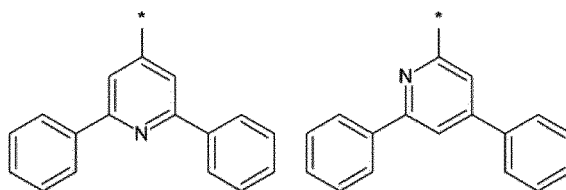

15

6. Matériau organique pour un dispositif optoélectronique organique selon la revendication 1, dans lequel Ar³ de la Formule chimique B-1 ci-dessus est un groupe triazinyle ou pyrimidinyle substitué ou non substitué.

20

7. Matériau organique pour un dispositif optoélectronique organique selon la revendication 1, dans lequel le composé représenté par la Formule chimique A-1 ci-dessus est représenté par l'une des Formules chimiques A-101 à A-118 suivantes :

[Formule chimique A-101] [Formule chimique A-102] [Formule chimique A-103]

25

30

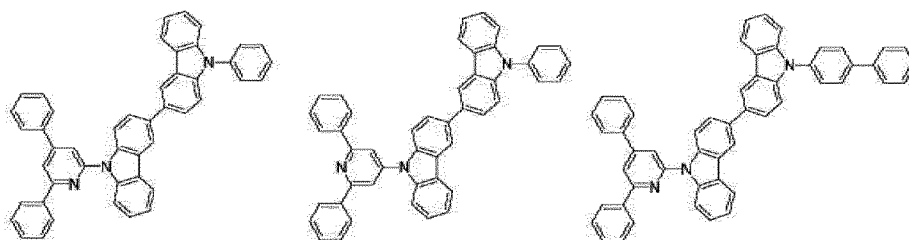

35

[Formule chimique A-104] [Formule chimique A-105] [Formule chimique A-106]

40

45

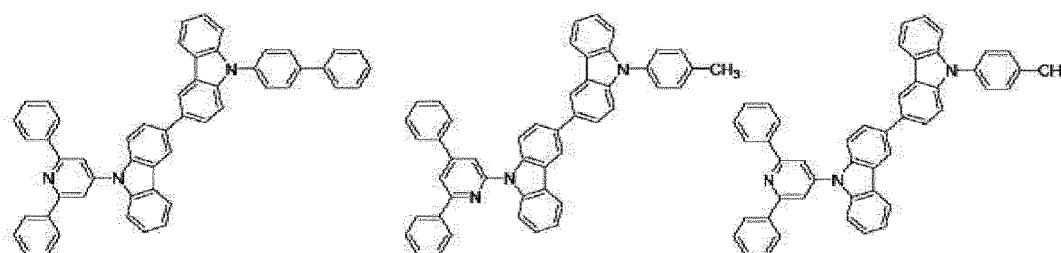

50

[Formule chimique A-107] [Formule chimique A-108] [Formule chimique A-109]

55

5

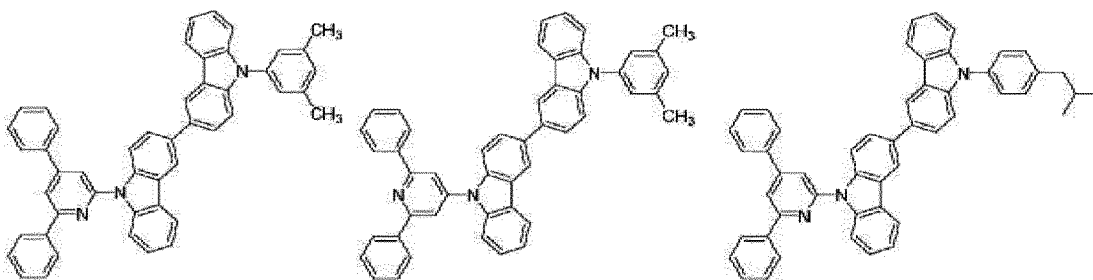

10

[Formule chimique A-110] [Formule chimique A-111] [Formule chimique A-112]

15

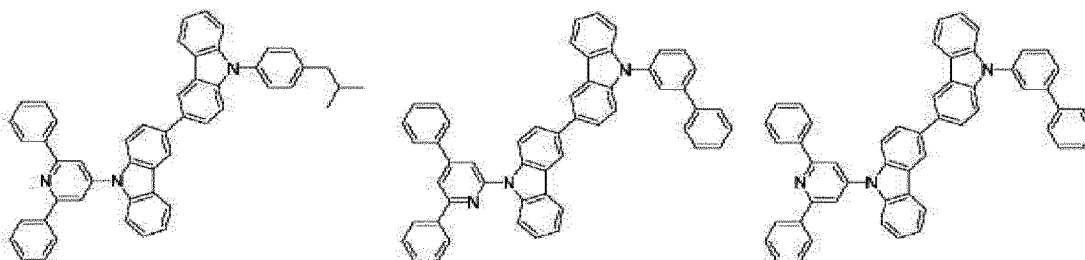

20

25

[Formule chimique A-113] [Formule chimique A-114] [Formule chimique A-115]

30

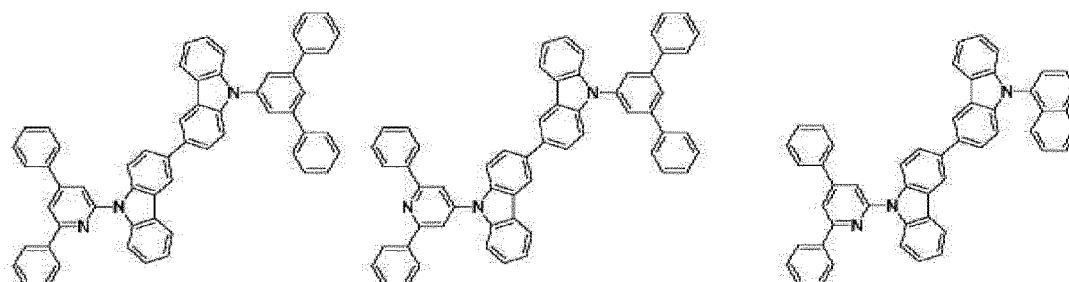

35

40

[Formule chimique A-116] [Formule chimique A-117] [Formule chimique A-118]

45

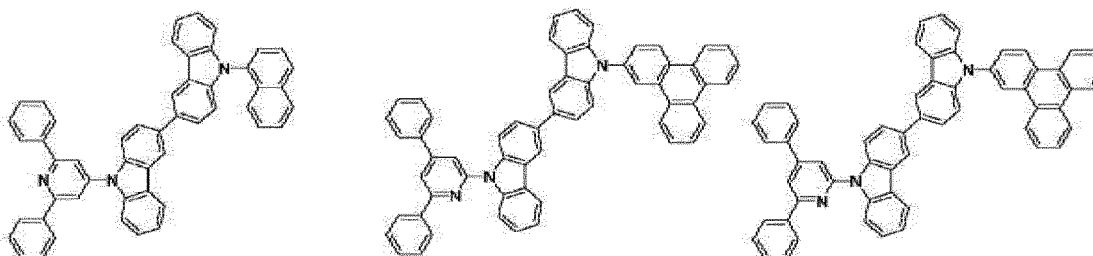

50

55

8. Matériau organique pour un dispositif optoélectronique organique selon la revendication 1, dans lequel le composé représenté par la Formule chimique B-1 est représenté par l'une des Formules chimiques B-101 à B-109 ou B-201 à B-218 suivantes :

[Formule chimique B-101] [Formule chimique B-102] [Formule chimique B-103]

5

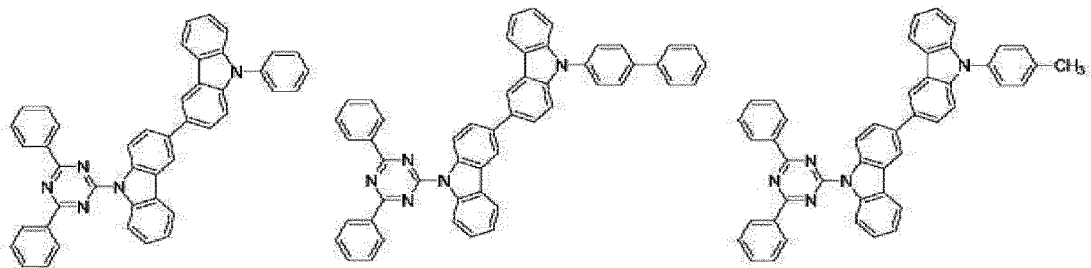

10

15

[Formule chimique B-104] [Formule chimique B-105] [Formule chimique B-106]

20

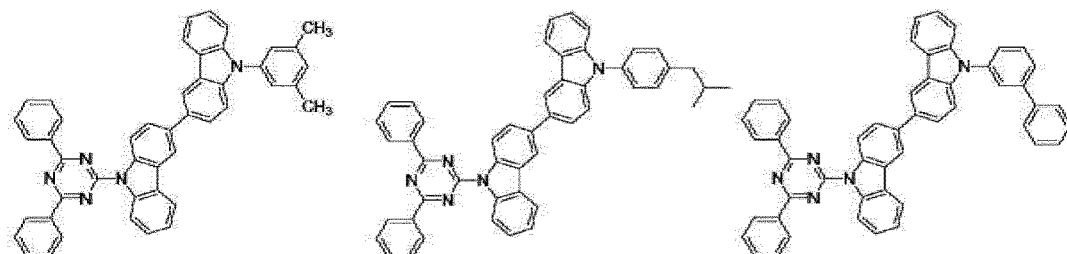

25

30

[Formule chimique B-107] [Formule chimique B-108] [Formule chimique B-109]

35

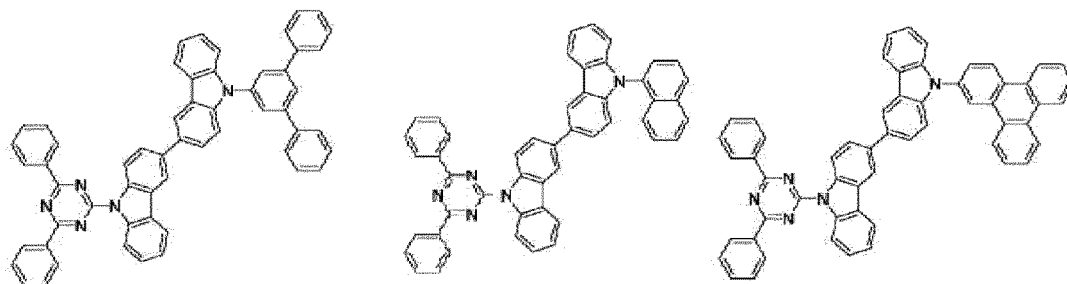

40

45

[Formule chimique B-201] [Formule chimique B-202] [Formule chimique B-203]

50

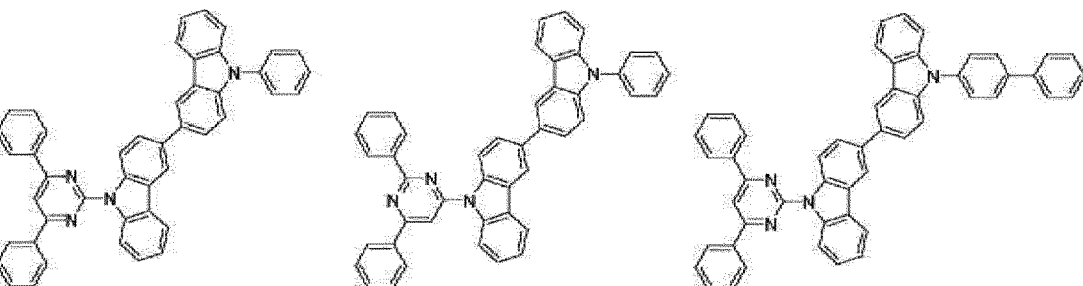

55

[Formule chimique B-204] [Formule chimique B-205] [Formule chimique B-206]

5

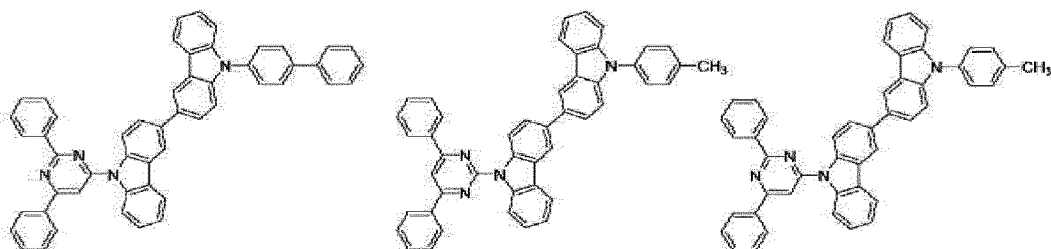

10

15

[Formule chimique B-207] [Formule chimique B-208] [Formule chimique B-209]

20

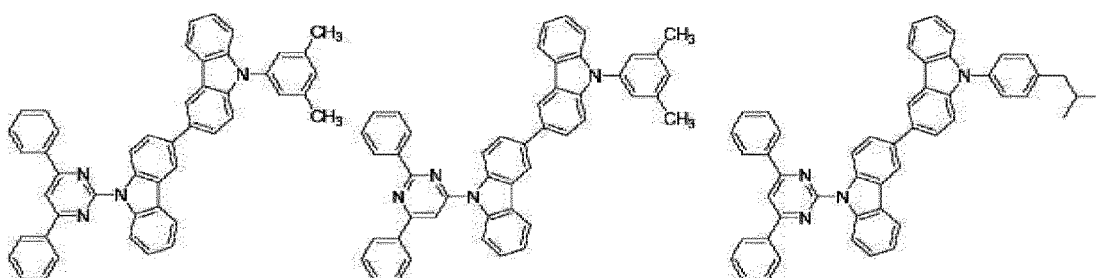

25

30

[Formule chimique B-210] [Formule chimique B-211] [Formule chimique B-212]

35

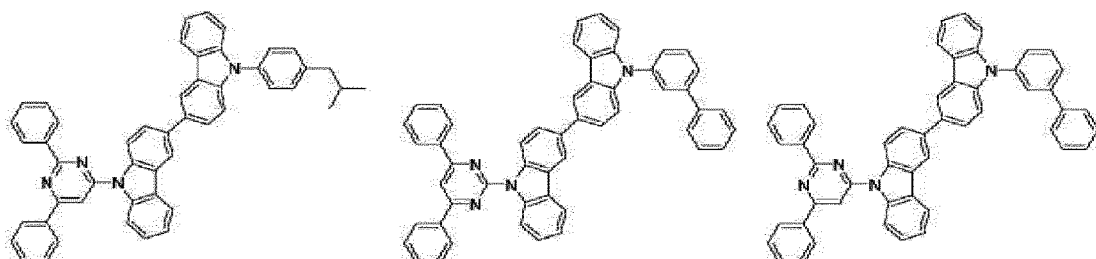

40

45

[Formule chimique B-213] [Formule chimique B-214] [Formule chimique B-215]

50

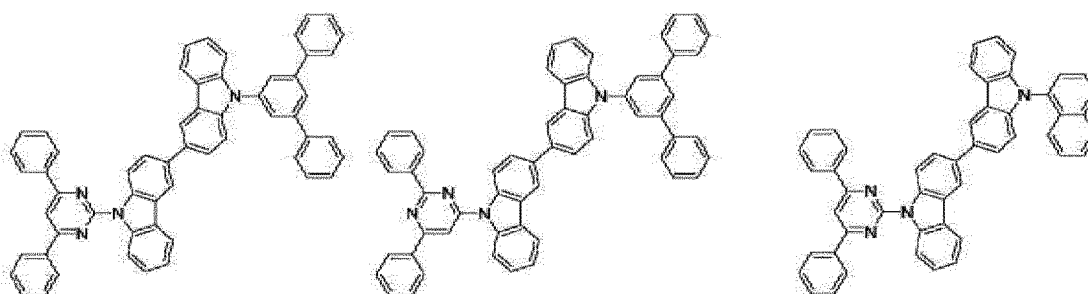

55

[Formule chimique B-216] [Formule chimique B-217] [Formule chimique B-218]

5

10

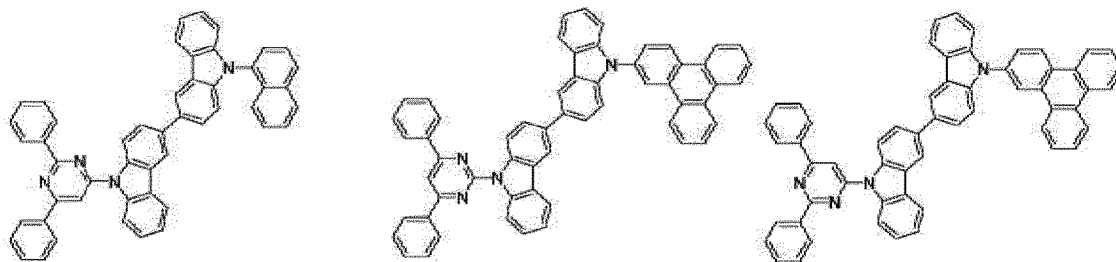

15

9. Matériau organique pour un dispositif optoélectronique organique selon la revendication 1, dans lequel le composé représenté par la Formule chimique B-1 ci-dessus a un niveau d'énergie LUMO qui est inférieur de 0,2 eV, ou plus, à un niveau d'énergie LUMO du composé représenté par la Formule chimique A-1 ci-dessus.

20

10. Matériau pour un dispositif optoélectronique organique selon la revendication 1, dans lequel le dispositif optoélectronique organique est choisi parmi un dispositif photoélectrique organique, une diode électroluminescente organique, une cellule solaire organique, un transistor organique, un tambour photoconducteur organique et un dispositif de mémoire organique.

25

11. Diode électroluminescente organique comprenant :

une anode, une cathode, et au moins une ou plusieurs couche(s) mince(s) organique(s) entre l'anode et la cathode,
dans laquelle au moins l'une des couches minces organiques inclut le matériau pour un dispositif optoélectronique organique selon la revendication 1.

30

12. Diode électroluminescente organique selon la revendication 11, dans laquelle la couche mince organique est choisie parmi une couche d'émission, une couche de transport de trou (HTL), une couche d'injection de trou (HIL), une couche de transport d'électron (ETL), une couche d'injection d'électron (EIL), une couche de blocage de trou, et une combinaison de celles-ci.

35

13. Diode électroluminescente organique selon la revendication 11, dans laquelle le matériau pour un dispositif optoélectronique organique est inclus dans une couche de transport de trou (HTL) ou une couche d'injection de trou (HIL).

40

14. Diode électroluminescente organique selon la revendication 11, dans laquelle le matériau pour un dispositif optoélectronique organique est inclus dans une couche d'émission.

45

15. Dispositif d'affichage comportant la diode électroluminescente organique comprenant la diode électroluminescente organique selon la revendication 11.

50

55

FIG.1

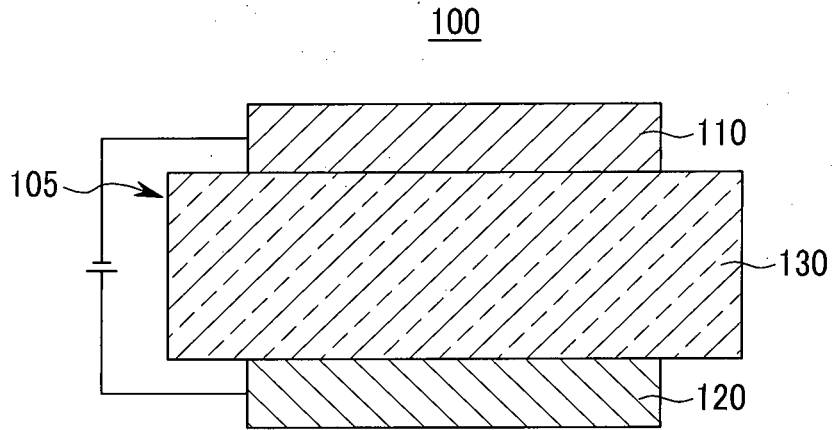

FIG.2

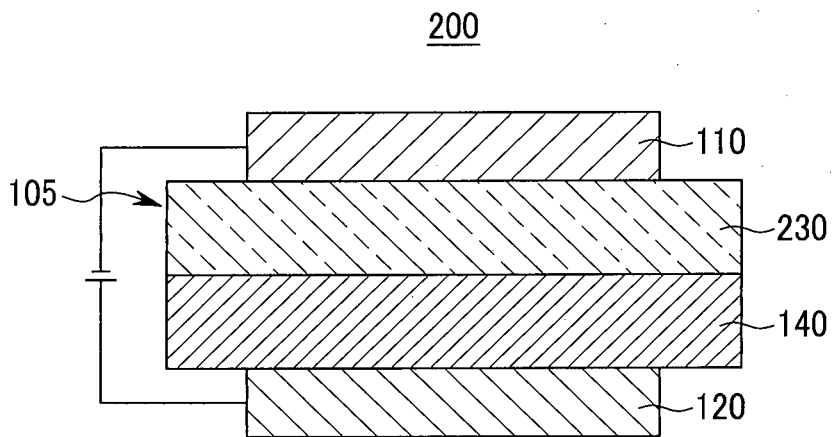

FIG.3

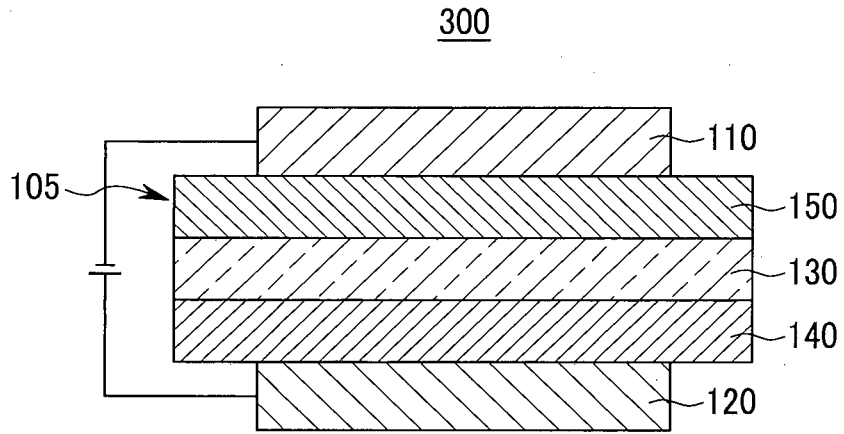

FIG.4

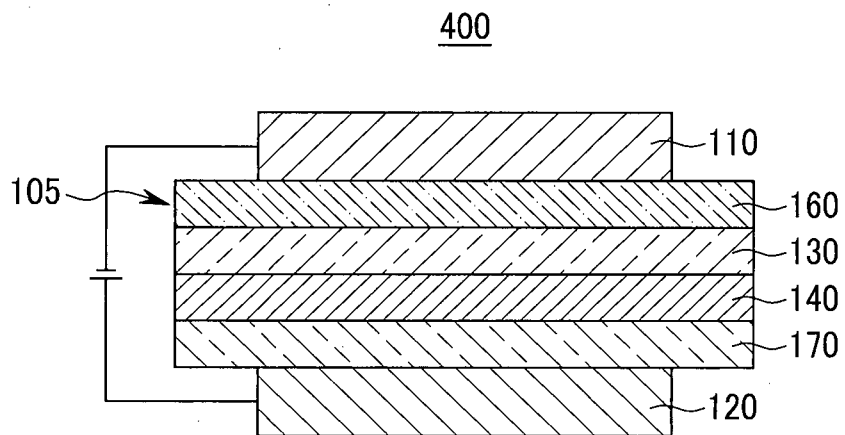

FIG.5

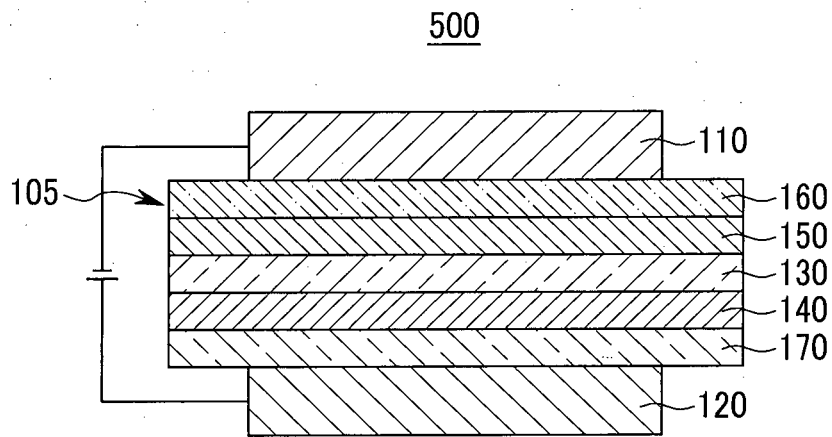

FIG.6

life-span 3000nit

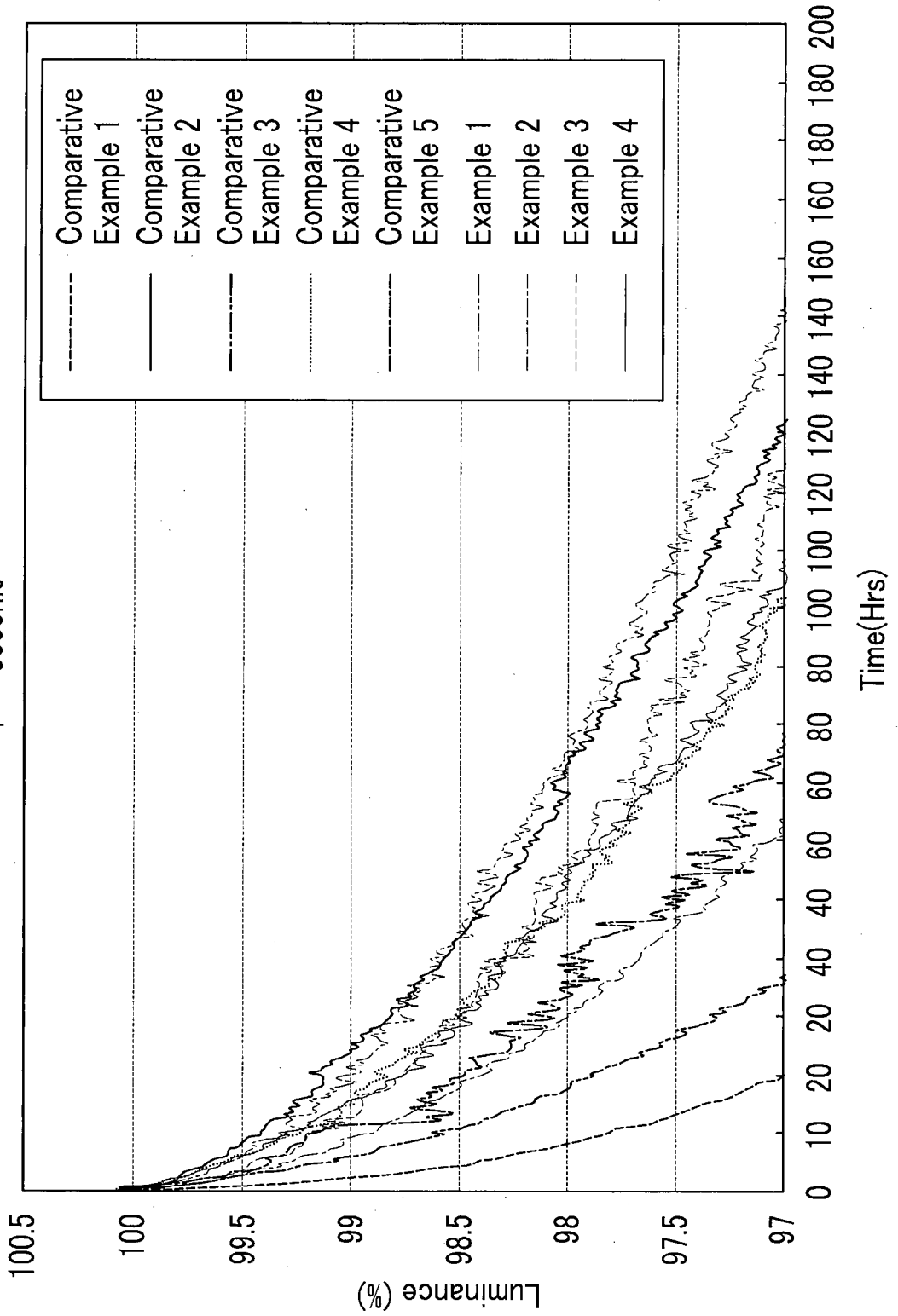

FIG.7

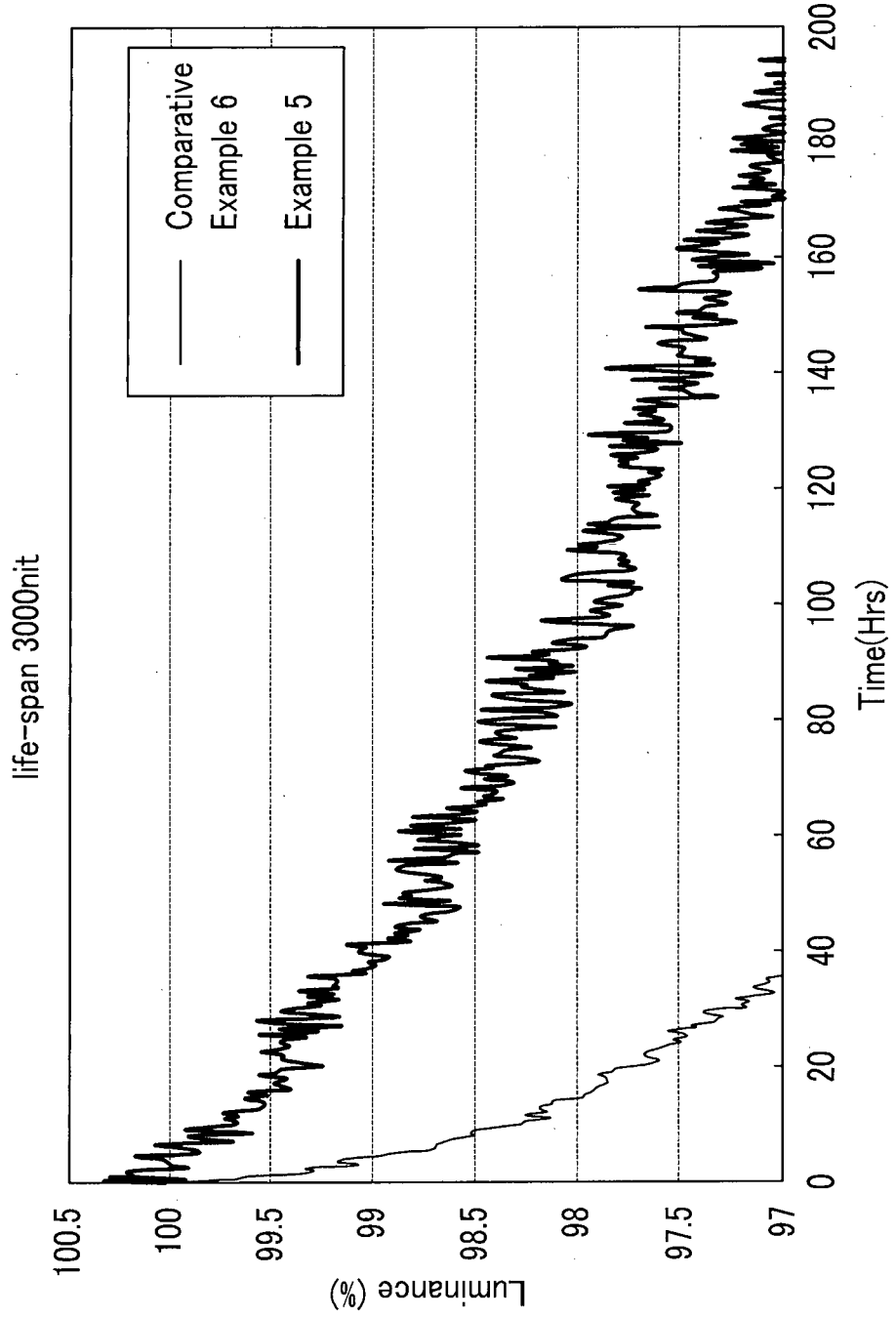

FIG.8

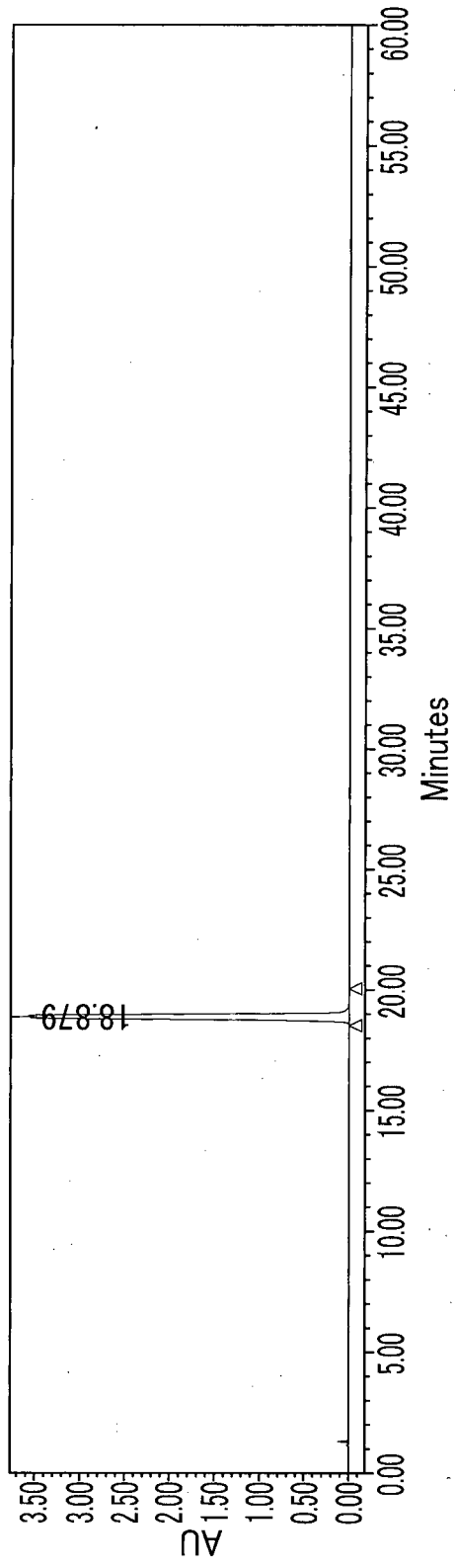

FIG.9

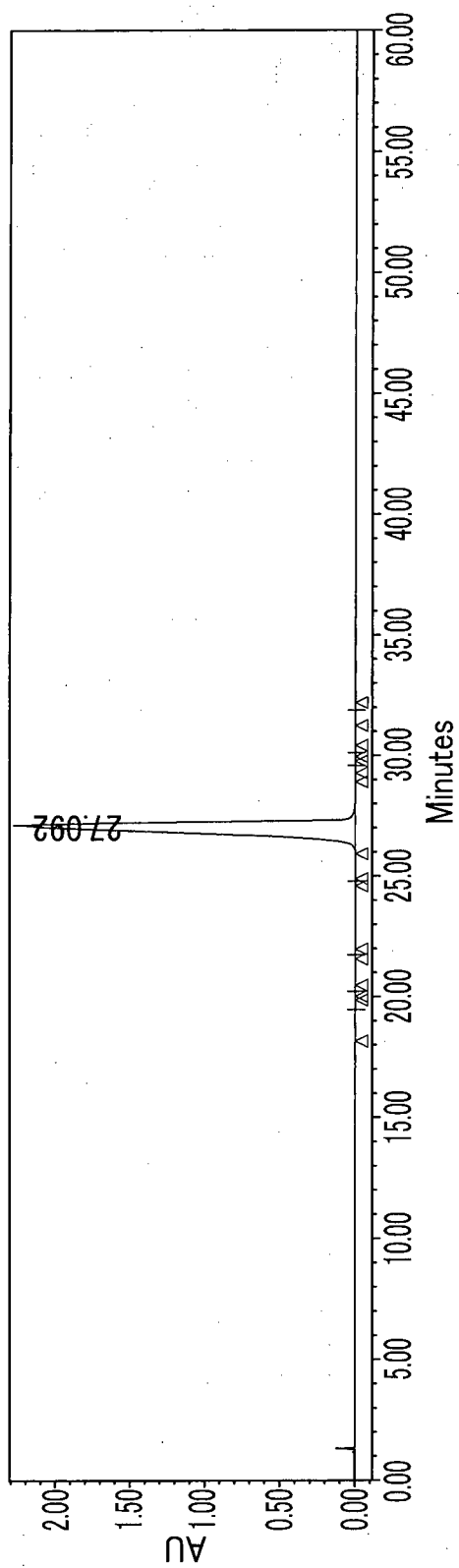
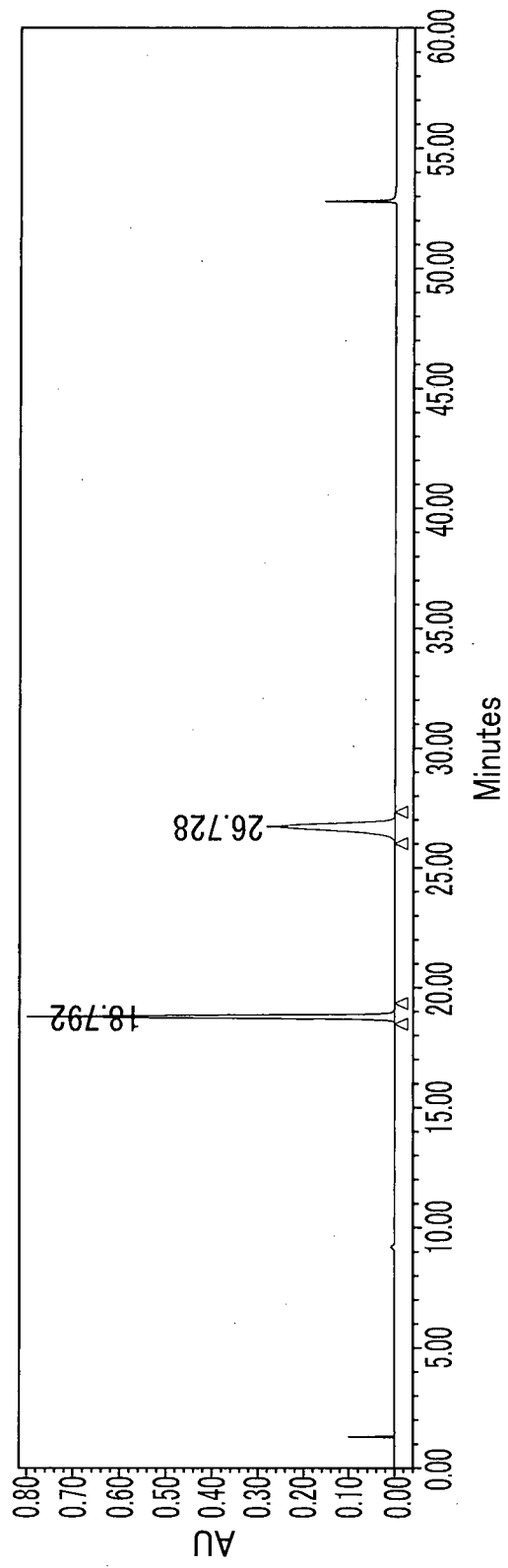

FIG.10



REFERENCES CITED IN THE DESCRIPTION

This list of references cited by the applicant is for the reader's convenience only. It does not form part of the European patent document. Even though great care has been taken in compiling the references, errors or omissions cannot be excluded and the EPO disclaims all liability in this regard.

Patent documents cited in the description

- KR 1020110015836 [0019]
- WO 2011055934 A [0019]
- WO 2011024451 A [0019]
- JP 2003133075 A [0019]
- JP 8003547 A [0019]

专利名称(译)	用于有机光电器件的材料，包括其的有机发光二极管和包括有机发光二极管的显示器		
公开(公告)号	EP2675867B1	公开(公告)日	2018-05-09
申请号	EP2011868334	申请日	2011-09-29
[标]申请(专利权)人(译)	第一毛织株式会社		
申请(专利权)人(译)	第一毛织INC.		
当前申请(专利权)人(译)	第一毛织INC.		
[标]发明人	YU EUN SUN KANG EUI SU LEE NAM HEON CHAE MI YOUNG		
发明人	YU, EUN-SUN KANG, EUI-SU LEE, NAM-HEON CHAE, MI-YOUNG		
IPC分类号	C09K11/06 H01L51/54		
CPC分类号	C09B57/00 C09B57/008 C09K2211/1007 C09K2211/1011 C09K2211/1014 C09K2211/1029 C09K2211/1044 C09K2211/1059 H01L51/006 H01L51/0067 H01L51/0072 H01L51/0081 H01L51/0085 H01L51/5016 H01L2251/5384 H05B33/14 Y02E10/549 H01L51/5012		
优先权	1020110059835 2011-06-20 KR		
其他公开文献	EP2675867A4 EP2675867A1		
外部链接	Espacenet		

摘要(译)

一种用于有机光电子器件的材料，包括该材料的有机发光二极管，以及包括该有机发光二极管的显示装置，该材料包括至少一种由以下化学式A-1表示的化合物；和至少一种由以下化学式B-1表示的化合物：

