



(11) **EP 2 378 509 A1**

(12) **EUROPEAN PATENT APPLICATION**
published in accordance with Art. 153(4) EPC

(43) Date of publication:
19.10.2011 Bulletin 2011/42

(21) Application number: **09834499.7**

(22) Date of filing: **25.12.2009**

(51) Int Cl.:
G09G 3/36 (2006.01) **G02F 1/133** (2006.01)
G02F 1/1343 (2006.01) **G09G 3/20** (2006.01)
G09G 5/02 (2006.01) **H04N 9/30** (2006.01)

(86) International application number:
PCT/JP2009/007233

(87) International publication number:
WO 2010/073693 (01.07.2010 Gazette 2010/26)

(84) Designated Contracting States:
AT BE BG CH CY CZ DE DK EE ES FI FR GB GR HR HU IE IS IT LI LT LU LV MC MK MT NL NO PL PT RO SE SI SK SM TR

(30) Priority: **26.12.2008 JP 2008335246**
01.06.2009 JP 2009132500

(71) Applicant: **Sharp Kabushiki Kaisha**
Osaka-shi, Osaka 545-8522 (JP)

(72) Inventors:
• **MORI, Tomohiko**
Osaka-shi, Osaka 545-8522 (JP)
• **TOMIZAWA, Kazunari**
Osaka-shi, Osaka 545-8522 (JP)
• **YOSHIDA, Yuichi**
Osaka-shi, Osaka 545-8522 (JP)

(74) Representative: **Goddard, Heinz J.**
Forrester & Boehmert
Pettenkofenstrasse 20-22
80336 München (DE)

(54) **LIQUID CRYSTAL DISPLAY DEVICE**

(57) A liquid crystal display device (**100**) according to the present invention includes pixels (**P1**) and (**P2**), each of which includes three subpixels (**R1**, **G1**, **B1**) and (**R2**, **G2**, **B2**). When the input signal indicates that a chromatic color should be represented, one of the subpixels (**B1** and **B2**) is turned ON and at least one of the subpixels (**R1**, **R2**, **G1** and **G2**) is turned ON, too. If the average luminance of the subpixels (**B1** and **B2**) in a situation where the input signal indicates that the chromatic color should be represented is substantially equal to that of the subpixels (**B1** and **B2**) in another situation where the input signal indicates that an achromatic color should be represented, the luminances of those subpixels (**B1** and **B2**) in the former situation are different from those of the subpixels (**B1** and **B2**) in the latter situation.

FIG. 4

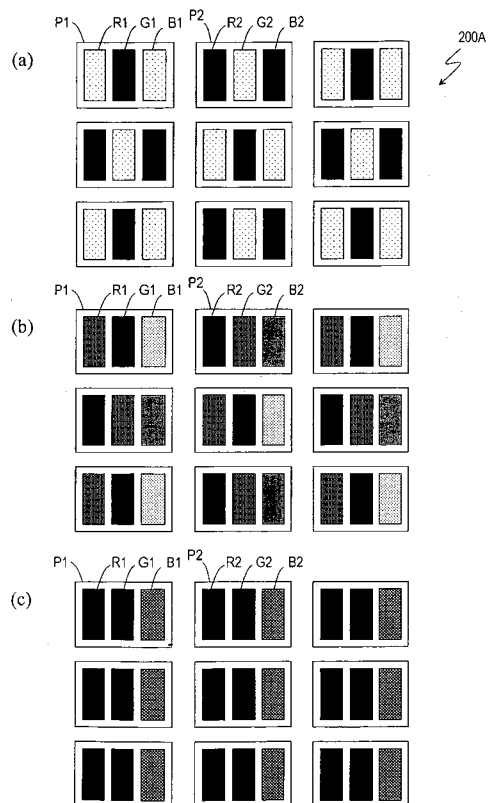

Description**TECHNICAL FIELD**

5 [0001] The present invention relates to a liquid crystal display device.

BACKGROUND ART

10 [0002] Liquid crystal displays (LCDs) have been used in not only TV sets with a big screen but also small display devices such as the monitor screen of a cellphone. In an LCD, one pixel consists of three subpixels representing red (R), green (G) and blue (B) that are the three primary colors of light, and the difference in color between those red, green and blue subpixels is typically produced by color filters.

15 [0003] TN (twisted nematic) mode LCDs, which would often be used in the past, achieved relatively narrow viewing angles, but LCDs of various other modes with wider viewing angles have recently been developed one after another. Examples of those wider viewing angle modes include IPS (in-plane switching) mode and VA (vertical alignment) mode. Among those wide viewing angle modes, the VA mode is adopted in a lot of LCDs because the VA mode would achieve a sufficiently high contrast ratio.

20 [0004] When viewed obliquely, however, the VA mode LCD sometimes produces grayscale inversion. Thus, to minimize such grayscale inversion, an MVA (multi-domain vertical alignment) mode in which multiple liquid crystal domains are defined within a single pixel region is adopted. In an MVA mode LCD, an alignment control structure is provided for at least one of the two substrates, which face each other with a vertical alignment liquid crystal layer interposed between them, so that the alignment control structure contacts with the liquid crystal layer. As the alignment control structure, a linear slit (opening) of an electrode or a rib (projection) may be used, thereby applying anchoring force to the liquid crystal layer from one or both sides thereof. In this manner, multiple (typically four) liquid crystal domains with multiple
25 different alignment directions are defined, thereby minimizing the grayscale inversion.

30 [0005] Also known as another kind of VA mode is a CPA (continuous pinwheel alignment) mode. In a normal CPA mode LCD, its subpixel electrodes have a highly symmetric shape and either an opening or a projection (which is sometimes called a "rivet") is arranged on the surface of the counter substrate in contact with the liquid crystal layer so as to be aligned with the center of a liquid crystal domain. When a voltage is applied, an oblique electric field is generated by the counter electrode and the highly symmetric subpixel electrode and induces radially tilted alignments of liquid crystal molecules. Also, with a rivet provided, the alignment control force of the slope of the rivet stabilizes the tilted alignments of the liquid crystal molecules. As the liquid crystal molecules are radially aligned within a single subpixel in this manner, the grayscale inversion can be minimized.

35 [0006] However, when viewed obliquely, the image displayed on a VA mode LCD will look more whitish as a whole than when viewed straight on (see Patent Document No. 1), which is called a "whitening" phenomenon. In the LCD disclosed in Patent Document No. 1, each subpixel, representing an associated one of the three primary colors of red, green and blue, has multiple regions with mutually different luminances, thereby reducing such a whitening phenomenon when the screen is viewed obliquely and improving the viewing angle characteristic. More specifically, in the LCD disclosed in Patent Document No. 1, electrodes provided for those regions of each subpixel are connected to mutually
40 different data lines (source bus lines) by way of respectively different TFTs. The LCD of Patent Document No. 1 makes the potentials at the electrodes provided for those regions of each subpixel different from each other, thereby making those regions of each subpixel have different luminances and attempting to improve the viewing angle characteristic.

45 [0007] Also, even in a situation where an achromatic color is being displayed at a middle grayscale, the chromaticity may also look different depending on whether the screen is viewed straight on or obliquely (see Patent Document No. 2, for example). In the LCD disclosed in Patent Document No. 2, in a low-luminance region of each of red, green and blue subpixels, the transmittance is caused to vary in the same way as a low-grayscale level does, thereby reducing the variation in chromaticity when an achromatic color is displayed.

50 [0008] Nevertheless, to make those regions of each subpixel have mutually different luminances, fine electrodes should be provided for those regions of each subpixel, thus increasing the cost and sometimes resulting in a decreased yield. But a TN mode LCD can be made at a lower cost than a VA mode LCD. That is why somebody proposed that the viewing angle characteristic of a TN mode LCD could be improved even without providing multiple electrodes for each subpixel (see Patent Document No. 3, for example). Specifically, in the LCD disclosed in Patent Document No. 3, if two subpixels, which are two adjacent portions to receive the same input signal one after the other, have middle grayscale levels, then the viewing angle characteristic could be improved by setting the grayscale level of one of the two subpixels to be relatively high and that of the other subpixel to be relatively low, respectively. Specifically, supposing such two
55 subpixels, which receive the same input signal one after the other, have middle grayscale levels **A** and **B** and the average $(=L(A) + L(B))/2$ of their luminances **L(A)** and **L(B)** is identified by **L(X)**, a grayscale level **X** associated with that average luminance **L(X)** is obtained and then relatively high and low grayscale levels **A'** and **B'** that achieve the luminance **L(X)**

of the grayscale level **X** are obtained. In this manner, the LCD disclosed in Patent Document No. 3 corrects the grayscale levels **A** and **B** represented by the input signal into grayscale levels **A'** and **B'**, thereby attempting to improve the viewing angle characteristic without providing any such fine electrodes for each subpixel electrode.

5 **CITATION LIST**

PATENT LITERATURE

10 **[0009]**

Patent Document No. 1: Japanese Patent Application Laid-Open Publication No. 2006-209135
 Patent Document No. 2: Japanese Patent Application Laid-Open Publication No. 2007-226242
 Patent Document No. 3: PCT International Application Japanese National-Phase Publication No. 2004-525402

15 **SUMMARY OF INVENTION**

TECHNICAL PROBLEM

20 **[0010]** All of the LCDs disclosed in these Patent Document Nos. 1 to 3 attempt to improve the viewing angle characteristic. Generally speaking, however, even if the difference in chromaticity according to the viewing angle can be decreased significantly when an achromatic color is displayed, there can still be a significant difference in chromaticity depending on whether the screen is viewed obliquely or straight on, when a chromatic color is displayed. Such a difference in chromaticity according to the viewing angle is also called a "color shift". If the color shift is significant, then the display quality will decline.

25 **[0011]** It is therefore an object of the present invention to provide a liquid crystal display device that can improve the viewing angle characteristic, and minimize the color shift, when the screen is viewed obliquely.

SOLUTION TO PROBLEM

30 **[0012]** A liquid crystal device according to the present invention has multiple pixels including first and second pixels that are arranged adjacent to each other. Each of the pixels includes a number of subpixels including first, second and third subpixels. If an input signal indicates that each of the first and second pixels should represent a particular chromatic color, not only the third subpixel of at least one of the first and second pixels but also at least one of the respective first and second subpixels of the first and second pixels turn ON. If the average luminance of the respective third subpixels of the first and second pixels in one situation where the input signal indicates that each of the first and second pixels should represent the chromatic color is substantially equal to that of the respective third subpixels of the first and second pixels in another situation where the input signal indicates that each of the first and second pixels should represent an achromatic color, the luminances of the respective third subpixels of the first and second pixels in the former situation are different from those of the respective third subpixels of the first and second pixels in the latter situation.

40 **[0013]** In one preferred embodiment, the first, second and third subpixels are red, green and blue subpixels, respectively.

[0014] In another preferred embodiment, if the average luminance of the respective first subpixels of the first and second pixels in one situation where the input signal indicates that each of the first and second pixels should represent another chromatic color is equal to that of the respective first subpixels of the first and second pixels in another situation where the input signal indicates that each of the first and second pixels should represent an achromatic color, the luminances of the respective first subpixels of the first and second pixels in the former situation are different from those of the respective first subpixels of the first and second pixels in the latter situation.

50 **[0015]** In still another preferred embodiment, if the average luminance of the respective second subpixels of the first and second pixels in one situation where the input signal indicates that each of the first and second pixels should represent still another chromatic color is equal to that of the respective second subpixels of the first and second pixels in another situation where the input signal indicates that each of the first and second pixels should represent an achromatic color, the luminances of the respective second subpixels of the first and second pixels in the former situation are different from those of the respective second subpixels of the first and second pixels in the latter situation.

55 **[0016]** In yet another preferred embodiment, the liquid crystal device further includes: first, second and third subpixel electrodes that define the first, second and third subpixels, respectively; and source bus lines, which are provided for the first, second and third subpixel electrodes, respectively.

[0017] In yet another preferred embodiment, each of the first, second and third subpixels has multiple regions that are able to have mutually different luminances.

[0018] In this particular preferred embodiment, the liquid crystal device further includes: first, second and third subpixel electrodes, which define the first, second and third subpixels, respectively, and each of which has divided electrodes that define the multiple regions; source bus lines, which are provided for the first, second and third subpixel electrodes, respectively; and storage capacitor bus lines, which are provided for the respective divided electrodes of the first, second and third subpixel electrodes.

[0019] In yet another preferred embodiment, either the input signal or a signal obtained by converting the input signal indicates the respective grayscale levels of the multiple subpixels that are included in each of the multiple pixels. And the grayscale levels of the respective third subpixels of the first and second pixels, which are indicated by either the input signal or the converted signal, are corrected according to the hues of the first and second pixels that are also indicated by the input signal.

[0020] In yet another preferred embodiment, either the input signal or a signal obtained by converting the input signal indicates the respective grayscale levels of the multiple subpixels that are included in each of the multiple pixels. And the grayscale levels of the respective third subpixels of the first and second pixels, which are indicated by either the input signal or the converted signal, are corrected according to not only the hues of the first and second pixels that are also indicated by the input signal but also a difference in grayscale level between the respective third subpixels of the first and second pixels, which is also indicated by the input signal.

[0021] In yet another preferred embodiment, if the input signal indicates that the third subpixel of one of the first and second pixels has a first grayscale level and that the third subpixel of the other pixel has either the first grayscale level or a second grayscale level, which is higher than the first grayscale level, then the luminances of the respective third subpixels of the first and second pixels are different from ones that are associated with the grayscale levels indicated by either the input signal or the signal obtained by converting the input signal. If the input signal indicates that the third subpixel of the one pixel has the first grayscale level and that the third subpixel of the other pixel has a third grayscale level, which is higher than the second grayscale level, then the luminances of the respective third subpixels of the first and second pixels are substantially equal to ones that are associated with the grayscale levels indicated by either the input signal or the signal obtained by converting the input signal.

[0022] Another liquid crystal device according to the present invention includes a pixel that has a number of subpixels including first, second and third subpixels. Each of the first, second and third subpixels has a number of regions including first and second regions that are able to have mutually different luminances. If an input signal indicates that the pixel should represent a particular chromatic color, not only at least one of the first and second regions of the third subpixel but also at least one of the respective first and second regions of the first and second subpixels turn ON. If the average luminance of the first and second regions of the third subpixel in one situation where the input signal indicates that the pixel should represent the chromatic color is equal to that of the first and second regions of the third subpixel in another situation where the input signal indicates that the pixel should represent an achromatic color, the respective luminances of the first and second regions of the third subpixel in the former situation are different from those of the first and second regions of the third subpixel in the latter situation.

[0023] In one preferred embodiment, the first, second and third subpixels are red, green and blue subpixels, respectively.

[0024] In another preferred embodiment, the liquid crystal device further includes: first, second and third subpixel electrodes, which define the first, second and third subpixels, respectively, and each of which has first and second divided electrodes that define the first and second regions, respectively; and source bus lines, which are provided for the first and second divided electrodes of the first, second and third subpixel electrodes, respectively.

[0025] In still another preferred embodiment, the liquid crystal device further includes: first, second and third subpixel electrodes, which define the first, second and third subpixels, respectively, and each of which has first and second divided electrodes that define the first and second regions, respectively; source bus lines, which are provided for the first, second and third subpixel electrodes, respectively; and gate bus lines, which are provided for the respective first and second divided electrodes of the first, second and third subpixel electrodes.

[0026] Still another liquid crystal display device according to the present invention includes multiple pixels that are arranged in columns and rows to form a matrix pattern. The multiple pixels include first, second, third and fourth pixels, which are arranged in this order along either one of the columns or one of the rows. Each of the pixels has a number of subpixels including first, second and third subpixels. If an input signal indicates that each of the first and third pixels should represent a particular chromatic color, not only the third subpixel of at least one of the first and third pixels but also at least one of the respective first and second subpixels of the first and third pixels turn ON. If the average luminance of the respective third subpixels of the first and third pixels in one situation where the input signal indicates that the first and third pixels should represent the chromatic color is substantially equal to that of the respective third subpixels of the first and third pixels in another situation where the input signal indicates that the first and third pixels should represent an achromatic color, the luminances of the respective third subpixels of the first and third pixels in the former situation are different from those of the respective third subpixels of the first and third pixels in the latter situation.

[0027] In one preferred embodiment, the luminance of the respective third subpixels of the second and fourth pixels

is substantially equal to a one that is associated with a grayscale level indicated by either the input signal or a signal obtained by converting the input signal.

ADVANTAGEOUS EFFECTS OF INVENTION

[0028] The present invention provides a liquid crystal display device that can improve the viewing angle characteristic, and minimize the color shift, when the screen is viewed obliquely.

BRIEF DESCRIPTION OF DRAWINGS

[0029]

[FIG. 1] FIG. 1(a) is a schematic representation illustrating a liquid crystal display device as a first preferred embodiment of the present invention and FIG. 1(b) is a schematic representation illustrating the LCD panel of the liquid crystal display device shown in FIG. 1(a).

[FIG. 2] FIG. 2(a) is a schematic representation illustrating how respective pixels may be arranged in the liquid crystal display device shown in FIG. 1, and FIG. 2(b) is a circuit diagram illustrating the active-matrix substrate of its LCD panel.

[FIG. 3] FIG. 3 is a chromaticity diagram of the LCD panel in the liquid crystal display device shown in FIG. 1.

[FIG. 4] FIGS. 4(a), 4(b) and 4(c) are schematic representations illustrating roughly how the liquid crystal display device shown in FIG. 1 works.

[FIG. 5] FIGS. 5(a) and 5(b) are schematic representations illustrating the appearance of the LCD panel of a liquid crystal display device as Comparative Example 1 and FIG. 5(c) is a graph showing how the obliquely viewing grayscale varies with the reference grayscale level in the liquid crystal display device of Comparative Example 1.

[FIG. 6] FIGS. 6(a) and 6(b) are schematic representations illustrating the appearance of the LCD panel of a liquid crystal display device as Comparative Example 2 and FIG. 6(c) is a graph showing how the obliquely viewing grayscale varies with the reference grayscale level in the liquid crystal display device of Comparative Example 2.

[FIG. 7] FIGS. 7(a) and 7(b) are schematic representations illustrating the appearance of the LCD panel of the liquid crystal display device shown in FIG. 1 and FIG. 7(c) is a graph showing how the obliquely viewing grayscale varies with the reference grayscale level in the liquid crystal display device shown in FIG. 1.

[FIG. 8] FIG. 8 is a schematic representation illustrating a configuration for a blue correcting section in the liquid crystal display device shown in FIG. 1.

[FIG. 9] FIG. 9(a) is a graph showing the grayscale level difference and FIG. 9(b) is a graph showing the grayscale level to be input to an LCD panel.

[FIG. 10] FIG. 10(a) is a schematic representation illustrating the hue of the LCD panel of the liquid crystal display device shown in FIG. 1, and FIGS. 10(b) and 10(c) are graphs showing how the grayscale level of a blue subpixel changes in one situation and in a different situation, respectively.

[FIG. 11] FIGS. 11(a) and 11(b) are graphs showing the corrected grayscale level and a variation in obliquely viewing grayscale in a situation where the hue coefficient $H_b = 1$, and FIGS. 11(c) and 11(d) are graphs showing the corrected grayscale level and a variation in obliquely viewing grayscale in a situation where the hue coefficient $H_b = 0.5$.

[FIG. 12] FIG. 12 is a graph showing how the obliquely viewing grayscale changes with the reference grayscale level in the liquid crystal display device shown in FIG. 1.

[FIG. 13] FIG. 13(a) is a schematic representation illustrating the hue of the LCD panel of the liquid crystal display device shown in FIG. 1 in a situation where the grayscale level of a blue subpixel is corrected and FIGS. 13(b) and 13(c) are graphs showing how the grayscale level of the blue subpixel changes when the hue coefficient $H_b = 0$ and when the hue coefficient $H_b = 1$, respectively.

[FIG. 14] FIG. 14(a) is a schematic representation illustrating the hue of the LCD panel of the liquid crystal display device shown in FIG. 1 in a situation where the grayscale level of a red subpixel is corrected and FIGS. 14(b) and 14(c) are graphs showing how the grayscale level of the red subpixel changes when the hue coefficient $H_r = 0$ and when the hue coefficient $H_r = 1$, respectively.

[FIG. 15] FIG. 15(a) is a schematic representation illustrating the hue of the LCD panel of the liquid crystal display device shown in FIG. 1 in a situation where the grayscale levels of red and blue subpixels are corrected and FIGS. 15(b), 15(c), 15(d) and 15(e) are graphs showing how the grayscale levels of the red and blue subpixels change when the hue coefficients H_r and H_b are both equal to zero, when the hue coefficients H_r and H_b are zero and one, respectively, when the hue coefficients H_r and H_b are one and zero, respectively, and when the hue coefficients H_r and H_b are both equal to one.

[FIG. 16] FIG. 16 is a schematic representation showing how the luminance level changes in a situation where blue

subpixels belonging to adjacent pixels have mutually different grayscale levels in the liquid crystal display device shown in FIG. 1.

[FIG. 17] FIG. 17(a) is a schematic representation illustrating the liquid crystal display device of Comparative Example 1 and FIGS. 17(b) and 17(c) are schematic representations illustrating the liquid crystal display device of the present embodiment.

[FIG. 18] FIG. 18 is a schematic representation illustrating a configuration for a blue correcting section in a liquid crystal display device as a modified example of the first preferred embodiment.

[FIG. 19] FIGS. 19(a), 19(b) and 19(c) are schematic representations illustrating a liquid crystal display device as a modified example of the first preferred embodiment when its correcting section includes only a red correcting section, only a green correcting section, and only a blue correcting section, respectively.

[FIG. 20] FIGS. 20(a), 20(b) and 20(c) are schematic representations illustrating configurations for the LCD panel of the liquid crystal display device shown in FIG. 1.

[FIG. 21] FIG. 21 is a partial cross-sectional view schematically illustrating a cross-sectional structure of the LCD panel of the liquid crystal display device shown in FIG. 1.

[FIG. 22] FIG. 22 is a plan view schematically illustrating a region allocated to one subpixel in the LCD panel of the liquid crystal display device shown in FIG. 1.

[FIG. 23] FIGS. 23(a) and 23(b) are plan views schematically illustrating a region allocated to one subpixel in the LCD panel of the liquid crystal display device shown in FIG. 1.

[FIG. 24] FIG. 24 is a plan view schematically illustrating a region allocated to one subpixel in the LCD panel of the liquid crystal display device shown in FIG. 1.

[FIG. 25] FIG. 25 is a chromaticity diagram of the XYZ color system showing the dominant wavelengths of respective subpixels in the LCD panel of the liquid crystal display device shown in FIG. 1.

[FIG. 26] FIG. 26(a) is a schematic representation illustrating a configuration for the blue correcting section of a liquid crystal display device as a modified example of the first preferred embodiment, and FIG. 26(b) is a schematic representation illustrating a configuration for its grayscale control section.

[FIG. 27] FIGS. 27(a) and 27(b) are schematic representations illustrating two configurations for a liquid crystal display device as a modified example of the first preferred embodiment in which an independent gamma correction processing section is positioned after and before the correcting section, respectively.

[FIG. 28] FIG. 28 is a schematic representation illustrating a liquid crystal display device as a second preferred embodiment of the present invention.

[FIG. 29] FIG. 29(a) is a schematic representation illustrating how respective pixels may be arranged in the liquid crystal display device shown in FIG. 28, and FIG. 29(b) is a circuit diagram illustrating the active-matrix substrate of its LCD panel.

[FIG. 30] FIGS. 30(a) and 30(b) are schematic representations illustrating how the LCD panel of the liquid crystal display device shown in FIG. 28 looks when representing an achromatic color and when representing a chromatic color, respectively.

[FIG. 31] FIG. 31 is a schematic representation illustrating a liquid crystal display device as a third preferred embodiment of the present invention.

[FIG. 32] FIG. 32(a) is a schematic representation illustrating how respective pixels may be arranged in the liquid crystal display device shown in FIG. 31, and FIG. 32(b) is a circuit diagram illustrating the active-matrix substrate of its LCD panel.

[FIG. 33] FIGS. 33(a) and 33(b) are schematic representations illustrating how the LCD panel of the liquid crystal display device shown in FIG. 31 looks when representing an achromatic color and when representing a chromatic color, respectively.

[FIG. 34] FIG. 34 is a schematic representation illustrating a configuration for the blue correcting section of the liquid crystal display device shown in FIG. 31.

[FIG. 35] FIG. 35 is a schematic representation illustrating a liquid crystal display device as a modified example of the third preferred embodiment of the present invention.

[FIG. 36] FIG. 36(a) is a schematic representation illustrating a liquid crystal display device as a fourth preferred embodiment of the present invention and FIG. 36(b) is an equivalent circuit diagram of its LCD panel.

[FIG. 37] FIG. 37 is a schematic representation showing the respective polarities and brightness levels of the liquid crystal display device shown in FIG. 36.

[FIG. 38] FIG. 38(a) is a schematic representation illustrating a liquid crystal display device as Comparative Example 3 and FIG. 38(b) is a schematic representation illustrating only blue subpixels of the liquid crystal display device of Comparative Example 3.

[FIG. 39] FIG. 39(a) is a schematic representation illustrating how the blue subpixels of the liquid crystal display device shown in FIG. 36 look when the hue coefficient H_b is equal to zero, FIG. 39(b) is a schematic representation showing how the blue correcting section changes the luminances and polarities, and FIG. 39(c) is a schematic

representation illustrating blue subpixels that have had their luminances corrected when the hue coefficient **Hb** is equal to one.

[FIG. 40] FIG. **40(a)** is a schematic representation illustrating how the blue subpixels of the liquid crystal display device shown in FIG. **36** look when the hue coefficient **Hb** is equal to zero, FIG. **40(b)** is a schematic representation showing how the blue correcting section changes the luminances and polarities, and FIG. **40(c)** is a schematic representation illustrating blue subpixels that have had their luminances corrected when the hue coefficient **Hb** is equal to one. [FIG. 41] FIG. **41(a)** is a schematic representation illustrating how the blue subpixels of the liquid crystal display device shown in FIG. **36** look when the hue coefficient **Hb** is equal to zero, FIG. **41(b)** is a schematic representation showing how the blue correcting section changes the luminances and polarities, and FIG. **41(c)** is a schematic representation illustrating blue subpixels that have had their luminances corrected when the hue coefficient **Hb** is equal to one.

[FIG. 42] FIG. **42(a)** is a schematic representation illustrating an LCD panel that is designed to make the correction shown in FIG. **41** for the liquid crystal display device and FIG. **42(b)** is a schematic representation illustrating a configuration for its blue correcting section.

[FIG. 43] FIG. **43** is a schematic representation illustrating a configuration for the blue correcting section of a liquid crystal display device as a modified example of the fourth preferred embodiment of the present invention.

[FIG. 44] FIG. **44(a)** is a schematic representation illustrating a liquid crystal display device as a fifth preferred embodiment of the present invention and FIG. **44(b)** is a schematic representation illustrating its LCD panel.

[FIG. 45] FIG. **45(a)** is a schematic representation illustrating a configuration for the blue correcting section shown in FIG. **44** and FIG. **45(b)** is a schematic representation illustrating its grayscale control section.

[FIG. 46] FIG. **46** is a schematic representation illustrating a configuration for the blue correcting section of a liquid crystal display device as a modified example of the fifth preferred embodiment of the present invention.

[FIG. 47] FIG. **47** is a schematic representation illustrating a liquid crystal display device as a sixth preferred embodiment of the present invention.

[FIG. 48] FIG. **48(a)** is a schematic representation illustrating how subpixels may be arranged in the multi-primary-color display panel of the liquid crystal display device shown in FIG. **47** and FIG. **48(b)** is a schematic representation illustrating where blue subpixels, of which the luminances need to be controlled, are located with respect to bright blue subpixels.

[FIG. 49] FIG. **49** is a schematic representation illustrating a configuration for the blue correcting section of the liquid crystal display device shown in FIG. **47**.

[FIG. 50] FIG. **50(a)** is a schematic representation illustrating how subpixels may be arranged in the multi-primary-color display panel of a liquid crystal display device as a modified example of the sixth preferred embodiment and FIG. **50(b)** is a schematic representation illustrating where blue subpixels, of which the luminances need to be controlled, are located with respect to bright blue subpixels.

[FIG. 51] FIG. **51(a)** is a schematic representation illustrating how subpixels may be arranged in the multi-primary-color display panel of a liquid crystal display device as another modified example of the sixth preferred embodiment and FIG. **51(b)** is a schematic representation illustrating where blue subpixels, of which the luminances need to be controlled, are located with respect to bright blue subpixels.

[FIG. 52] FIG. **52(a)** is a schematic representation illustrating how subpixels may be arranged in the multi-primary-color display panel of a liquid crystal display device as still another modified example of the sixth preferred embodiment and FIG. **52(b)** is a schematic representation illustrating where blue subpixels, of which the luminances need to be controlled, are located with respect to bright blue subpixels.

DESCRIPTION OF EMBODIMENTS

[0030] Hereinafter, preferred embodiments of a liquid crystal display device according to the present invention will be described with reference to the accompanying drawings. It should be noted, however, that the present invention is in no way limited to the specific preferred embodiments to be described below.

(EMBODIMENT 1)

[0031] A first specific preferred embodiment of a liquid crystal display device according to the present invention will now be described. FIG. **1(a)** is a schematic representation illustrating a liquid crystal display device **100A** as a first preferred embodiment of the present invention. The liquid crystal display device **100A** includes an LCD panel **200A** and a correcting section **300A**. The LCD panel **200A** has a number of pixels that are arranged in columns and rows to form a matrix pattern. In the LCD panel **200A** of this preferred embodiment, each of those pixels includes red, green and blue subpixels. In the following description, the liquid crystal display device will sometimes be simply referred to herein as just a "display device".

[0032] If necessary, the correcting section **300A** makes correction on either the grayscale level or its associated luminance level of at least one of red, green and blue subpixels in accordance with the input signal. In this preferred embodiment, the correcting section **300A** includes red, green and blue correcting sections **300r**, **300g** and **300b**.

[0033] Specifically, the red correcting section **300r** receives an input signal, indicating grayscale levels **r**, **g** and **b** for red, green and blue subpixels, and corrects the grayscale level **r** of the red subpixel into a different grayscale level **r'**. Likewise, the green correcting section **300g** also receives the input signal indicating the grayscale levels **r**, **g** and **b** of the red, green and blue subpixels and corrects the grayscale level **g** of the green subpixel into a different grayscale level **g'**. In the same way, the blue correcting section **300b** also receives the input signal indicating the grayscale levels **r**, **g** and **b** of the red, green and blue subpixels and corrects the grayscale level **b** of the blue subpixel into a different grayscale level **b'**. It should be noted that at least one of those corrected grayscale levels **r'**, **g'** and **b'** to be output from the correcting section **300A** could be equal to the original grayscale level **r**, **g** or **b** as input to the correcting section **300A**.

[0034] The input signal may be compatible with a cathode ray tube (CRT) with a γ value of 2.2 and is compliant with the NTSC (National Television Standards Committee) standard. In general, the grayscale levels **r**, **g** and **b** indicated by the input signal are represented by eight bits. Or the input signal may have a value that can be converted into the grayscale levels **r**, **g** and **b** of red, green and blue subpixels and that is represented as a three-dimensional value. In FIG. **1(a)**, the grayscale levels **r**, **g** and **b** of the input signal are collectively identified by **rgb**. It should be noted that if the input signal is compliant with the BT. 709 standard, the grayscale levels **r**, **g** and **b** indicated by the input signal fall within the range of the lowest grayscale level (e.g., grayscale level 0) through the highest grayscale level (e.g., grayscale level 255) and the luminances of the red, green and blue subpixels fall within the range of zero through one. The input signal may be YCrCb signal, for example. The grayscale levels **rgb** indicated by the input signal are input through the correcting section **300A** to the LCD panel **200A**, which converts the grayscale levels into luminance levels. As a result, voltages representing the luminance levels are applied to the liquid crystal layer **260** of the LCD panel **200A** (see FIG. **1(b)**).

[0035] In a three-primary-color liquid crystal display device, if either the grayscale levels or luminance levels of red, green and blue subpixels are all zero, a pixel displays the color black. On the other hand, if either the grayscale levels or luminance levels of red, green and blue subpixels are all one, then a pixel displays the color white. Optionally, a liquid crystal display device may perform independent gamma correction processing as will be described later. In a liquid crystal display device in which no independent gamma correction is carried out, however, if the highest luminance of red, green and blue subpixels after the color temperatures have been adjusted to the intended ones in a TV set is supposed to be one and if an achromatic color is going to be displayed, then the red, green and blue subpixels have either the same grayscale level or the same maximum luminance ratio of the luminance levels. That is why if the color represented by a pixel changes from black into white while remaining an achromatic color, then the grayscale level of the red, green and blue subpixels or the maximum luminance ratio of the luminance levels does increase but is still the same between those red, green and blue subpixels. In the following description, if the luminance of each subpixel in an LCD panel is the lowest one corresponding to the lowest grayscale level, then that subpixel will be referred to herein as an "OFF-state subpixel". On the other hand, if the luminance of each subpixel is higher than that lowest luminance, then that subpixel will be referred to herein as an "ON-state subpixel".

[0036] FIG. **1(b)** is a schematic representation illustrating the LCD panel **200A**, which includes an active-matrix substrate **220** with pixel electrodes **224** and an alignment layer **226** that have been provided on an insulating substrate **222**, a counter substrate **240** with a counter electrode **244** and another alignment layer **246** that have also been provided on another insulating substrate **242**, and a liquid crystal layer **260**, which is interposed between the active-matrix substrate **220** and the counter substrate **240**. Although not shown, two polarizers are provided for the active-matrix substrate **220** and the counter substrate **240**, respectively, and are arranged so that their polarization axes satisfy the crossed Nicols relation. Although not shown in FIG. **1(b)**, lines, insulating layers, etc. are actually assembled on the active-matrix substrate **220**, while a color filter layer etc. are actually provided for the counter substrate **240**. The liquid crystal layer **260** has a substantially uniform thickness. In the LCD panel **200A**, a number of pixels are arranged in columns and rows to form a matrix pattern. Each of those pixels is defined by an associated pixel electrode **224** and the red, green and blue subpixels are defined by divided subpixel electrodes of the pixel electrode **224**.

[0037] This LCD panel **200A** operates in the VA mode, for example. Thus, the alignment layers **226** and **246** are vertical alignment layers and the liquid crystal layer **260** is a vertical alignment liquid crystal layer. As used herein, the "vertical alignment liquid crystal layer" refers to a liquid crystal layer in which the axis of its liquid crystal molecules (which will be sometimes referred to herein as an "axial direction") defines an angle of approximately 85 degrees or more with respect to the surface of the vertical alignment layers **226** and **246**. The liquid crystal layer **260** includes a nematic liquid crystal material with negative dielectric anisotropy. Using such a liquid crystal material along with two polarizers that are arranged as crossed Nicols, this device conducts a display operation in a normally black mode. Specifically, in that mode, when no voltage is applied to the liquid crystal layer **260**, the liquid crystal molecules **262** in the liquid crystal layer **260** are aligned substantially parallel to a normal to the principal surface of the alignment layers **226** and **246**. On the other hand, when a voltage that is higher than a predetermined voltage is applied to the liquid crystal layer **260**, the liquid crystal molecules **262** in the liquid crystal layer **260** are aligned substantially parallel to the principal surface of the

alignment layers **226** and **246**. Also, when a high voltage is applied to the liquid crystal layer **260**, the liquid crystal molecules **262** will be aligned symmetrically either within a subpixel or within a particular region of the subpixel, thus contributing to improving the viewing angle characteristic. In this example, each of the active-matrix substrate **220** and the counter substrate **240** has its alignment layer **226, 246**. However, according to the present invention, at least one of the active-matrix substrate **220** and the counter substrate **240** needs to have its alignment layer **226** or **246**. Nevertheless, in order to stabilize the alignments, it is still preferred that both of the active-matrix substrate **220** and the counter substrate **240** have their own alignment layer **226, 246**.

[0038] FIG. **2(a)** illustrates how pixels and subpixels, included in each of those pixels, may be arranged in this LCD panel **200A**. As an example, FIG. **2(a)** illustrates an arrangement of pixels in three columns and three rows. Each of those pixels includes three subpixels, which are red, green and blue subpixels **R, G** and **B** that are arranged in the row direction. The luminances of these subpixels can be controlled independently of each other. The arrangement of color filters in this LCD panel **200A** corresponds to the arrangement shown in FIG. **2(a)**.

[0039] In the following description, a subpixel's luminance level corresponding to the lowest grayscale level (e.g., grayscale level 0) will be represented herein as "0" and a subpixel's luminance level corresponding to the highest grayscale level (e.g., grayscale level 255) will be represented herein as "1" for convenience sake. Even if their luminance levels are equal to each other, the red, green and blue subpixels may actually have mutually different luminances because the "luminance level" herein means the ratio of the luminance of each subpixel to its highest luminance. For example, if the input signal indicates that a pixel should represent the color black, all of the grayscale levels **r, g** and **b** indicated by the input signal are the lowest grayscale level (e.g., grayscale level 0). On the other hand, if the input signal indicates that a pixel should represent the color white, all of the grayscale levels **r, g** and **b** are the highest grayscale level (e.g., grayscale level 255). In the following description, the grayscale level will sometimes be normalized with the highest grayscale level and the grayscale level will be represented as a ratio of zero through one.

[0040] FIG. **2(b)** illustrates an equivalent circuit diagram of one pixel in this liquid crystal display device **100A**. A TFT **230** is connected to a subpixel electrode 224b that is provided for a blue subpixel **B**. The TFT **230** has its gate electrode connected to a gate bus line **Gate** and its source electrode connected to a source bus line **Sb**. The other red and green subpixels **R** and **G** also have the same configuration.

[0041] FIG. **3** is a chromaticity diagram of the LCD panel **200A**. If the grayscale level of a red subpixel is the highest one and if that of green and blue subpixels is the lowest one, then the LCD panel **200A** has the R chromaticity shown in FIG. **3**. On the other hand, if the grayscale level of the green subpixel is the highest one and if that of red and blue subpixels is the lowest one, then the LCD panel **200A** has the G chromaticity shown in FIG. **3**. And if the grayscale level of a blue subpixel is the highest one and if that of red and green subpixels is the lowest one, then the LCD panel **200A** has the B chromaticity shown in FIG. **3**. The color reproduction range of the liquid crystal display device **100A** is represented by the triangle, of which the vertices are defined by R, G and B coordinates shown in FIG. **3**.

[0042] Hereinafter, it will be outlined with reference to FIGS. **1** and **4** how the liquid crystal display device **100A** of this preferred embodiment operates in principle. In the example to be described below, the input signal is supposed to indicate that each and every pixel should represent the same color for the sake of simplicity. Also, the grayscale levels of respective subpixels indicated by the input signal will be identified by r, g and b, which will sometimes be referred to herein as "reference grayscale levels".

[0043] FIGS. **4(a), 4(b)** and **4(c)** illustrate the appearance of the LCD panel **200A** of this liquid crystals display device **100A**. In FIG. **4(a)**, the input signal indicates that every pixel should represent the same achromatic color. On the other hand, in FIGS. **4(b)** and **4(c)**, the input signal indicates that every pixel should represent the same chromatic color.

[0044] In each of FIGS. **4(a), 4(b)** and **4(c)**, two pixels that are adjacent to each other in the row direction are taken as an example. One of those two pixels is identified by P1 and its red, green and blue subpixels are identified by R1, G1 and B1, respectively. The other pixel is identified by P2 and its red, green and blue subpixels are identified by R2, G2 and B2, respectively.

[0045] First of all, it will be described with reference to FIG. **4 (a)** how the LCD panel **200A** looks when the color indicated by the input signal is an achromatic color. In such a situation, the grayscale levels of the red, green and blue subpixels are equal to each other.

[0046] The red, green and blue correcting sections **300r, 300g** and **300b** shown in FIG. **1(a)** make corrections so that in this LCD panel **200A**, the luminances of the red, green and blue subpixels **R1, G1** and **B1** of one **P1** of the two adjacent pixels are different from those of the red, green and blue subpixels **R2, G2** and **B2** of the other pixel **P2**. In FIG. **4(a)**, look at any two subpixels that are adjacent to each other in the row direction, and it can be seen that their brightness levels are opposite to each other. And the same can be said about any two subpixels that are adjacent to each other in the column direction, too. Also, look at two subpixels (e.g., red subpixels) belonging to two pixels that are adjacent to each other in the row direction, and it can be seen that their brightness levels are opposite to each other. And the same can be said about any two subpixels (e.g., red subpixels) belonging to two pixels that are adjacent to each other in the column direction, too.

[0047] Using two red subpixels belonging to two adjacent pixels as a unit, the red correcting section **300r** controls the

luminances of those red subpixels. That is why even if the input signal indicates that such red subpixels belonging to two adjacent pixels have the same grayscale level, the LCD panel **200A** corrects the grayscale level so that those two red subpixels have mutually different luminances. As a result of this correction, one of the two red subpixels belonging to those two adjacent pixels has its luminance increased by the magnitude of shift $\Delta s\alpha$, while the other red subpixel has its luminance decreased by the magnitude of shift $\Delta s\beta$. Consequently, those two red subpixels belonging to the two adjacent pixels have mutually different luminances. In the same way, the green correcting section **300g** uses two green subpixels belonging to two adjacent pixels as a unit to control the luminances of those two green subpixels, and the blue correcting section **300b** uses two blue subpixels belonging to two adjacent pixels as a unit to control the luminances of those two blue subpixels.

[0048] In two subpixels in the same color that belong to two adjacent pixels, one subpixel with the higher luminance will be referred to herein as a "bright subpixel", while the other subpixel with the lower luminance as a "dark subpixel". In this case, the luminance of the bright subpixel is higher than a luminance corresponding to a reference grayscale level, while that of the dark subpixel is lower than the luminance corresponding to the reference grayscale level. Also, in two sets of red, green and blue subpixels belonging to two adjacent pixels, the red, green and blue subpixels that have the higher luminance will be referred to herein as a "bright red subpixel", a "bright green subpixel" and a "bright blue subpixel", respectively, while the red, green and blue subpixels that have the lower luminance will be referred to herein as a "dark red subpixel", a "dark green subpixel" and a "dark blue subpixel", respectively. For example, the red and blue subpixels **R1** and **B1** belonging to the pixel **P1** are bright subpixels and the green subpixel **G1** belonging to the pixel **P1** is a dark subpixel. On the other hand, the red and blue subpixels **R2** and **B2** belonging to the pixel **P2** are dark subpixels and the green subpixel **G2** belonging to the pixel **P2** is a bright subpixel.

[0049] Also, when the screen is viewed straight on, the difference between the luminance of the bright subpixel and the luminance corresponding to the reference grayscale level is substantially equal to the difference between the luminance corresponding to the reference grayscale level and the luminance of the dark subpixel, and the magnitude of shift $\Delta s\alpha$ is ideally equal to the magnitude of shift $\Delta s\beta$ for each of the red, green and blue subpixels. That is why the average of the luminances of respective subpixels belonging to two adjacent pixels in this LCD panel **200A** as viewed straight on is substantially equal to that of the luminances corresponding to the grayscale levels of two adjacent subpixels as indicated by the input signal. In this preferred embodiment, the red, green and blue correcting sections **300r**, **300g** and **300b** make corrections on the grayscale levels of subpixels belonging to two pixels that are adjacent to each other in the row direction.

[0050] If the red, green and blue correcting sections **300r**, **300g** and **300b** make such corrections, the two subpixels of the same color belonging to two adjacent pixels have mutually different grayscale-luminance characteristics (i.e., different gamma characteristics). As a result, the viewing angle characteristic when the screen is viewed obliquely can be improved. In that case, the colors represented by those two adjacent pixels are strictly different from each other. However, if the LCD panel **200A** has a sufficiently high resolution, the color sensed by a human viewer with his or her eyes will be the average of those two colors represented by the two adjacent pixels.

[0051] For example, if the input signal indicates that the grayscale levels (r, g, b) of the red, green and blue subpixels should be (100, 100, 100), the liquid crystal display device **100A** corrects the grayscale levels of those subpixels into either $137 (= (2 \times (100/255)^{2.2})^{1/2.2} \times 255)$ or zero. As a result, in the LCD panel **200A**, the red, green and blue subpixels **R1**, **G1** and **B1** belonging to the pixel **P1** come to have luminances corresponding to the grayscale levels (137, 0, 137), while the red, green and blue subpixels **R2**, **G2** and **B2** belonging to the pixel **P2** come to have luminances corresponding to the grayscale levels (0, 137, 0).

[0052] Next, it will be described with reference to FIG. 4(b) how the LCD panel **200A** looks when the input signal indicates that a chromatic color should be represented. In this case, the input signal is supposed to indicate that the blue subpixel should have a higher grayscale level than the red and green subpixels.

[0053] For example, if the input signal indicates that the grayscale levels of the red, green and blue subpixels should be (50, 50, 100), the liquid crystal display device **100A** corrects the grayscale levels of the red and green subpixels into either $69 (= (2 \times (50/255)^{2.2})^{1/2.2} \times 255)$ or zero. As a result, the bright red subpixel and the bright green subpixel do turn ON but the dark red subpixel and the dark green subpixel are OFF. On the other hand, the grayscale level of the blue subpixel is corrected differently from the red and green subpixels. Specifically, the grayscale level of 100 of the blue subpixel indicated by the input signal is corrected into either 121 or 74. It should be noted that $2 \times (100/255)^{2.2} = (121/255)^{2.2} + (74/255)^{2.2}$. As a result, the bright blue subpixel and the dark blue subpixel both turn ON. Consequently, the red, green and blue subpixels **R1**, **G1** and **B1** belonging to the pixel **P1** in this LCD panel **200A** come to have luminances corresponding to the grayscale levels (69, 0, 121) and the red, green and blue subpixels **R2**, **G2** and **B2** belonging to the pixel **P2** come to have luminances corresponding to the grayscale levels (0, 69, 74).

[0054] When the input signal indicates that a chromatic color should be represented, this liquid crystal display device **100A** corrects the grayscale level of a blue subpixel differently from when the input signal indicates that an achromatic color should be represented. If in a situation where the input signal indicates that the red, green and blue subpixels have grayscale levels (50, 50, 100), the grayscale level of the blue subpixel were corrected in the same way as in a situation

where an achromatic color should be represented, then the difference $\Delta u'v'$ between the chromaticity when the screen is viewed obliquely and the chromaticity when the screen is viewed straight on (which will be referred to herein as a "chromaticity difference") would be 0.047. If the chromaticity difference $\Delta u'v'$ were relatively big in this manner, the color would look different depending on whether the screen is viewed obliquely or straight on. To avoid such an unwanted situation, when a chromatic color should be represented, this liquid crystal display device **100A** corrects the grayscale level of the blue subpixel differently from when an achromatic color should be represented. As a result, the difference $\Delta u'v'$ between the chromaticity when the screen is viewed obliquely and the chromaticity when the screen is viewed straight on becomes 0.026. Consequently, the liquid crystal display device **100A** can reduce the chromaticity difference $\Delta u'v'$ significantly and minimize the color shift. In the example that has just been described with reference to FIG. **4(b)**, when the input signal indicates that a chromatic color should be represented, the luminance of the blue subpixel is corrected into a different value. However, the luminance of the blue subpixel may remain the same.

[0055] Next, it will be described with reference to FIG. **4(c)** how the LCD panel **200A** looks when the input signal indicates that another chromatic color should be represented. For example, if the input signal indicates that the grayscale levels of the red, green and blue subpixels should be (0, 0, 100), the red and green subpixels do not have their grayscale levels changed but have a luminance corresponding to the grayscale level of 0 in this liquid crystal display device **100A**. On the other hand, this liquid crystal display device **100A** changes the grayscale level of the blue subpixel differently from when an achromatic color should be represented. Specifically, the blue subpixel does not have its grayscale level changed but has a grayscale level corresponding to the grayscale level of 100 as indicated by the input signal. Consequently, the red, green and blue subpixels **R1**, **G1** and **B1** belonging to the pixel **P1** in this LCD panel **200A** come to have luminances corresponding to the grayscale levels (0, 0, 100), so do the red, green and blue subpixels **R2**, **G2** and **B2** belonging to the pixel **P2**.

[0056] Hereinafter, advantages of the liquid crystal display device **100A** of this preferred embodiment over its counterparts as Comparative Examples 1 and 2 will be described. In the example to be described below, the input signal is supposed to indicate that every pixel should represent the same color to avoid complicating the description overly.

[0057] First of all, a liquid crystal display device will be described as Comparative Example 1 with reference to FIG. 5. In the liquid crystal display device of this Comparative Example 1, the grayscale levels never change, no matter what grayscale levels are indicated by the input signal for respective subpixels.

[0058] FIG. **5(a)** is a schematic representation illustrating how the LCD panel of the liquid crystal display device of Comparative Example 1 looks when the input signal indicates that every pixel should represent an achromatic color. For example, if the highest grayscale level is supposed to be 255, the grayscale levels of red, green and blue subpixels as indicated by the input signal are (100, 100, 100).

[0059] If the input signal indicates that the grayscale levels of red, green and blue subpixels should be (100, 100, 100), the grayscale levels never change in this liquid crystal display device as Comparative Example 1. That is why the luminances of the respective subpixels correspond to the grayscale levels (100, 100, 100).

[0060] FIG. **5(b)** is a schematic representation illustrating how the LCD panel of the liquid crystal display device of Comparative Example 1 looks when the input signal indicates that every pixel should represent the same chromatic color. For example, if the highest grayscale level is supposed to be 255, the grayscale levels of red, green and blue subpixels as indicated by the input signal are (50, 50, 100).

[0061] If the input signal indicates that the grayscale levels of red, green and blue subpixels should be (50, 50, 100), the grayscale levels never change. That is why the luminances of the respective subpixels correspond to the grayscale levels (50, 50, 100).

[0062] FIG. **5(c)** shows how the grayscale when the screen is viewed straight on (which will be referred to herein as "straight viewing grayscale") and the grayscale when the screen is viewed obliquely (which will be referred to herein as "obliquely viewing grayscale") change with respect to the reference grayscale level in the liquid crystal display device of Comparative Example 1. In this case, the straight viewing grayscale and the obliquely viewing grayscale are relative grayscale levels representing relative luminances by grayscales. Also, in this example, the obliquely viewing grayscale is a relative grayscale level when the viewing direction defines an angle of 60 degrees with respect to a normal to the display screen.

[0063] The straight viewing grayscale increases proportionally to the reference grayscale level. On the other hand, as the reference grayscale level increases, the obliquely viewing grayscale increases monotonically. At low grayscales, however, the higher the reference grayscale level, the greater the difference between the obliquely viewing and straight viewing grayscales and the more noticeable the whitening phenomenon gets. But at middle to high grayscales, the higher the reference grayscale level, the smaller the difference between the obliquely viewing and straight viewing grayscales and the less perceptible the whitening phenomenon gets.

[0064] In FIG. **5(c)**, the differences between the obliquely viewing and straight viewing grayscales when the grayscale levels of red, green and blue subpixels in the liquid crystal display device of Comparative Example 1 are 100 are identified by ΔR_{100} , ΔG_{100} and ΔB_{100} , respectively. On the other hand, the differences between the obliquely viewing and straight viewing grayscales when the reference grayscale levels of red and green subpixels are 50 are identified by

ΔR_{150} and ΔG_{150} , respectively. Generally speaking, when an achromatic color is going to be represented, settings are usually determined so that there is only little difference in the color represented depending on whether the screen is viewed obliquely or straight on. And these differences ΔR_{100} , ΔG_{100} and ΔB_{100} are equal to each other. Also, in the liquid crystal display device of Comparative Example 1, ΔR_{100} , ΔG_{100} , ΔB_{100} , ΔR_{50} and ΔG_{50} are so large

that the whitening phenomenon arises to a significant degree.

[0065] Next, a liquid crystal display device will be described as Comparative Example 2. The liquid crystal display device of this Comparative Example 2 makes correction using necessary one(s) of the grayscale levels that are indicated by the input signal for red, green and blue subpixels, thereby trying to improve the viewing angle characteristic.

[0066] FIG. 6(a) is a schematic representation illustrating how the LCD panel of the liquid crystal display device of Comparative Example 2 looks when the input signal indicates that every pixel should represent an achromatic color. For example, if the highest grayscale level is supposed to be 255, the grayscale levels of red, green and blue subpixels as indicated by the input signal are (100, 100, 100).

[0067] If the input signal indicates that the grayscale levels of the red, green and blue subpixels should be (100, 100, 100), the liquid crystal display device of this Comparative Example 2 corrects the grayscale levels of the red, green and blue subpixels into either 137 ($= (2 \times (100/255)^{2.2})^{1/2.2} \times 255$) or zero. As a result, in the liquid crystal display device of this Comparative Example 2, the red, green and blue subpixels **R1**, **G1** and **B1** belonging to the pixel **P1** come to have luminances corresponding to the grayscale levels (137, 0, 137), while the red, green and blue subpixels **R2**, **G2** and **B2** belonging to the pixel **P2** come to have luminances corresponding to the grayscale levels (0, 137, 0). In the liquid crystal display device of Comparative Example 2, any two subpixels that are adjacent to each other in the row or column direction have opposite brightness levels and any two subpixels that are diagonally adjacent to each other have the same luminance. Also, if attention is paid to two subpixels of the same color (e.g., red subpixels) that belong to two different pixels, two subpixels of two pixels that are adjacent to each other in the row or column direction have opposite brightness levels and two subpixels of two pixels that are diagonally adjacent to each other have the same luminance.

[0068] FIG. 6(b) is a schematic representation illustrating how the LCD panel of the liquid crystal display device of Comparative Example 2 looks when the input signal indicates that every pixel should represent the same chromatic color. For example, if the highest grayscale level is supposed to be 255, the grayscale levels of red, green and blue subpixels as indicated by the input signal are (50, 50, 100).

[0069] If the input signal indicates that the grayscale levels of the red, green and blue subpixels should be (50, 50, 100), the grayscale levels of the red and green subpixels are corrected into either 69 ($= (2 \times (50/255)^{2.2})^{1/2.2} \times 255$) or zero. On the other hand, the blue subpixel comes to have a luminance corresponding to a grayscale level of 137 ($= (2 \times (100/255)^{2.2})^{1/2.2} \times 255$) or zero. As a result, in the liquid crystal display device of this Comparative Example 2, the red, green and blue subpixels **R1**, **G1** and **B1** belonging to the pixel **P1** come to have luminances corresponding to the grayscale levels (69, 0, 137), while the red, green and blue subpixels **R2**, **G2** and **B2** belonging to the pixel **P2** come to have luminances corresponding to the grayscale levels (0, 69, 0). In this case, the whitening phenomenon to arise when the screen is viewed obliquely can also be minimized.

[0070] FIG. 6(c) shows how the straight viewing and obliquely viewing grayscales change with respect to the reference grayscale level in the liquid crystal display device of Comparative Example 2. In FIG. 6(c), also indicated by the dashed curve for your reference is the obliquely viewing grayscale of the liquid crystal display device of Comparative Example 1 shown in FIG. 5(c). Compared to the obliquely viewing grayscales of the liquid crystal display device of Comparative Example 1, those of the liquid crystal display device of this Comparative Example 2 are much lower particularly at low to middle grayscales. Consequently, in the liquid crystal display device of this Comparative Example 2, the degree of whitening observed is generally lower than in the counterpart of Comparative Example 1 described above.

[0071] In FIG. 6(c), the differences between the obliquely viewing and straight viewing grayscales when the grayscale levels of red, green and blue subpixels in the liquid crystal display device of Comparative Example 2 are 100 (i.e., when the average luminance of the red subpixels **R1** and **R2**, that of the green subpixels **G1** and **G2**, and that of the blue subpixels **B1** and **B2** all correspond to the grayscale level of 100) are identified by ΔR_{100} , ΔG_{100} and ΔB_{100} , respectively. On the other hand, the differences between the obliquely viewing and straight viewing grayscales when the reference grayscale levels of red and green subpixels are 50 are identified by ΔR_{50} and ΔG_{50} , respectively. Generally speaking, when an achromatic color is going to be represented, settings are usually determined so that there is only little difference in the color represented depending on whether the screen is viewed obliquely or straight on. And ΔR_{100} , ΔG_{100} and ΔB_{100} are equal to each other. Also shown in FIG. 6(c) for your reference is ΔB_{100} mentioned above. Since ΔB_{100} is smaller than ΔB_{100} as shown in FIG. 6(c), it can be seen that the whitening phenomenon has been reduced in this comparative example.

[0072] Nonetheless, ΔB_{100} is smaller than ΔR_{50} or ΔG_{50} . That is why if the input signal indicates that the red, green and blue subpixels should have grayscale levels (50, 50, 100), the color as viewed obliquely will look a bit more yellowish than the color as viewed straight on in this liquid crystal display device. Consequently, in the liquid crystal display device of this Comparative Example 2, the color shift increases when a chromatic color is going to be represented.

[0073] Next, a liquid crystal display device **100A** according to this preferred embodiment will be described with reference

to FIG. 7. The liquid crystal display device **100A** of this preferred embodiment corrects the grayscale level of a blue subpixel based on not only the grayscale level of the blue subpixel itself but also those of red and green subpixels as well, which is a major difference from the liquid crystal display device of Comparative Example 2.

[0074] FIG. 7(a) is a schematic representation illustrating how the LCD panel **200A** of this liquid crystal display device **100A** looks when the input signal indicates that every pixel should represent an achromatic color. For example, if the highest grayscale level is supposed to be 255, the grayscale levels of red, green and blue subpixels as indicated by the input signal are (100, 100, 100).

[0075] If the input signal indicates that the grayscale levels of the red, green and blue subpixels should be (100, 100, 100), the liquid crystal display device **100A** corrects the grayscale levels of the red, green and blue subpixels into either $137 = (2 \times (100/255)^{2.2})^{1/2.2} \times 255$ or zero. As a result, in the liquid crystal display device **100A**, the red, green and blue subpixels **R1**, **G1** and **B1** belonging to the pixel **P1** come to have luminances corresponding to the grayscale levels (137, 0, 137), while the red, green and blue subpixels **R2**, **G2** and **B2** belonging to the pixel **P2** come to have luminances corresponding to the grayscale levels (0, 137, 0). In this case, the degree of whitening to arise when the screen is viewed obliquely has been reduced.

[0076] FIG. 7(b) is a schematic representation illustrating how the LCD panel **200A** of this liquid crystal display device **100A** looks when the input signal indicates that every pixel should represent the same chromatic color. For example, the grayscale levels of red, green and blue subpixels as indicated by the input signal may be (50, 50, 100).

[0077] If the input signal indicates that the grayscale levels of the red, green and blue subpixels should be (50, 50, 100), the liquid crystal display device **100A** corrects the grayscale levels of the red and green subpixels into either $69 = (2 \times (50/255)^{2.2})^{1/2.2} \times 255$ or zero. On the other hand, the grayscale level of the blue subpixel is corrected differently from the red and green subpixels. Specifically, the grayscale level of 100 of the blue subpixel is corrected into either 121 or 74. It should be noted that $2 \times (100/255)^{2.2} = ((121/255)^{2.2} + (74/255)^{2.2})$. Consequently, the red, green and blue subpixels **R1**, **G1** and **B1** belonging to the pixel **P1** in this liquid crystal display device **100A** come to have luminances corresponding to the grayscale levels (69, 0, 121) and the red, green and blue subpixels **R2**, **G2** and **B2** belonging to the pixel **P2** come to have luminances corresponding to the grayscale levels (0, 69, 74).

[0078] FIG. 7(c) shows how the obliquely viewing grayscale changes with respect to the reference grayscale level in this liquid crystal display device **100A**. In FIG. 7(c), also shown for your reference are the obliquely viewing grayscales of the liquid crystal display devices of Comparative Examples 1 and 2 shown in FIGS. 5(c) and 6(c) and indicated by the dashed curve and the solid curve, respectively.

[0079] As already described with reference to FIG. 7(b), if the input signal indicates that the grayscale levels of the red, green and blue subpixels should be (50, 50, 100), the liquid crystal display device **100A** of this preferred embodiment corrects the grayscale level of the blue subpixel differently from the red and green subpixels, and therefore, the obliquely viewing grayscale of the blue subpixel changes differently from that of the red or green subpixel. In FIG. 7(c), the differences between the obliquely viewing grayscales of the red and green subpixels as indicated by the solid curve and the straight viewing grayscale are identified by ΔRA_{50} and ΔGA_{50} , respectively. On the other hand, the difference between the obliquely viewing grayscale of the blue subpixel as indicated by the dotted curve and the straight viewing grayscale is identified by ΔBA_{100} . Also, in FIG. 7(c), the differences between the obliquely viewing and straight viewing grayscales of the liquid crystal display devices of Comparative Examples 1 and 2 when the blue subpixel has a reference grayscale level of 100 are identified by $\Delta B1_{100}$ and $\Delta B2_{100}$, respectively.

[0080] As described above, if the input signal indicates that the red, green and blue subpixels should have grayscale levels (50, 50, 100), the color as viewed obliquely will look a bit more yellowish in the liquid crystal display device of Comparative Example 2 than the color as viewed straight on because $\Delta B2_{100}$ is smaller than $\Delta R2_{50}$ or $\Delta G50$. On the other hand, the grayscale level difference ΔBA_{100} from the grayscale levels of 121 and 74 of the blue subpixel in the liquid crystal display device **100A** of this preferred embodiment is smaller than the grayscale level difference $\Delta B1_{100}$ from the grayscale level of 100, 100 of the blue subpixel in the liquid crystal display device of Comparative Example 1 and larger than the grayscale level difference $\Delta B2_{100}$ from the grayscale levels of 137 and 0 of the blue subpixel in the liquid crystal display device of Comparative Example 2. And the grayscale level difference ΔBA_{100} is closer to the grayscale level differences ΔRA_{50} and ΔGA_{50} rather than the grayscale level differences $\Delta B1_{100}$ and $\Delta B2_{100}$. Consequently, this liquid crystal display device **100A** can reduce the color shift.

[0081] The following table 1 shows x, y and Y values that are obtained by viewing the liquid crystal display device of Comparative Example 1 straight on and obliquely from a viewing angle of 60 degrees and the chromaticity difference $\Delta u'v'$ between the straight viewing and obliquely viewing directions when the input signal indicates that red, green and blue subpixels should have grayscale levels (150, 0, 50):

[0082]

Table 1

	x	y	Y	$\Delta u' v'$
Viewed straight on	0.610	0.301	0.116	-
Viewed obliquely (60°)	0.424	0.208	0.134	0.133

[0083] For example, if the input signal indicates that the red, green and blue subpixels should have grayscale levels (150, 0, 50), the grayscale levels **b1'** and **b2'** become 69 and 0, respectively, in the liquid crystal display device **100A** of this preferred embodiment. The following table 2 shows x, y and Y values that are obtained in such a situation by viewing the device straight on and obliquely from a viewing angle of 60 degrees and the chromaticity difference $\Delta u' v'$ between the straight viewing and obliquely viewing directions:

[0084]

Table 2

	x	y	Y	$\Delta u' v'$
Viewed straight on	0.610	0.301	0.116	-
Viewed obliquely (60°)	0.483	0.239	0.127	0.078

[0085] Compare Table 2 to Table 1, and it can be seen easily that this liquid crystal display device **100A** can reduce the color shift when the screen is viewed obliquely. In the liquid crystal display device of Comparative Example 2, not just the grayscale levels **b1'** and **b2'** of the blue subpixels but also those **r1'** and **r2'** of the red subpixels are corrected into level 69, level 0, level 205 ($= (2 \times (150/255)^{2.2})^{1/2.2} \times 255$) and level 0, respectively. The following table 3 shows x, y and Y values that are obtained in such a situation by viewing the device straight on and obliquely from a viewing angle of 60 degrees and the chromaticity difference $\Delta u' v'$ between the straight viewing and obliquely viewing directions:

[0086]

Table 3

	X	Y	Y	$\Delta u' v'$
Viewed straight on	0.610	0.301	0.116	-
Viewed obliquely (60°)	0.441	0.219	0.095	0.119

[0087] Comparing Table 3 to Tables 1 and 2, it can be seen that since the liquid crystal display device of Comparative Example 2 makes correction on each subpixel based on only the grayscale level of that subpixel, color shift is produced more significantly when the screen is viewed obliquely than in the liquid crystal display device **100A** of this preferred embodiment. Consequently, by making correction on each subpixel based on its hue and other factors, the color shift can be reduced.

[0088] Hereinafter, the blue correcting section **300b** will be described with reference to FIGS. 8 and 9. FIG. 8 is a schematic representation illustrating the configuration of the blue correcting section **300b**. In FIG. 8, the grayscale levels **r1**, **g1** and **b1** are indicated by the input signal for the respective subpixels **R1**, **G1** and **B1** of the pixel **P1** shown in FIGS. 7(a) and 7(b), while the grayscale levels **r2**, **g2** and **b2** are indicated by the input signal for the respective subpixels **R2**, **G2** and **B2** of the pixel **P2**. The red correcting section **300r** for correcting the grayscale levels **r1** and **r2** and the green correcting section **300g** for correcting the grayscale levels **g1** and **g2** have the same configuration as this blue correcting section **300b** and description thereof will be omitted herein.

[0089] First of all, the average of the grayscale levels **b1** and **b2** is calculated by using an adding section **310b**. In the following description, the average of the grayscale levels **b1** and **b2** will be referred to herein as an average grayscale level b_{ave} . Next, a grayscale level difference section 320 calculates two grayscale level differences $\Delta b \alpha$ and $\Delta b \beta$ with respect to the single average grayscale level b_{ave} . The grayscale level differences $\Delta b \alpha$ and $\Delta b \beta$ are associated with a bright blue subpixel and a dark blue subpixel, respectively.

[0090] In this manner, the grayscale level difference section **320** calculates two grayscale level differences $\Delta b \alpha$ and $\Delta b \beta$ with respect to the single average grayscale level b_{ave} . In this case, the average grayscale level b_{ave} and the grayscale level differences $\Delta b \alpha$ and $\Delta b \beta$ may satisfy the predetermined relation shown in FIG. 9(a), for example. As the average grayscale level B_{ave} increases from a low grayscale toward a predetermined middle grayscale, the grayscale level differences $\Delta b \alpha$ and $\Delta b \beta$ both increase. On the other hand, as the average grayscale level b_{ave} increases from

the predetermined middle grayscale toward a high grayscale, the grayscale level differences $\Delta b\alpha$ and $\Delta b\beta$ both decrease. The grayscale level difference section 320 may determine the grayscale level differences $\Delta b\alpha$ and $\Delta b\beta$ with respect to the average grayscale level b_{ave} by reference to a lookup table. Alternatively, the grayscale level difference section 320 may also determine the grayscale level differences $\Delta b\alpha$ and $\Delta b\beta$ by performing predetermined computations on the average grayscale level b_{ave} .

[0091] Next, a grayscale-to-luminance converting section 330 converts the grayscale level differences $\Delta b\alpha$ and $\Delta b\beta$ into luminance level differences $\Delta Y_b\alpha$ and $\Delta Y_b\beta$, respectively. In this case, the greater the luminance level difference $\Delta Y_b\alpha$, $\Delta Y_b\beta$, the greater the magnitude of shift $\Delta s\alpha$, $\Delta s\beta$. Ideally, the magnitude of shift $\Delta s\alpha$ is equal to the magnitude of shift $\Delta s\beta$. That is why the grayscale level difference section 320 may give only one of the grayscale level differences $\Delta b\alpha$ and $\Delta b\beta$ to calculate only one of the magnitudes of shift $\Delta s\alpha$ and $\Delta s\beta$.

[0092] Meanwhile, the average of the grayscale levels $r1$ and $r2$ is calculated by another adding section 310r and that of the grayscale levels $g1$ and $g2$ is calculated by still another adding section 310g. In the following description, the average of the grayscale levels $r1$ and $r2$ will be referred to herein as an average grayscale level r_{ave} and that of the grayscale levels $g1$ and $g2$ will be referred to herein as an average grayscale level g_{ave} .

[0093] The hue determining section 340 determines the hue of the color represented by the input signal. Specifically, the hue determining section 340 determines the hue by using average grayscale levels r_{ave} , g_{ave} and b_{ave} . For example, if one of $r_{ave} > b_{ave}$, $g_{ave} > b_{ave}$ and $b_{ave} = 0$ is satisfied, then the hue determining section 340 determines that the hue is not blue. Also, if $b_{ave} > 0$ and $r_{ave} = g_{ave} = 0$ are satisfied, then the hue determining section 340 determines that the hue is blue.

[0094] For example, the hue determining section 340 determines the hue coefficient Hb using the average grayscale levels r_{ave} , g_{ave} and b_{ave} . The hue coefficient Hb is a function that varies according to the hue. Specifically, the hue coefficient Hb is a function that decreases as the blue component of the color to represent increases. Supposing function Max is a function representing the highest one of multiple variables, function $Second$ is a function representing the second highest one of the multiple variables, $M = MAX(r_{ave}, g_{ave}, b_{ave})$ and $S = Second(r_{ave}, g_{ave}, b_{ave})$, the hue coefficient Hb can be represented as $Hb = S/M$ ($b_{ave} \geq r_{ave}$, $b_{ave} \geq g_{ave}$ and $b_{ave} > 0$). More specifically, if $b_{ave} \geq g_{ave} \geq r_{ave}$ and $b_{ave} > 0$, then $Hb = g_{ave}/b_{ave}$. Also, if $b_{ave} \geq r_{ave} \geq g_{ave}$ and $b_{ave} > 0$, then $Hb = r_{ave}/b_{ave}$. Furthermore, if at least one of $b_{ave} < r_{ave}$, $b_{ave} < g_{ave}$ and $b_{ave} = 0$ is satisfied, then $Hb = 1$.

[0095] Next, the magnitudes of shift $\Delta s\alpha$ and $\Delta s\beta$ are calculated. In this case, the magnitude of shift $\Delta s\alpha$ is obtained as the product of $\Delta Y_b\alpha$ and the hue coefficient Hb , while the magnitude of shift $\Delta s\beta$ is obtained as the product of $\Delta Y_b\beta$ and the hue coefficient Hb . A multiplying section 350 multiplies the luminance level differences $\Delta Y_b\alpha$ and $\Delta Y_b\beta$ by the hue coefficient Hb , thereby obtaining the magnitudes of shift $\Delta s\alpha$ and $\Delta s\beta$.

[0096] Meanwhile, a grayscale-to-luminance converting section 360a carries out a grayscale-to-luminance conversion on the grayscale level $b1$, thereby obtaining a luminance level Y_{b1} , which can be calculated by the following equation:

$$Y_{b1} = b1^{2.2} \quad (\text{where } 0 \leq b1 \leq 1)$$

[0097] In the same way, another grayscale-to-luminance converting section 360b carries out a grayscale-to-luminance conversion on the grayscale level $b2$, thereby obtaining a luminance level Y_{b2} .

[0098] Next, an adding and subtracting section 370a adds the luminance level Y_{b1} and the magnitude of shift $\Delta s\alpha$ together, and then the sum is subjected to luminance-to-grayscale conversion by a luminance-to-grayscale converting section 380a, thereby obtaining a grayscale level $b1'$. On the other hand, another adding and subtracting section 370b subtracts the magnitude of shift $\Delta s\beta$ from the luminance level Y_{b2} , and then the remainder is subjected to luminance-to-grayscale conversion by another luminance-to-grayscale converting section 380b, thereby obtaining a grayscale level $b2'$. In general, if the input signal indicates that a pixel should represent an achromatic color at a middle grayscale, then the grayscale levels r , g and b indicated by the input signal are equal to each other. Consequently, in this LCD panel 200A, the luminance level Y_{b1}' is higher than the luminance levels Y_r and Y_g but the luminance level Y_{b2}' is lower than the luminance levels Y_r and Y_g . Also, the average of the luminance levels Y_{b1}' and Y_{b2}' is almost equal to the luminance levels Y_r and Y_g .

[0099] FIG. 9(b) shows a relation between the grayscale level of a blue subpixel as indicated by the input signal and that of the blue subpixel to be entered into the LCD panel 200A. In this case, the input signal indicates that an achromatic color should be represented and the hue coefficient Hb may be equal to one, for example. As the grayscale level difference section 320 gives the grayscale level differences $\Delta b\alpha$ and $\Delta b\beta$, the grayscale level $b1'$ is given by $b1 + \Delta b\alpha$ and the grayscale level $b2'$ is given by $b2 - \Delta b\beta$. As described above, using the grayscale levels $b1'$ and $b2'$, the blue subpixel $B1$ comes to have a luminance corresponding to the sum of the luminance level Y_{b1} and the magnitude of shift $\Delta s\alpha$ and the blue subpixel $B2$ comes to have a luminance corresponding to the difference between the luminance level Y_{b2} and the magnitude of shift $\Delta s\beta$.

[0100] In this manner, the grayscale levels **b1** and **b2** of the blue subpixels are changed based on the decision made by the hue determining section 340. If the hue determining section 340 has determined that the hue is not blue, the grayscale levels **b1** and **b2** of the blue subpixels are changed into different grayscale levels so that their relative luminance as viewed obliquely becomes closer to their relative luminance as viewed straight on. On the other hand, if the hue coefficient **Hb** is zero, the grayscale levels **b1** and **b2** of the blue subpixels as indicated by the input signal are output as the grayscale levels **b1'** and **b2'**.

[0101] Thus, if the hue determining section 340 has determined that the hue is blue, the grayscale levels **b1** and **b2** of the blue subpixels are output as they are without being changed. In that case, the grayscale level **b1** is equal to the grayscale level **b2**. In the LCD panel 200A, the average straight viewing luminance corresponding to the grayscale levels **b1'** and **b2'** is substantially equal to the one corresponding to the grayscale levels **b1** and **b2**.

[0102] As described above, the magnitudes of shift $\Delta s \alpha$ and $\Delta s \beta$ are represented by a function that includes the hue coefficient **Hb** as a parameter and change as the hue coefficient **Hb** varies.

[0103] Hereinafter, it will be described with reference to FIG. 10 how the blue correcting section 300b changes the hue coefficient. FIG. 10(a) is a schematic hue diagram and represents the color reproduction range of the LCD panel 200A as a regular triangle. For example, if the grayscale level as indicated by the input signal satisfies $r_{ave} = g_{ave} = b_{ave}$, the hue coefficient **Hb** becomes one. Likewise, if the grayscale level as indicated by the input signal satisfies $0 = r_{ave} < g_{ave} = b_{ave}$, then the hue coefficient **Hb** also becomes one. On the other hand, if $0 = r_{ave} = g_{ave} < b_{ave}$, then the hue coefficient **Hb** becomes zero.

[0104] FIG. 10(b) shows a relation between the grayscale level **b** as indicated by the input signal and the corrected grayscale level **b'** of the blue subpixel in a situation where the hue coefficient **Hb**=1. In this case, the grayscale level **b1'** indicates that of the bright blue subpixel of one of two adjacent pixels (e.g., the blue subpixel **B1** of the pixel **P1** shown in FIGS. 7(a) and 7(b)), while the grayscale level **b2'** indicates that of the dark blue subpixel of the other pixel (e.g., the blue subpixel **B2** of the pixel **P2** shown in FIGS. 7(a) and 7(b)).

[0105] As the grayscale level **b** increases, the grayscale level **b1'** increases but the grayscale level **b2'** remains zero when the grayscale level **b** is relatively low. But once the grayscale level **b1'** has reached the highest grayscale level with the increase in the grayscale level **b**, the grayscale level **b2'** starts to increase soon. As can be seen, unless the grayscale level **b** is the lowest grayscale level or the highest grayscale level, the grayscale level **b1'** is different from the grayscale level **b2'**. By having the correcting section 300A make such a correction, the viewing angle characteristic as viewed obliquely can be improved.

[0106] FIG. 10(c) shows a relation between the grayscale level **b** as indicated by the input signal and the corrected grayscale level **b'** of the blue subpixel when the hue coefficient **Hb**=0. In a situation where the hue of the color indicated by the input signal is on the line **WB** shown in FIG. 10(a), if the blue correcting section 300b shown in FIG. 1(a) has made a correction, the viewer may sense that the luminance of the bright blue subpixel belonging to one pixel is different from that of the dark blue subpixel belonging to the other pixel. That is why the blue correcting section 300b does not make any correction. In that case, the grayscale levels **b1'** and **b2'** of the respective blue subpixels of one of two adjacent pixels (e.g., the pixel **P1** shown in FIGS. 7(a) and 7(b)) and the other pixel (e.g., the pixel **P2** shown in FIGS. 7(a) and 7(b)) are equal to the grayscale level **b** as indicated by the input signal.

[0107] For example, if the grayscale levels (r_{ave} , g_{ave} , b_{ave}) of red, green and blue subpixels are (128, 128, 128) with respect to the highest grayscale level of 255, the hue coefficient **Hb** is one, and therefore, the magnitudes of shift $\Delta s \alpha$ and $\Delta s \beta$ become $\Delta Y_b \alpha$ and $\Delta Y_b \beta$, respectively. On the other hand, if (r_{ave} , g_{ave} , b_{ave}) are (0, 0, 128), the hue coefficient **Hb** becomes zero, and therefore, the magnitudes of shift $\Delta s \alpha$ and $\Delta s \beta$ become zero. Furthermore, if (r_{ave} , g_{ave} , b_{ave}) are (64, 64, 128), which are halfway between these two situations, then **Hb** = 0.5, and the magnitudes of shift $\Delta s \alpha$ and $\Delta s \beta$ become $0.5 \times \Delta Y_b \alpha$ and $0.5 \times \Delta Y_b \beta$, respectively, which are half as large as when **Hb** = 1.0. In this manner, the magnitudes of shift $\Delta S \alpha$ and $\Delta S \beta$ change continuously according to the hue indicated by the input signal, and a sudden change of the display characteristic can be minimized. As described above, the blue correcting section 300b changes the magnitude of shift according to the color indicated by the input signal. As a result, not only can the viewing angle characteristic be improved but also can the decrease in resolution be minimized as well. In the blue correcting section 300b shown in FIG. 8, the grayscale level section 320 calculates a grayscale level difference corresponding to the average grayscale level b_{ave} , and the magnitude of shift can be changed easily according to the hue by using the grayscale level difference. FIG. 9(b) is a graph showing a result obtained when the hue coefficient **Hb** is one. If the hue coefficient **Hb** is zero, on the other hand, then the grayscale level **b1** (= **b2**) as indicated by the input signal becomes equal to the output grayscale levels **b1'** and **b2'**.

[0108] Thus, the liquid crystal display device 100A of this preferred embodiment can minimize the color shift by changing the hue coefficient **Hb** in this manner. As for the relation between the hue coefficients and the liquid crystal display devices of Comparative Examples 1 and 2, the hue coefficient **Hb** = 0 is associated with the liquid crystal display device of Comparative Example 1, while the hue coefficient **Hb** = 1 is associated with the liquid crystal display device of Comparative Example 2.

[0109] Hereinafter, it will be described with reference to FIG. 11 how the obliquely viewing grayscale changes with

the hue coefficient H_b . FIG. 11(a) shows a relation between the grayscale level (i.e., reference grayscale level) b of a blue subpixel as indicated by the input signal and corrected grayscale levels b_1' and b_2' thereof when the hue coefficient H_b is one. For example, if the grayscale level b is grayscale level 186 ($= 0.5^{1/2.2} \times 255$) that corresponds to a half of the highest luminance, then the corrected grayscale levels b_1' and b_2' are grayscale levels 255 and 0, respectively. On the other hand, if the grayscale level b exceeds 186, then the grayscale level b_1' becomes 255 and the grayscale level b_2' increases so that the average luminance of the blue subpixels B_1 and B_2 corresponds to the grayscale level b . FIG. 11(b) shows how the obliquely viewing grayscale changes with the reference grayscale level. In FIG. 11(b), the obliquely viewing grayscale obtained by correcting the grayscale level with a hue coefficient $H_b = 1$ is indicated by the solid curve, and the obliquely viewing grayscale when the grayscale level is not corrected (i.e., when the hue coefficient $H_b = 0$) is indicated by the dashed curve for your reference. As can be seen from FIG. 11(b), by correcting the grayscale level with the hue coefficient $H_b = 1$, the whitening phenomenon can be reduced significantly. FIG. 11(b) corresponds to FIG. 6(c). [0110] On the other hand, FIG. 11(c) shows a relation between the grayscale level (i.e., reference grayscale level) b of a blue subpixel as indicated by the input signal and corrected grayscale levels b_1' and b_2' thereof when the hue coefficient H_b is 0.5. In this case, as the grayscale level b increases, not only the grayscale level b_1' but also the grayscale level b_2' increase as well. However, the grayscale level b_1' is greater than the grayscale level b_2' . Also, the grayscale levels b_1' and b_2' are proportional to the grayscale level b .

[0111] If the hue coefficient H_b is 0.5, the grayscale level b when the grayscale level b_1' reaches the highest grayscale level 255 is greater than 186. Once the grayscale level b_1' has reached the highest grayscale level 255, the grayscale level b_2' starts to increase at an even higher rate so that the average luminance of the blue subpixels B_1 and B_2 corresponds to the grayscale level b . FIG. 11(d) shows how the obliquely viewing grayscale changes with the reference grayscale level. In FIG. 11(d), the obliquely viewing grayscale obtained by correcting the grayscale level with a hue coefficient $H_b=0.5$ is indicated by the dotted curve, and the obliquely viewing grayscale when the grayscale level is not corrected (i.e., when the hue coefficient $H_b = 0$) is indicated by the dashed curve for your reference. As can be seen from FIG. 11(d), by correcting the grayscale level with, the hue coefficient $H_b = 0.5$, the whitening phenomenon can be reduced to a certain degree. FIG. 11(d) corresponds to FIG. 7(c). In conclusion, it can be said that by changing the hue coefficient H_b within the range of 0 to 1, the obliquely viewing grayscale of the liquid crystal display device 100A can be an arbitrary value between those of the liquid crystal display devices of Comparative Examples 1 and 2 as can be seen from FIGS. 7 (c), 11(b) and 11(d).

[0112] Although the configuration of the blue correcting section 300b has been described, the red correcting section 300r and the green correcting section 300g also have a similar configuration. In the red correcting section 300r, for example, the hue determining section 340 also determines the hue of the color indicated by the input signal. Specifically, the hue determining section 340 determines a hue coefficient H_r by using the average grayscale levels r_{ave} , g_{ave} and b_{ave} . The hue coefficient H_r is a function that varies according to the hue. The hue coefficient H_r can be represented as $H_r = S/M$ ($r_{ave} \geq g_{ave}$, $r_{ave} \geq b_{ave}$ and $r_{ave} > 0$). Specifically, if $r_{ave} \geq g_{ave} \geq b_{ave}$ and $r_{ave} > 0$, then $H_r = g_{ave}/r_{ave}$. Also, if $r_{ave} \geq b_{ave} \geq g_{ave}$ and $r_{ave} > 0$, then $H_r = b_{ave}/r_{ave}$. Furthermore, if at least one of $r_{ave} < g_{ave}$, $r_{ave} < b_{ave}$ and $r_{ave} = 0$ is satisfied, then $H_r=1$.

[0113] Likewise, in the green correcting section 300g, the hue determining section 340 also determines the hue of the color indicated by the input signal. The hue determining section 340 determines a hue coefficient H_g by using the average grayscale levels r_{ave} , g_{ave} and b_{ave} . The hue coefficient H_g is a function that varies according to the hue. The hue coefficient H_g can be represented as $H_g = S/M$ ($g_{ave} \geq r_{ave}$, $g_{ave} \geq b_{ave}$ and $g_{ave} > 0$). Specifically, if $g_{ave} \geq r_{ave} \geq b_{ave}$ and $g_{ave} > 0$, then $H_g = r_{ave}/g_{ave}$. Also, if $g_{ave} \geq b_{ave} \geq r_{ave}$ and $g_{ave} > 0$, then $H_g = b_{ave}/g_{ave}$. Furthermore, if at least one of $g_{ave} < r_{ave}$, $g_{ave} < b_{ave}$ and $g_{ave} = 0$ is satisfied, then $H_g=1$.

[0114] As described above, in the correcting section 300A, the red, green and blue correcting sections 300r, 300g and 300b make corrections using the hue coefficients H_r , H_g and H_b , respectively. If the grayscale levels of red, green and blue subpixels as indicated by the input signal satisfy $r_{ave} = g_{ave} = b_{ave} \neq 0$, corrections are made on the grayscale levels of all of the red, green and blue subpixels. However, if the grayscale levels of red, green and blue subpixels as indicated by the input signal satisfy $r_{ave} = g_{ave} = b_{ave} = 0$, correction is not made on the grayscale level of any of the red, green and blue subpixels. Furthermore, if the grayscale levels of red, green and blue subpixels as indicated by the input signal satisfy $r_{ave} = g_{ave} > b_{ave} \neq 0$, corrections are made on the grayscale levels of all of the red, green and blue subpixels. Also, if the grayscale levels of the red, green and blue subpixels satisfy $r_{ave} = g_{ave} > b_{ave} = 0$, corrections are made on the grayscale levels of the red and green subpixels. Furthermore, if the grayscale levels of red, green and blue subpixels as indicated by the input signal satisfy $0 \neq r_{ave} = g_{ave} < b_{ave}$, corrections are made on the grayscale levels of all of the red, green and blue subpixels. On the other hand, if the grayscale levels of red, green and blue subpixels as indicated by the input signal satisfy $0 = r_{ave} = g_{ave} < b_{ave}$, corrections are not made on the grayscale level of any of the red, green and blue subpixels. As can be seen, if at least two of the grayscale levels of red, green and blue subpixels as indicated by the input signal are not equal to zero, at least one of the red, green and blue correcting sections 300r, 300g and 300b makes a correction.

[0115] For example, if $r_{ave} > g_{ave} = b_{ave} > 0$, then the hue coefficient $H_r = S/M$ and the hue coefficients H_g and H_b

are one. Specifically, if $(r_{ave}, g_{ave}, b_{ave}) = (100, 50, 50)$, the hue coefficients **Hr**, **Hg** and **Hb** become 0.5, 1 and 1 as shown in FIG. 12. As a result, the difference in grayscale level between the respective subpixels can be almost ironed out and the chromaticity difference can be minimized.

[0116] The following Table 4 shows the average grayscale level of red subpixels (with the grayscale levels of bright and dark red subpixels) and the hue coefficient **Hr**, that of green subpixels (with the grayscale levels of bright and dark green subpixels) and the hue coefficient **Hg**, that of blue subpixels (with the grayscale levels of bright and dark blue subpixels) and the hue coefficient **Hb**, viewing angle directions, chromaticity coordinates **x** and **y**, luminances **Y** and chromaticity differences $\Delta u'v'$.

[0117]

Table 4

R		Hr	G		Hg	B		Hb	Viewing angle direction	x	y	Y	$\Delta u'v'$
100			50			50			Straight	0.446	0.309	0.050	--
100	100	0	50	50	0	50	50	0	Obliquely 60°	0.318	0.278	0.176	0.092
120	73	0.5	69	0	1	69	0	1	Obliquely 60°	0.376	0.290	0.139	0.050

[0118] In the same way, if $g_{ave} > r_{ave} = b_{ave} > 0$ (e.g., if $(r_{ave}, g_{ave}, b_{ave}) = (50, 100, 50)$), the chromaticity difference can be minimized by setting the hue coefficients **Hr**, **Hg** and **Hb** to be 1, 0.5 and 1, respectively. Also, if $b_{ave} > r_{ave} = g_{ave} > 0$ (e.g., if $(r_{ave}, g_{ave}, b_{ave}) = (50, 50, 100)$), the chromaticity difference can be minimized by setting the hue coefficients **Hr**, **Hg** and **Hb** to be 1, 1, and 0.5, respectively. In this manner, by using the functions **Max** and **Second**, the color shift can be reduced easily. As described above, the liquid crystal display device **100A** of this preferred embodiment includes the red, green and blue correcting sections **300r**, **300g** and **300b** and controls the luminances of the respective subpixels based on the grayscale levels of red, green and blue subpixels, thereby improving the viewing angle characteristic and minimizing the color shift at the same time.

[0119] In the foregoing description, the hue coefficients **Hr**, **Hg** and **Hb** for use in the red, green and blue correcting sections **300r**, **300g** and **300b**, respectively, are continuously variable within the range of zero to one. For example, if $MAX(r_{ave}, g_{ave}, b_{ave}) = b_{ave}$, then the hue coefficient **Hb** can be represented as $Hb = SECOND(r_{ave}, g_{ave}, b_{ave}) / MAX(r_{ave}, g_{ave}, b_{ave})$. However, this is only an example of the present invention. Optionally, at least one of the hue coefficients **Hr**, **Hg** and **Hb** may be binarized. For example, if the hue coefficient **Hb** is binarized into zero or one, at least one of the hue coefficients **Hr** and **Hg** of the red and green correcting sections **300r** and **300g** may be variable within the range of zero to one.

[0120] Alternatively, at least one of the hue coefficients **Hr**, **Hg** and **Hb** may be fixed at one. For example, the hue coefficient **Hb** may be fixed at one, while at least one of the hue coefficients **Hr** and **Hg** for use in the red and green correcting sections **300r** and **300g** may vary within the range of zero to one.

[0121] Still alternatively, the hue coefficient **Hb** may have a binarized value of zero or one according to the hue, while the hue coefficients **Hr** and **Hg** may be fixed at zero.

[0122] Hereinafter, a relation between the hue of the color represented by a pixel and the hue coefficient **Hb** will be described with reference to FIG. 13 and Table 5. In the following example, the hue coefficient **Hb** is variable in the blue correcting section **300b** into zero or one according to the hue, but the hue coefficients **Hr** and **Hg** are fixed at zero in the red and green correcting sections **300r** and **300g**.

[0123] FIG. 13(a) schematically illustrates the hues of the LCD panel **200A**. As shown in FIG. 13(a), the hue coefficient **Hb** varies with the hue.

[0124] If the input signal indicates that a pixel should represent the color blue, the chromaticity difference when the hue coefficient **Hb** is zero is smaller than the one when the hue coefficient **Hb** is one. On the other hand, if the input signal indicates that a pixel should represent the color magenta or cyan, the chromaticity difference when the hue coefficient **Hb** is zero is also smaller than the one when the hue coefficient **Hb** is one. That is why if the input signal indicates that a pixel should represent the color blue, magenta or cyan, the hue coefficient **Hb** becomes equal to zero. For example, if the average grayscale levels $(r_{ave}, g_{ave}, b_{ave})$ of red, green and blue subpixels are $(64, 64, 128)$, $(128, 64, 128)$ or $(64, 128, 128)$, then the hue coefficient **Hb** becomes equal to zero. FIG. 13(b) shows how the grayscale levels **b1'** and **b2'** change if the hue coefficient **Hb** is equal to zero. In that case, the grayscale level **b1'** is equal to the grayscale level **b2'**. By setting the hue coefficient **Hb** to be zero in this manner if a pixel should represent the color blue, magenta or cyan, the chromaticity difference $\Delta u'v'$ can be minimized.

[0125] On the other hand, if the input signal indicates that a pixel should represent the color red, the chromaticity

difference when the hue coefficient **Hb** is one is smaller than the one when the hue coefficient **Hb** is zero. On the other hand, if the input signal indicates that a pixel should represent the color yellow or green, the chromaticity difference when the hue coefficient **Hb** is one is also smaller than the one when the hue coefficient **Hb** is zero. That is why if the input signal indicates that a pixel should represent the color red, yellow or green, the hue coefficient **Hb** becomes equal to one. For example, if the average grayscale levels (r_{ave} , g_{ave} , b_{ave}) of red, green and blue subpixels are (255, 128, 128), (255, 255, 128) or (128, 255, 128), then the hue coefficient **Hb** becomes equal to one. FIG. 13(c) shows how the grayscale levels **b1'** and **b2'** change if the hue coefficient **Hb** is equal to one. In that case, the grayscale level **b1'** is different from the grayscale level **b2'**. By setting the hue coefficient **Hb** to be one this manner if a pixel should represent the color red, yellow or green, the chromaticity difference $\Delta u' v'$ can be minimized.

[0126] For example, if the average grayscale level b_{ave} is equal to $\text{MAX}(r_{ave}, g_{ave}, b_{ave})$ and if the difference between $\text{MAX}(r_{ave}, g_{ave}, b_{ave})$ and b_{ave} is smaller than a predetermined value, then the hue coefficient **Hb** may be set to be zero. On the other hand, if the average grayscale level b_{ave} is smaller than $\text{MAX}(r_{ave}, g_{ave}, b_{ave})$ and if the difference between $\text{MAX}(r_{ave}, g_{ave}, b_{ave})$ and b_{ave} is greater than the predetermined value, then the hue coefficient **Hb** may be set to be one.

[0127] The following Table 5 shows the colors to be represented by a pixel, the average grayscale levels of red and green subpixels, the average grayscale levels of blue subpixels (with the grayscale levels of bright and dark blue subpixels), the hue coefficient **Hb**, viewing angle directions, chromaticity coordinates x and y , luminances Y and chromaticity differences $\Delta u' v'$. In this case, the average grayscale level b_{ave} of the input signal is 128. If the hue coefficient **Hb** is zero, then the grayscale levels of the bright and dark blue subpixels both become 128. On the other hand, if the hue coefficient **Hb** is one, the grayscale levels of the bright and dark blue subpixels become 175 ($= (2 \times (128/255)^{2.2})^{1/2.2} \times 255$) and 0, respectively.

[0128]

Table 5

	R	G	B	Hb	Viewing angle direction	x	y	Y	$\Delta u' v'$	
Blue	64	64	128		Straight	0.197	0.158	0.069	--	
			128	128	0	Obliquely 60°	0.233	0.216	0.203	0.063
			175	0	1	Obliquely 60°	0.259	0.260	0.190	0.102
Magenta	128	64	128		Straight	0.296	0.194	0.107	--	
			128	128	0	Obliquely 60°	0.294	0.231	0.253	0.040
			175	0	1	Obliquely 60°	0.331	0.271	0.240	0.070
Red	255	128	128		Straight	0.445	0.309	0.394	--	
			128	128	0	Obliquely 60°	0.388	0.303	0.539	0.043
			175	0	1	Obliquely 60°	0.422	0.336	0.525	0.035
Yellow	255	255	128		Straight	0.377	0.429	0.905	--	
			128	128	0	Obliquely 60°	0.358	0.387	0.932	0.019
			175	0	1	Obliquely 60°	0.379	0.419	0.919	0.006
Green	128	255	128		Straight	0.281	0.465	0.730	--	
			128	128	0	Obliquely 60°	0.285	0.402	0.784	0.028
			175	0	1	Obliquely 60°	0.302	0.444	0.770	0.017
Cyan	64	128	128		Straight	0.219	0.293	0.181	--	
			128	128	0	Obliquely 60°	0.240	0.292	0.340	0.015
			175	0	1	Obliquely 60°	0.262	0.344	0.326	0.038

[0129] By changing the hue coefficient **Hb** according to the hue of the color to be represented by a pixel in this manner, the color shift can be minimized.

[0130] In the example described above, the hue coefficients **Hr** and **Hg** are fixed at zero in the red and green correcting sections 300r and 300g, while the hue coefficient **Hb** changes into zero or one according to the hue in the blue correcting section 300b. However, the present invention is in no way limited to that specific preferred embodiment. Alternatively,

the hue coefficients **Hg** and **Hb** may be fixed at zero in the green and blue correcting sections **300g** and **300b**, while the hue coefficient **Hr** may change into zero or one according to the hue in the red correcting section **300r**.

[0131] Hereinafter, a relation between the hue of the color represented by a pixel and the hue coefficient **Hr** will be described with reference to FIG. **14** and Table 6.

5 **[0132]** FIG. **14(a)** schematically illustrates the hues of the LCD panel **200A**. As shown in FIG. **14 (a)**, the hue coefficient **Hr** varies with the hue.

[0133] If the input signal indicates that a pixel should represent the color red, the chromaticity difference when the hue coefficient **Hr** is zero is smaller than the one when the hue coefficient **Hr** is one. On the other hand, if the input signal indicates that a pixel should represent the color magenta or yellow, the chromaticity difference when the hue coefficient **Hr** is zero is also smaller than the one when the hue coefficient **Hr** is one. That is why if the input signal indicates that a pixel should represent the color red, magenta or yellow, the hue coefficient **Hr** becomes equal to zero. For example, if the average grayscale levels (r_{ave} , g_{ave} , b_{ave}) of red, green and blue subpixels are (128, 64, 64), (128, 64, 128) or (128, 128, 64), then the hue coefficient **Hr** becomes equal to zero. FIG. **14(b)** shows how the grayscale levels **r1'** and **r2'** change if the hue coefficient **Hr** is equal to zero. In that case, the grayscale level **r1'** is equal to the grayscale level **r2'**. By setting the hue coefficient **Hr** to be zero in this manner if a pixel should represent the color red, magenta or yellow, the chromaticity difference $\Delta u'v'$ can be minimized.

[0134] On the other hand, if the input signal indicates that a pixel should represent the color blue, the chromaticity difference when the hue coefficient **Hr** is one is smaller than the one when the hue coefficient **Hr** is zero. On the other hand, if the input signal indicates that a pixel should represent the color green or cyan, the chromaticity difference when the hue coefficient **Hr** is one is also smaller than the one when the hue coefficient **Hr** is zero. That is why if the input signal indicates that a pixel should represent the color blue, green or cyan, the hue coefficient **Hr** becomes equal to one. For example, if the average grayscale levels (r_{ave} , g_{ave} , b_{ave}) of red, green and blue subpixels are (128, 128, 255), (128, 255, 128) or (128, 255, 255), then the hue coefficient **Hr** becomes equal to one. FIG. **14(c)** shows how the grayscale levels **r1'** and **r2'** change if the hue coefficient **Hr** is equal to one. In that case, the grayscale level **r1'** is different from the grayscale level **r2'**. By setting the hue coefficient **Hr** to be one in this manner if a pixel should represent the color blue, green or cyan, the chromaticity difference $\Delta u'v'$ can be minimized.

[0135] For example, if the average grayscale level r_{ave} is equal to MAX (r_{ave} , g_{ave} , b_{ave}) and if the difference between MAX (r_{ave} , g_{ave} , b_{ave}) and r_{ave} is smaller than a predetermined value, then the hue coefficient **Hr** may be set to be zero. On the other hand, if the average grayscale level r_{ave} is smaller than MAX (r_{ave} , g_{ave} , b_{ave}) and if the difference between MAX (r_{ave} , g_{ave} , b_{ave}) and r_{ave} is greater than the predetermined value, then the hue coefficient **Hr** may be set to be one.

[0136] The following Table 6 shows the colors to be represented by a pixel, the average grayscale levels of red subpixels (with the grayscale levels of bright and dark red subpixels), the hue coefficient **Hr**, the average grayscale levels of green and blue subpixels, viewing angle directions, chromaticity coordinates **x** and **y**, luminances **Y** and chromaticity differences $\Delta u'v'$. In this case, the average grayscale level r_{ave} of the input signal is 128. If the hue coefficient **Hr** is zero, then the grayscale levels of the bright and dark red subpixels both become 128. On the other hand, if the hue coefficient **Hr** is one, the grayscale levels of the bright and dark red subpixels become 175 and 0, respectively.

[0137]

Table 6

	R		Hr	G	B	Viewing angle direction	x	y	Y	$\Delta u'v'$
Blue	128			128	255	Straight	0.197	0.159	0.315	--
	128	128	0			Obliquely 60°	0.237	0.220	0.447	0.067
	175	0	1			Obliquely 60°	0.222	0.216	0.424	0.061
Magenta	128			64	128	Straight	0.296	0.194	0.107	--
	128	128	0			Obliquely 60°	0.294	0.231	0.253	0.040
	175	0	1			Obliquely 60°	0.269	0.225	0.231	0.048
Red	128			64	64	Straight	0.446	0.309	0.086	--
	128	128	0			Obliquely 60°	0.349	0.287	0.232	0.070
	175	0	1			Obliquely 60°	0.319	0.283	0.210	0.092
Yellow	128			128	64	Straight	0.377	0.358	0.199	--
	128	128	0			Obliquely 60°	0.332	0.358	0.369	0.037
	175	0	1			Obliquely 60°	0.308	0.361	0.346	0.044

(continued)

	R		Hr	G	B	Viewing angle direction	x	y	Y	$\Delta u' v'$					
5	Green		128		255	128	Straight	0.281	0.465	0.730	--				
	128	128	0	Obliquely 60°								0.285	0.402	0.784	0.028
	175	0	1	Obliquely 60°								0.271	0.405	0.761	0.025
10	Cyan		128		255	255	Straight	0.220	0.293	0.826	--				
	128	128	0	Obliquely 60°								0.246	0.316	0.840	0.021
	175	0	1	Obliquely 60°								0.234	0.316	0.818	0.016

[0138] By changing the hue coefficient **Hr** according to the hue of the color to be represented by a pixel in this manner, the color shift can be minimized.

[0139] Although it will not be described in detail herein to avoid redundancies, the hue coefficients **Hr** and **Hb** may be fixed at zero in the red and blue correcting sections **300r** and **300b**, while the hue coefficient **Hg** may change into zero or one according to the hue in the green correcting section **300g**. In that case, if a pixel should represent the color green, yellow or cyan, the color shift can be minimized by setting the hue coefficient **Hg** to be zero. On the other hand, if a pixel should represent the color blue, magenta or red, the color shift can be minimized by setting the hue coefficient **Hg** to be one.

[0140] In the examples described above, the hue coefficient is supposed to change in one of the red, green and blue correcting sections **300r**, **300g** and **300b**. However, the present invention is in no way limited to that specific preferred embodiment. Optionally, the hue coefficients may also change in two of the red, green and blue correcting sections **300r**, **300g** and **300b**.

[0141] Hereinafter, a relation between the hue of the color represented by a pixel and the hue coefficients **Hr** and **Hb** will be described with reference to FIG. 15 and Table 7. In the following example, the hue coefficients **Hr** and **Hb** change into zero or one according to the hue in the red and blue correcting sections **300r** and **300b**, but the hue coefficient **Hg** is fixed at zero in the green correcting section **300g**.

[0142] FIG. 15(a) schematically illustrates the hues of the LCD panel **200A**. As shown in FIG. 15(a), the hue coefficients **Hr** and **Hb** vary with the hue.

[0143] Specifically, if the input signal indicates that a pixel should represent the color magenta, the chromaticity difference when the hue coefficients **Hr** and **Hb** are both zero is smaller than the one when the hue coefficients **Hr** and **Hb** are any other combination. That is why the hue coefficients **Hr** and **Hb** are both equal to zero, the grayscale level **r1'** is equal to the grayscale level **r2'**, and the grayscale level **b1'** is equal to the grayscale level **b2'**. FIG. 15(b) shows how the grayscale levels **r1'**, **r2'**, **b1'** and **b2'** change if the hue coefficients **Hr** and **Hb** are both equal to zero. For example, if the average grayscale levels (r_{ave} , g_{ave} , b_{ave}) of red, green and blue subpixel are (128, 64, 128), the chromaticity difference can be minimized by setting both of the hue coefficients **Hr** and **Hb** to be zero.

[0144] On the other hand, if the input signal indicates that a pixel should represent the color red or yellow, the chromaticity difference when the hue coefficients **Hr** and **Hb** are zero and one, respectively, is smaller than the one when the hue coefficients **Hr** and **Hb** are any other combination. That is why the hue coefficients **Hr** and **Hb** are equal to zero and one, respectively, the grayscale level **r1'** is equal to the grayscale level **r2'**, and the grayscale level **b1'** is different from the grayscale level **b2'**. FIG. 15(c) shows how the grayscale levels **r1'**, **r2'**, **b1'** and **b2'** change if the hue coefficients **Hr** and **Hb** are equal to zero and one, respectively. For example, if the average grayscale levels (r_{ave} , g_{ave} , b_{ave}) of red, green and blue subpixel are (128, 64, 64) or (128, 128, 64), the chromaticity difference can be minimized by setting the hue coefficients **Hr** and **Hb** to be zero and one, respectively.

[0145] Furthermore, if the input signal indicates that a pixel should represent the color blue or cyan, the chromaticity difference when the hue coefficients **Hr** and **Hb** are one and zero, respectively, is smaller than the one when the hue coefficients **Hr** and **Hb** are any other combination. That is why the hue coefficients **Hr** and **Hb** are equal to one and zero, respectively, the grayscale level **r1'** is different from the grayscale level **r2'**, and the grayscale level **b1'** is equal to the grayscale level **b2'**. FIG. 15(d) shows how the grayscale levels **r1'**, **r2'**, **b1'** and **b2'** change if the hue coefficients **Hr** and **Hb** are equal to one and zero, respectively. For example, if the average grayscale levels (r_{ave} , g_{ave} , b_{ave}) of red, green and blue subpixel are (64, 64, 128) or (64, 128, 128), the chromaticity difference can be minimized by setting the hue coefficients **Hr** and **Hb** to be one and zero, respectively.

[0146] Furthermore, if the input signal indicates that a pixel should represent the color green, the chromaticity difference when the hue coefficients **Hr** and **Hb** are both one is smaller than the one when the hue coefficients **Hr** and **Hb** are any other combination. That is why the hue coefficients **Hr** and **Hb** are both equal to one, the grayscale level **r1'** is different from the grayscale level **r2'**, and the grayscale level **b1'** is different from the grayscale level **b2'**. FIG. 15(e) shows how the grayscale levels **r1'**, **r2'**, **b1'** and **b2'** change if the hue coefficients **Hr** and **Hb** are both one. For example, if the

EP 2 378 509 A1

average grayscale levels (r_{ave} , g_{ave} , b_{ave}) of red, green and blue subpixel are (64, 128, 64), the chromaticity difference can be minimized by setting both of the hue coefficients **Hr** and **Hb** to be one.

[0147] For example, if the average grayscale level r_{ave} is equal to $\text{MAX}(r_{ave}, g_{ave}, b_{ave})$ and if the difference between $\text{MAX}(r_{ave}, g_{ave}, b_{ave})$ and r_{ave} is smaller than a predetermined value, then the hue coefficient **Hr** may be set to be zero.

On the other hand, if the average grayscale level r_{ave} is smaller than $\text{MAX}(r_{ave}, g_{ave}, b_{ave})$ and if the difference between $\text{MAX}(r_{ave}, g_{ave}, b_{ave})$ and r_{ave} is greater than the predetermined value, then the hue coefficient **Hr** may be set to be one.

Also, if the average grayscale level b_{ave} is equal to $\text{MAX}(r_{ave}, g_{ave}, b_{ave})$ and if the difference between $\text{MAX}(r_{ave}, g_{ave}, b_{ave})$ and b_{ave} is smaller than a predetermined value, then the hue coefficient **Hb** may be set to be zero.

On the other hand, if the average grayscale level b_{ave} is smaller than $\text{MAX}(r_{ave}, g_{ave}, b_{ave})$ and if the difference between $\text{MAX}(r_{ave}, g_{ave}, b_{ave})$ and b_{ave} is greater than the predetermined value, then the hue coefficient **Hb** may be set to be one.

[0148] The following Table 7 shows the colors to be represented by a pixel, the grayscale levels of red subpixels (with the grayscale levels of bright and dark red subpixels), the hue coefficient **Hr**, the average grayscale levels of a green subpixel, the average grayscale levels of blue subpixels (with the grayscale levels of bright and dark blue subpixels), the hue coefficient **Hb**, viewing angle directions, chromaticity coordinates **x** and **y**, luminances **Y** and chromaticity differences $\Delta u'v'$.

In this case, the average grayscale levels r_{ave} and b_{ave} of the input signal are 64 or 128. If the hue coefficients **Hr** and **Hb** are zero, then the grayscale levels of the bright and dark subpixels both become 64 or 128.

On the other hand, if the hue coefficients **Hr** and **Hb** are one, the grayscale levels of the bright and dark subpixels become 88 ($= (2 \times (64/255)^{2.2})^{1/2.2} \times 255$) and zero when the average grayscale level is 64 and the grayscale levels of the bright and dark subpixels become 175 ($= (2 \times (128/255)^{2.2})^{1/2.2} \times 255$) and zero when the average grayscale level is 128.

[0149]

Table 7

	R		Hr	G	B		Hb	Viewing angle direction	x	Y	Y	$\Delta u'v'$
Blue	64			64	128			Straight	0.197	0.159	0.069	--
	64	64	0		128	128	0	Obliquely 60°	0.233	0.216	0.203	0.063
					175	0	1		0.259	0.260	0.190	0.102
	88	0	1		128	128	0	Obliquely 60°	0.213	0.211	0.190	0.056
					175	0	1		0.235	0.256	0.177	0.096
Magenta	128			64	128			Straight	0.296	0.194	0.107	--
	128	128	0		128	128	0	Obliquely 60°	0.294	0.231	0.253	0.040
					175	0	1		0.331	0.271	0.240	0.070
	175	0	1		128	128	0	Obliquely 60°	0.269	0.225	0.231	0.048
					175	0	1		0.302	0.267	0.217	0.070
Red	128			64	64			Straight	0.446	0.309	0.086	--
	128	128	0		64	64	0	Obliquely 60°	0.349	0.287	0.232	0.070
					88	0	1		0.391	0.333	0.223	0.055
	175	0	1		64	64	0	Obliquely 60°	0.319	0.283	0.210	0.092
					88	0	1		0.360	0.334	0.201	0.078
Yellow	128			128	64			Straight	0.377	0.429	0.199	--
	128	128	0		64	64	0	Obliquely 60°	0.332	0.358	0.369	0.037
					88	0	1		0.362	0.404	0.360	0.012
	175	0	1		64	64	0	Obliquely 60°	0.308	0.361	0.346	0.044
					88	0	1		0.336	0.411	0.338	0.023

(continued)

	R		Hr	G	B		Hb	Viewing angle direction	x	Y	Y	$\Delta u'v'$
5	64			128	64			Straight	0.281	0.466	0.160	--
	64	64	0		64	64	0	Obliquely 60°	0.273	0.364	0.319	0.046
					88	0	1		0.297	0.421	0.310	0.024
10	88	0	1		64	64	0	Obliquely 60°	0.254	0.366	0.306	0.044
					88	0	1		0.276	0.426	0.297	0.016
	64			128	128			Straight	0.219	0.293	0.181	--
15	64	64	0		128	128	0	Obliquely 60°	0.240	0.292	0.340	0.015
					175	0	1		0.262	0.344	0.326	0.038
	88	0	1		128	128	0	Obliquely 60°	0.224	0.291	0.327	0.004
					175	0	1		0.244	0.345	0.313	0.033

[0150] As described above, if a pixel should represent the color magenta, the chromaticity difference $\Delta u'v'$ can be minimized by setting both of the hue coefficients **Hr** and **Hb** to be zero. On the other hand, if a pixel should represent the color red or yellow, the chromaticity difference $\Delta u'v'$ can be minimized by setting the hue coefficients **Hr** and **Hb** to be zero and one, respectively.

[0151] Also, if a pixel should represent the color blue or cyan, the chromaticity difference $\Delta u'v'$ can be minimized by setting the hue coefficients **Hr** and **Hb** to be one and zero, respectively. Furthermore, if a pixel should represent the color green, the chromaticity difference $\Delta u'v'$ can be minimized by setting both of the hue coefficients **Hr** and **Hb** to be one. By changing the hue coefficients **Hr** and **Hb** according to the hue of the color to be represented by a pixel in this manner, the color shift can be minimized. As already mentioned, at least one of the hue coefficients **Hr**, **Hg** and **Hb** may be binarized.

[0152] If subpixels, other than the subpixel to turn ON, are in OFF state and if there is a significant difference in luminance between those OFF-state subpixels and the subpixel that has been turned ON, a decrease in resolution is easily sensible. In this liquid crystal display device **100A**, however, if the grayscale levels of red, green and blue subpixels as indicated by the input signal are (0, 0, 128), for example, then the hue coefficient **Hb** is zero, the grayscale level of the blue subpixel as indicated by the input signal does not change, and the luminances of the blue subpixels **B1** and **B2** become equal to each other. By preventing the correcting section **300A** from changing the grayscale levels in this manner when a decrease in resolution is easily sensible, a substantial decrease in resolution can be avoided.

[0153] In the example described above, the grayscale level **b1** indicated by the input signal is equal to the grayscale level **b2**. However, the present invention is in no way limited to that specific preferred embodiment. Alternatively, the grayscale level **b1** indicated by the input signal may be different from the grayscale level **b2**. Nevertheless, if the grayscale level **b1** is different from the grayscale level **b2**, then the luminance level **Y_{b1}** that has been subjected to the grayscale-luminance conversion by the grayscale-to-luminance converting section **360a** shown in FIG. 8 is different from the luminance level **Y_{b2}** that has been subjected to the grayscale-luminance conversion by the grayscale-to-luminance converting section **360b**. If there is a great difference in luminance level between adjacent pixels (particularly when a text is displayed), the difference between those luminance levels **Y_{b1}** and **Y_{b2}** is even more significant.

[0154] Specifically, if the grayscale level **b1** is higher than the grayscale level **b2**, the luminance-to-grayscale converting sections **380a** and **380b** perform luminance-to-grayscale conversion based on the sum of the luminance level **Y_{b1}** and the magnitude of shift $\Delta s\alpha$ and the difference between the luminance level **Y_{b2}** and the magnitude of shift $\Delta s\beta$, respectively. In that case, as shown in FIG. 16, the luminance level **Y_{b1}'** corresponding to the grayscale level **b1'** will be higher by the magnitude of shift $\Delta s\alpha$ than the luminance level **Y_{b1}** corresponding to the grayscale level **b1**. The luminance level **Y_{b2}'** corresponding to the grayscale level **b2'** will be lower by the magnitude of shift $\Delta s\beta$ than the luminance level **Y_{b2}** corresponding to the grayscale level **b2**. As a result, the difference between the respective luminances corresponding to the grayscale levels **b1'** and **b2'** will be bigger than the difference between the respective luminances corresponding to the grayscale levels **b1** and **b2**.

[0155] Now take a look at four pixels, which are arranged in upper left, upper right, lower left and lower right portions of a matrix and will be referred to herein as pixels **P1** through **P4**, respectively. Also, the grayscale levels of respective blue subpixels as indicated by the input signal with respect to those pixels **P1** through **P4** will be identified herein by **b1** through **b4**, respectively. As already described with reference to FIG. 7, if the input signal indicates that the respective

subpixels should represent the same color (i.e., the grayscale levels **b1** through **b4** are equal to each other), the grayscale level **b1'** is higher than the grayscale level **b2'** and the grayscale level **b4'** is higher than the grayscale level **b3'**.

[0156] Also, suppose the input signal indicates that the pixels **P1** and **P3** should have high grayscales, the pixels **P2** and **P4** should have low grayscales, there is a display boundary between the pixels **P1** and **P3** and between the pixels **P2** and **P4**, the grayscale levels **b1** and **b2** satisfy $b_1 > b_2$, and the grayscale levels **b3** and **b4** satisfy $b_3 > b_4$. In that case, the difference between the respective luminances corresponding to the grayscale levels **b1'** and **b2'** will be bigger than the difference between the respective luminances corresponding to the grayscale levels **b1** and **b2**. On the other hand, the difference between the respective luminances corresponding to the grayscale levels **b3'** and **b4'** will be smaller than the difference between the respective luminances corresponding to the grayscale levels **b3** and **b4**.

[0157] Also, as described above, if the color indicated by the input signal is a single color (such as the color blue), then the hue coefficient **Hb** is either equal to, or close to, zero. In that case, the magnitude of shift decreases, the input signal is output as it is, and therefore, the resolution can be maintained. On the other hand, if the color indicated by the input signal is an achromatic color, then the hue coefficient **Hb** is either equal to, or close to, one. In that case, the luminance difference in a corrected image will increase and decrease from one column of pixels to another compared to the original image, thus making the edges look uneven and causing a decrease in resolution. Furthermore, if the grayscale levels **b1** and **b2** are either equal to, or close to, each other, such unevenness is not so noticeable considering the human visual sense. However, the bigger the difference between the grayscale levels **b1** and **b2**, the more noticeable such unevenness gets.

[0158] Hereinafter, a specific example will be described with reference to FIG. 17. In this example, the input signal is supposed to indicate that a line in an achromatic color with a relatively high luminance (i.e., a light gray line) should be displayed with a line width of one pixel on the background in an achromatic color with a relatively low luminance (i.e., a dark gray background). In that case, ideally, the viewer should sense that light gray line.

[0159] FIG. 17(a) shows the luminances of blue subpixels in the liquid crystal display device of Comparative Example 1. Only blue subpixels are shown in FIG. 17(a). Also, as for the grayscale levels **b1** through **b4** of the blue subpixels as indicated by the input signal with respect to the four pixels **P1** through **P4**, the grayscale levels **b1** and **b2** satisfy $b_1 > b_2$ and the grayscale levels **b3** and **b4** satisfy $b_3 > b_4$. In that case, in the liquid crystal display device of Comparative Example 1, the blue subpixels of those four pixels **P1** through **P4** have luminances corresponding to the grayscale levels **b1** through **b4** indicated by the input signal.

[0160] FIG. 17(b) shows the luminances of blue subpixels in the liquid crystal display device 100A. In this liquid crystal display device 100A, the grayscale level **b1'** of the blue subpixel of the pixel **P1** is higher than the grayscale level **b1**, the grayscale level **b2'** of the blue subpixel of the pixel **P2** is lower than the grayscale level **b2**, the grayscale level **b3'** of the blue subpixel of the pixel **P3** is lower than the grayscale level **b3**, and the grayscale level **b4'** of the blue subpixel of the pixel **P4** is higher than the grayscale level **b4**. In this manner, in any two pixels that are adjacent to each other in either the row direction or the column direction, the grayscale level (luminance) alternately increases and decreases with respect to the one indicated by the input signal. That is why comparing FIGS. 17(a) and 17(b) to each other, it can be seen that in this liquid crystal display device 100A, the difference between the grayscale levels **b1'** and **b2'** becomes greater than the difference between the grayscale levels **b1** and **b2** as indicated by the input signal. On the other hand, the difference between the grayscale levels **b3'** and **b4'** becomes smaller than the difference between the grayscale levels **b3** and **b4** as indicated by the input signal. As a result, in this liquid crystal display device 100A, not only the column including the pixels **P1** and **P3** that are associated with the relatively high grayscale levels **b1** and **b3** in the input signal but also the pixel **P4** that is associated with the relatively low grayscale level **b4** in the input signal have blue subpixels with relatively high luminances. In that case, even if the input signal indicates that a light gray line should be represented in the image displayed, this liquid crystal display device 100A will display not only the light gray line but also blue dotted lines adjacent to that line as shown in FIG. 17(c). Consequently, the display quality decreases significantly in the contours of the gray line.

[0161] In the example described above, the magnitude of shift Δs_α is obtained as the product of the luminance level difference $\Delta Y_b \alpha$ and the hue coefficient **Hb** and the magnitude of shift Δs_β is obtained as the product of the luminance level difference $\Delta Y_b \beta$ and the hue coefficient **Hb**. To avoid that, however, a different parameter may be used in determining the magnitudes of shift Δs_α and Δs_β . In general, when a text image is displayed, for example, the grayscale levels **b1** and **b2** are significantly different from each other in edges between a line of pixels that are displayed in the column direction and their adjacent pixels that are displayed in the background. That is why if the hue coefficient **Hb** is close to one, the difference between the grayscale levels **b1'** and **b2'** may further increase and the image quality may decrease as a result of the correction. To avoid such a situation, a continuous coefficient representing the degree of color continuity between adjacent pixels as indicated by the input signal may also be used as an additional parameter to calculate the magnitudes of shift Δs_α and Δs_β . If there is a relatively big difference between the grayscale levels **b1** and **b2**, the magnitudes of shift Δs_α and Δs_β may vary according to the continuous coefficient so as to be decreased either to zero or significantly. As a result, the decrease in image quality can be minimized. For example, if there is a relatively small difference between the grayscale levels **b1** and **b2**, then the continuous coefficient increases and the luminances of

blue subpixels belonging to adjacent pixels are controlled. However, if there is a relatively big difference between the grayscale levels **b1** and **b2** in the image boundary area, then the continuous coefficient may decrease and the luminances of the blue subpixels need not be controlled.

[0162] Hereinafter, a blue correcting section **300b'** for controlling the luminances of blue subpixels as described above will be described with reference to FIG. 18. In the following example, edge coefficients are used in place of the continuous coefficients. This blue correcting section **300b'** has the same configuration as the blue correcting section **300b** that has already been described with reference to FIG. 8 except that this blue correcting section **300b'** further includes an edge determining section **390** and a coefficient calculating section **395**. And description of their common features will be omitted herein to avoid redundancies. Although not shown in FIG. 18, the red correcting section **300r'** and the green correcting section **300g'** also have the same configuration as this blue correcting section **300b'**.

[0163] The edge determining section **390** obtains an edge coefficient **HE** based on the grayscale levels **b1** and **b2** that are indicated by the input signal. The edge coefficient **HE** is a function that increases as the difference in grayscale level between the blue subpixels of two adjacent pixels increases. If there is a relatively big difference between the grayscale levels **b1** and **b2** (i.e., if there is a low degree of continuity between the grayscale levels **b1** and **b2**), then the edge coefficient **HE** is high. On the other hand, if there is a relatively small difference between the grayscale levels **b1** and **b2** (i.e., if there is a high degree of continuity between the grayscale levels **b1** and **b2**), then the edge coefficient **HE** is low. In this manner, the lower the continuity in grayscale level between the blue subpixels of two adjacent pixels (i.e., the smaller the continuous coefficient described above), the higher the edge coefficient **HE**. And the higher the continuity in grayscale level between them (i.e., the greater the continuous coefficient described above), the lower the edge coefficient **HE**.

[0164] Also, the edge coefficient **HE** changes continuously according to the difference in grayscale level between the blue subpixels of two adjacent pixels. For example, if the absolute value of the difference in grayscale level between the blue subpixels of two adjacent pixels is $|b1-b2|$ and if $MAX = MAX(b1, b2)$, then the edge coefficient **HE** can be represented as $HE = |b1-b2| / MAX$. However, if $MAX=0$, then $HE = 0$.

[0165] Next, the coefficient calculating section **395** calculates a correction coefficient **HC** based on the hue coefficient **Hb** that has been obtained by the hue determining section **340** and the edge coefficient **HE** that has been obtained by the edge determining section **390**. The correction coefficient **HC** may be represented as $HC = Hb - HE$, for example. Optionally, clipping may be carried out so that the correction coefficient **HC** falls within the range of 0 to 1 in the coefficient calculating section **395**. Subsequently, the multiplying section **350** multiplies the correction coefficient **HC** and the luminance level differences $\Delta Y_B\alpha$ and $\Delta Y_B\beta$ together, thereby obtaining the magnitudes of shift $\Delta s\alpha$ and $\Delta s\beta$.

[0166] In this manner, the blue correcting section **300b'** obtains the magnitudes of shift $\Delta s\alpha$ and $\Delta s\beta$ by multiplying together the correction coefficient **HC**, which has been obtained based on the hue coefficient **Hb** and the edge coefficient **HE**, and the luminance level differences $\Delta Y_B\alpha$ and $\Delta Y_B\beta$. As described above, the edge coefficient **HE** is a function that increases as the difference in grayscale level between the blue subpixels of two adjacent pixels increases. That is why the greater the edge coefficient **HE**, the smaller the correction coefficient **HC** that regulates the distribution of luminances and the less uneven the edges can get. As also described above, the hue coefficient **Hb** is a function that changes continuously and the edge coefficient **HE** is also a function that changes continuously according to the difference in grayscale level between the blue subpixels of two adjacent pixels. For that reason, the correction coefficient **HC** also changes continuously and a sudden change on the display can be minimized.

[0167] In the example described above, the hue and the level difference are supposed to be determined based on the average grayscale level. However, this is only an example of the present invention. Alternatively, the hue and the level difference may also be determined based on the average luminance level. Nevertheless, since the luminance level is obtained by raising the grayscale level to the 2.2th power, the precision required also needs to be increased to the same degree. For that reason, the lookup table that stores the luminance level difference needs a huge circuit size, while the lookup table that stores the grayscale level difference can be implemented in a small circuit size.

[0168] As described above, the red, green and blue correcting sections **300r**, **300g** and **300b** appropriately control their associated hue coefficients **Hr**, **Hg** and **Hb**, thereby minimizing the color shift.

[0169] As can be seen from FIG. 7, if the red, green and blue correcting sections **300r**, **300g** and **300b** correct the grayscale levels, then two subpixels belonging to two pixels will have mutually different luminances. And if those subpixels have different luminances, then a decrease in resolution may be sensed. Particularly, the greater the difference in luminance (i.e., the greater the hue coefficients **Hr**, **Hg** and **Hb**), the more easily the decrease in resolution is sensible.

[0170] In that case, it is preferred that the hue coefficients **Hr** and **Hg** be smaller than the hue coefficient **Hb**. If the hue coefficient **Hb** is relatively large, then there will be a relatively big difference in luminance level between the blue subpixels. However, it is known that to the human eye, the resolution of the color blue is lower than that of any other color. Particularly when the red and green subpixels of the same pixel as the blue subpixel are turned ON, even if there is a relatively big difference in luminance between the blue subpixels, the decrease in the substantial resolution of the color blue is hardly sensible. In view of this consideration, it is more effective to correct the grayscale level of the blue subpixels than doing the same for subpixels of any other color. Also, as for colors other than the color blue, it is also

known that the color red also has a relatively low resolution. That is why even if the subpixel, of which the nominal resolution will decrease in an achromatic color with a middle grayscale, is a red subpixel, a decrease in substantial resolution is no more easily sensible to the eye than the blue subpixel is. Consequently, the same effect can be achieved even for the color red, too.

5 [0171] Furthermore, in the example described above, the correcting section **300A** is supposed to include the red, green and blue correcting sections **300r**, **300g** and **300b**. However, the present invention is in no way limited to that specific preferred embodiment.

10 [0172] That is to say, the correcting section **300A** may have only the red correcting section **300r** with no green correcting section or blue correcting section as shown in FIG. **19(a)**. Alternatively, the correcting section **300A** may have only the green correcting section **300g** with no red correcting section or blue correcting section as shown in FIG. **19(b)**. Still alternatively, the correcting section **300A** may have only the blue correcting section **300b** with no red correcting section or green correcting section as shown in FIG. **19(c)**. Or the correcting section **300A** may have any two of the red, green and blue correcting sections **300r**, **300g** and **300b**.

15 [0173] Also, as described above, the LCD panel **200A** operates in the VA mode. Hereinafter, a specific exemplary configuration for the LCD panel **200A** will be described. The LCD panel **200A** may operate in the MVA mode. A configuration for such an MVA mode LCD panel **200A** will be described with reference to FIG. **20(a)** to **20(c)**.

[0174] The LCD panel **200A** includes pixel electrodes **224**, a counter electrode **244** that faces the pixel electrodes **224**, and a vertical alignment liquid crystal layer **260** that is interposed between the pixel electrodes **224** and the counter electrode **244**. No alignment layers are shown in FIG. **20**.

20 [0175] Slits **227** or ribs **228** are arranged on the pixel electrodes **224** in contact with the liquid crystal layer **260**. On the other hand, slits **247** or ribs **248** are arranged on the counter electrode **244** in contact with the liquid crystal layer **260**. The former group of slits **227** or ribs **228** on the pixel electrodes **224** will be referred to herein as "first alignment control means", while the latter group of slits **247** or ribs **248** on the counter electrode **244** as "second alignment control means".

25 [0176] In each liquid crystal region defined between the first and second alignment control means, liquid crystal molecules **262** are given alignment control force by the first and second alignment control means and will fall (or tilt) in the direction indicated by the arrows in FIG. **20** when a voltage is applied to between the pixel electrodes **224** and the counter electrode **244**. That is to say, since the liquid crystal molecules **262** fall in the same direction in each liquid crystal region, such a region can be regarded as a liquid crystal domain.

30 [0177] The first and second alignment control means (which will sometimes be collectively referred to herein as "alignment control means") are arranged in stripes in each subpixel. FIGS. **20(a)** to **20(c)** are cross-sectional views as viewed on a plane that intersects at right angles with the direction in which those striped alignment control means runs. On two sides of each alignment control means, produced are two liquid crystal domains, in one of which liquid crystal molecules **262** fall in a particular direction and in the other of which liquid crystal molecules **262** fall in another direction that defines an angle of 180 degrees with respect to that particular direction. As the alignment control means, any of various alignment control means (domain regulating means) as disclosed in Japanese Patent Application Laid-Open Publication No. 11-242225 may be used, for example.

35 [0178] In FIG. **20(a)**, slits **227** (where there is no conductive film) are provided as the first alignment control means, and ribs (i.e., projections) **248** are provided as the second alignment control means. These slits **227** and ribs **248** are extended so as to run in stripes (or strips). When a potential difference is produced between one pixel electrode **224** and the counter electrode **244**, each slit **227** generates an oblique electric field in a region of the liquid crystal layer **260** around the edges of the slit **227** and induces alignments of the liquid crystal molecules **262** perpendicularly to the direction in which the slit **227** runs. On the other hand, each rib **248** induces alignments of the liquid crystal molecules **262** substantially perpendicularly to its side surface **248a**, and eventually, perpendicularly to the direction in which the rib **248** runs. Each slit **227** and its associated rib **248** are arranged parallel to each other with a certain interval left between them. That is to say, a liquid crystal domain is defined between one slit **227** and its associated rib **248** that are adjacent to each other.

40 [0179] Unlike the configuration shown in FIG. **20(a)**, one group of ribs **228** and another group of ribs **248** are provided as the first and second alignment control means, respectively, in the configuration shown in FIG. **20(b)**. Those two groups of ribs **228** and **248** are arranged parallel to each other with a certain gap left between them and induce alignments of the liquid crystal molecules **262** substantially perpendicularly to their side surfaces **228a** and **248a**, thereby producing liquid crystal domains between them.

45 [0180] Unlike the configuration shown in FIG. **20(a)**, one group of slits **227** and another group of slits **247** are provided as the first and second alignment control means, respectively, in the configuration shown in FIG. **20(c)**. When a potential difference is produced between the pixel electrodes **224** and the counter electrode **244**, those two groups of slits **227** and **247** generate an oblique electric field in a region of the liquid crystal layer **260** around their edges and induce alignments of the liquid crystal molecules **262** perpendicularly to the direction in which the slits **227** and **247** run. Those slits **227** and **247** are also arranged parallel to each other with a certain gap left between them, thereby producing liquid

crystal domains between them.

[0181] As described above, such ribs and slits may be used in any arbitrary combination as the first and second alignment control means. If the configuration shown in FIG. 20(a) is adopted for the LCD panel 200A, then the increase in the number of manufacturing processing steps required can be minimized. Specifically, even if slits need to be cut through the pixel electrodes, no additional process steps have to be done. As for the counter electrode, on the other hand, the number of manufacturing processing steps increases less with the ribs provided than with the slits cut. However, it is naturally possible to adopt a configuration in which only ribs are used as the alignment control means or a configuration in which just slits are used as the alignment control means.

[0182] FIG. 21 is a partial cross-sectional view schematically illustrating a cross-sectional structure for the LCD panel 200A. FIG. 22 is a plan view schematically illustrating a region allocated to one subpixel in the LCD panel 200A. The slits 227 have been cut so as to run in stripes and parallel to their adjacent ribs 248.

[0183] On the surface of an insulating substrate 222, arranged in contact with a liquid crystal layer 260 are gate bus lines (scan lines), source bus lines (signal lines) and TFTs (none of which are shown in FIG. 21), and an interlayer insulating film 225 is provided to cover all of those lines and TFTs. And pixel electrodes 224 have been formed on that interlayer insulating film 225. The pixel electrodes 224 and the counter electrode 244 face each other with the liquid crystal layer 260 interposed between them.

[0184] Striped slits 227 have been cut through the pixel electrodes 224. And almost the entire surface of the pixel electrodes 224, as well as inside the slits 227, is covered with a vertical alignment layer (not shown). As shown in FIG. 22, those slits 227 run in stripes. Two adjacent slits 227 are arranged parallel to each other so that each slit 227 splits the gap between its adjacent ribs 248 into two substantially evenly.

[0185] In the region between a striped slit 227 and its associated rib 248, which are arranged parallel to each other, the alignment direction of liquid crystal molecules 262 is controlled by the slit 227 and the rib 248 that interpose that region. As a result, two domains are produced on both sides of the slit 227 and on both sides of the rib 248 so that the alignment direction of the liquid crystal molecules 262 in one of those two domains is different from that of the liquid crystal molecules 262 in the other domain by 180 degrees. In this LCD panel 200A, the slits 227 are arranged to run in two different directions that define an angle of 90 degrees between them, so are the ribs 248 as shown in FIG. 22. Consequently, four liquid crystal domains, in any of which the alignment direction of the liquid crystal molecules 262 is different by 90 degrees from their counterparts in each of its adjacent domains, are produced in each subpixel.

[0186] Also, two polarizers (not shown) to put on the outside of the insulating substrates 222 and 242 are arranged as crossed Nicols so that their transmission axes cross each other substantially at right angles. If the polarizers are arranged so that the alignment direction in each of the four domains, which is different by 90 degrees from the one in any adjacent domain, and the transmission axis of its associated one of the polarizers define an angle of 45 degrees between them, the variation in retardation due to the creation of those domains can be used most efficiently. For that reason, the polarizers are preferably arranged so that their transmission axes define an angle of substantially 45 degrees with respect to the directions in which the slits 227 and the ribs 248 run. Also, in a display device such as a TV to which the viewer often changes his or her viewing direction horizontally, the transmission axis of one of the two polarizers is preferably arranged horizontally with respect to the display screen in order to reduce the viewing angle dependence of the display quality. In the LCD panel 200A with such a configuration, when a predetermined voltage is applied to the liquid crystal layer 260, a number of regions (i.e., domains) where the liquid crystal molecules 262 tilt in mutually different directions are produced in each subpixel, thus realizing a display with a wide viewing angle.

[0187] In the preferred embodiment described above, the LCD panel 200A is supposed to operate in the MVA mode. However, this is just an example of the present invention. Alternatively, the LCD panel 200A may also operate in a CPA mode.

[0188] Hereinafter, a CPA mode LCD panel 200A will be described with reference to FIGS. 23 and 24. Each subpixel electrode 224r, 224g, 224b of the LCD panel 200A shown in FIG. 23(a) has multiple notches 224 β at predetermined locations, which divide the subpixel electrode 224r, 224g, 224b into a number of unit electrodes 224 α . Each of those unit electrodes 224 α has a substantially rectangular shape. In the example shown in FIG. 23, each subpixel electrode 224r, 224g, 224b is supposed to be divided into three unit electrodes 224 α . However, the number of divisions does not have to be three.

[0189] When a voltage is applied to between the subpixel electrode 224r, 224g, 224b with such a configuration and the counter electrode (not shown), an oblique electric field is generated around the outer periphery of the subpixel electrode 224r, 224g, 224b and inside its notches 224 β , thereby producing a number of liquid crystal domains in which liquid crystal molecules are aligned axisymmetrically (i.e., have radially tilted orientations) as shown in FIG. 23(b). One liquid crystal domain is produced on each unit electrode 224 α . And in each liquid crystal domain, the liquid crystal molecules 262 tilt in almost every direction. That is to say, in this LCD panel 200A, there are an infinite number of regions where the liquid crystal molecules 262 tilt in mutually different directions. As a result, a wide viewing angle display is realized.

[0190] The subpixel electrode 224r, 224g, 224b shown in FIG. 23 has notches 224 β . Alternatively, the notches 224 β

may be replaced with openings 224γ as shown in FIG. 24. Each subpixel electrode $224r$, $224g$, $224b$ shown in FIG. 24 has multiple openings 224γ , which divide the subpixel electrode $224r$, $224g$, $224b$ into a number of unit electrodes 224α . When a voltage is applied to between such a subpixel electrode $224r$, $224g$, $224b$ and the counter electrode (not shown), an oblique electric field is generated around the outer periphery of the subpixel electrode $224r$, $224g$, $224b$ and inside its openings 224γ , thereby producing a number of liquid crystal domains in which liquid crystal molecules are aligned axisymmetrically (i.e., have radially tilted orientations).

[0191] In the examples illustrated in FIGS. 23 and 24, each single subpixel electrode $224r$, $224g$, $224b$ has either multiple notches 224β or multiple openings 224γ . However, if each subpixel electrode $224r$, $224g$, $224b$ needs to be split into two, only one notch 224β or opening 224γ may be provided. In other words, by providing at least one notch 224β or opening 224γ for each subpixel electrode $224r$, $224g$, $224b$, multiple axisymmetrically aligned liquid crystal domains can be produced. The subpixel electrode $224r$, $224g$, $224b$ may have any of various shapes as disclosed in Japanese Patent Application Laid-Open Publication No. 2003-43525, for example.

[0192] FIG. 25 shows the xy chromaticity diagram of the XYZ color system. The spectrum locus and dominant wavelengths are shown in FIG. 25. In the LCD panel **200A**, red subpixels have a dominant wavelength of 605 nm to 635 nm, green subpixels have a dominant wavelength of 520 nm to 550 nm, and blue subpixels have a dominant wavelength of 470 nm or less.

[0193] In the preferred embodiment described above, the luminances of blue subpixels are supposed to be controlled by using, as a unit, two blue subpixels belonging to two pixels that are arranged adjacent to each other in the row direction. However, the present invention is in no way limited to that specific preferred embodiment. Alternatively, the luminances of blue subpixels may also be controlled by using, as a unit, two blue subpixels belonging to two pixels that are arranged adjacent to each other in the column direction. Nevertheless, if those blue subpixels belonging to two adjacent pixels in the column direction are used as a unit, line memories and other circuit components are needed, thus increasing the circuit size required.

[0194] FIG. 26 is a schematic representation illustrating a blue correcting section **300b'** that is designed to control the luminances using, as a unit, two blue subpixels belonging to two pixels that are adjacent to each other in the column direction. As shown in FIG. 26(a), the blue correcting section **300b'** includes first-stage line memories **300s**, a grayscale control section **300t**, and second-stage line memories **300u**. The grayscale levels **r1**, **g1** and **b1** are indicated by the input signal for red, green and blue subpixels belonging to one pixel. On the other hand, the grayscale levels **r2**, **g2** and **b2** are indicated by the input signal for red, green and blue subpixels belonging to another pixel that is adjacent to the former pixel in the column direction and located on the next row. The first-stage line memories **300s** delay the input of the grayscale levels **r1**, **g1**, and **b1** to the grayscale control section **300t** by one line.

[0195] FIG. 26(b) is a schematic representation illustrating the grayscale control section **300t**. In the grayscale control section **300t**, the average grayscale level b_{ave} of the grayscale levels **b1** and **b2** is calculated by using an adding section **310b**. Next, a grayscale level difference section **320** calculates two grayscale level differences $\Delta b\alpha$ and $\Delta b\beta$ with respect to the single average grayscale level b_{ave} . Thereafter, a grayscale-to-luminance converting section **330** converts the grayscale level differences $\Delta b\alpha$ and $\Delta b\beta$ into luminance level differences $\Delta Y_{b\alpha}$ and $\Delta Y_{b\beta}$, respectively.

[0196] Meanwhile, the average grayscale level **rave** of the grayscale levels **r1** and **r2** is calculated by using an adding section **310r**. And the average grayscale level **gave** of the grayscale levels **g1** and **g2** is calculated by using an adding section **310g**. Then, a hue determining section **340** calculates a hue coefficient **Hb** based on these average grayscale levels **rave**, **gave** and **bave**.

[0197] Next, the magnitudes of shift $\Delta s\alpha$ and $\Delta s\beta$ are calculated. In this case, the magnitude of shift $\Delta s\alpha$ is obtained as the product of $\Delta Y_{b\alpha}$ and the hue coefficient **Hb**, while the magnitude of shift $\Delta s\beta$ is obtained as the product of $\Delta Y_{b\beta}$ and the hue coefficient **Hb**. A multiplying section **350** multiplies the luminance level differences $\Delta Y_{b\alpha}$ and $\Delta Y_{b\beta}$ by the hue coefficient **Hb**, thereby obtaining the magnitudes of shift $\Delta s\alpha$ and $\Delta s\beta$.

[0198] Meanwhile, a grayscale-to-luminance converting section **360a** carries out a grayscale-to-luminance conversion on the grayscale level **b1**, thereby obtaining a luminance level Y_{b1} . In the same way, another grayscale-to-luminance converting section **360b** carries out a grayscale-to-luminance conversion on the grayscale level **b2**, thereby obtaining a luminance level Y_{b2} . Next, an adding and subtracting section **370a** adds the luminance level Y_{b1} and the magnitude of shift $\Delta s\alpha$ together, and then the sum is subjected to luminance-to-grayscale conversion by a luminance-to-grayscale converting section **380a**, thereby obtaining a grayscale level **b1'**. On the other hand, another adding and subtracting section **370b** subtracts the magnitude of shift $\Delta s\beta$ from the luminance level Y_{b2} , and then the remainder is subjected to luminance-to-grayscale conversion by another luminance-to-grayscale converting section **380b**, thereby obtaining a grayscale level **b2'**. After that, the second-stage line memories **300u** delay the output of the grayscale levels **r2**, **g2** and **b2'** by one line as shown in FIG. 26(a). In this manner, the blue correcting section **300b'** controls the luminances by using, as a unit, two blue subpixels belonging to two pixels that are adjacent to each other in the column direction.

[0199] In the preferred embodiment described above, the input signal is supposed to be a YCrCb signal, which is usually used as a color TV signal. However, the input signal does not have to be a YCrCb signal but may also indicate the grayscale levels of respective subpixels representing either the three primary colors of R, G and B or any other set

of three primary colors such as Ye, M and C (where Ye denotes yellow, M denotes magenta and C denotes cyan).

[0200] Also, in the preferred embodiment described above, the grayscale levels are supposed to be indicated by the input signal and the correcting section **300A** is supposed to correct the grayscale level of blue subpixels. However, the present invention is in no way limited to that specific preferred embodiment. Alternatively, the luminance levels may be indicated by the input signal. Or the grayscale levels may be converted into luminance levels and then the correcting section **300A** may correct the luminance level of blue subpixels. Nevertheless, the luminance level is obtained by raising the grayscale level to the 2.2th power and the precision of the luminance level should be higher than that of the grayscale level to the same degree. That is why a circuit for correcting the grayscale levels can be implemented at a lower cost than a circuit for correcting the luminance levels.

[0201] Furthermore, in the preferred embodiment described above, when an achromatic color should be represented, the grayscale levels of red, green and blue subpixels yet to be entered into the LCD panel **200A** are supposed to be equal to each other. However, this is just an example of the present invention. Optionally, the liquid crystal display device may further include an independent gamma correction processing section for performing independent gamma correction processing. And even when an achromatic color needs to be represented, the grayscale levels of red, green and blue subpixels yet to be entered into the LCD panel **200A** may be slightly different from each other.

[0202] Hereinafter, a liquid crystal display device **100A'** that further includes an independent gamma correction processing section **280** will be described with reference to FIG. 27. Except the independent gamma correction processing section **280**, however, the liquid crystal display device **100A'** has the same configuration as the liquid crystal display device **100A** shown in FIG. 1.

[0203] In the liquid crystal display device **100A'** shown in FIG. 27(a), the grayscale levels **r'**, **g'** and **b'** that have been corrected by the correcting section **300A** are input to the independent gamma correction processing section **280**, which performs independent gamma correction processing on them. Without the independent gamma correction processing, if the color indicated by the input signal changes from black to white while remaining achromatic colors, then the chromaticity of the achromatic color may vary uniquely to the LCD panel **200A** when the LCD panel **200A** is viewed straight on. By performing the independent gamma correction processing, however, such a chromaticity variation can be minimized.

[0204] The independent gamma correction processing section **280** includes red, green and blue processing sections **282r**, **282g** and **282b** for performing independent gamma correction processing on the grayscale levels **r'**, **g'** and **b'**, respectively. As a result of the independent gamma correction processing that has been performed by these processing sections **282r**, **282g** and **282b**, the grayscale levels **r'**, **g'** and **b'** are converted into grayscale levels **r_g'**, **g_g'** and **b_g'**, respectively. In the same way, grayscale levels **r**, **g** and **b** are converted into grayscale levels **r_g**, **g_g** and **b_g**, respectively. After that, those grayscale levels **rg'**, **gg'** and **bg'** through **r_g**, **g_g** and **b_g** that have been subjected to the independent gamma correction processing by the independent gamma correction processing section **280** are input to the LCD panel **200A**.

[0205] In the liquid crystal display device **100A'** shown in FIG. 27(a), the independent gamma correction processing section **280** is positioned after the correcting section **300A**. However, the present invention is in no way limited to that specific preferred embodiment. Alternatively, the independent gamma correction processing section **280** may also be positioned before the correcting section **300A** as shown in FIG. 27(b). In that case, the independent gamma correction processing section **280** makes independent gamma correction processing on the grayscale levels **r**, **g** and **b** indicated by the input signal, thereby obtaining grayscale levels **r_g**, **g_g** and **b_g**. After that, the correcting section **300A** makes correction on the signal that has already been subjected to the independent gamma correction processing. As the multiplier for use to perform a luminance-to-grayscale conversion in the correcting section **300A**, not the fixed value (e.g., 2.2th power) but a value that has been selected according to the characteristic of the LCD panel **200A** is used. By providing the independent gamma correction processing section **280** in this manner, the variation in the chromaticity of an achromatic color according to the lightness can also be reduced.

(EMBODIMENT 2)

[0206] In the preferred embodiment described above, each subpixel is supposed to have a single luminance. However, the present invention is in no way limited to that specific preferred embodiment. Optionally, a multi-pixel structure may be adopted and each subpixel may have multiple regions with mutually different luminances.

[0207] Hereinafter, a second specific preferred embodiment of a liquid crystal display device according to the present invention will be described with reference to FIG. 28. The liquid crystal display device **100B** of this preferred embodiment includes an LCD panel **200B** and a correcting section **300B**, which also includes red, green and blue correcting sections **300r**, **300g** and **300b**. This liquid crystal display device **100B** has the same configuration as its counterpart of the first preferred embodiment described above except that each subpixel in the LCD panel **200B** has multiple regions that may have mutually different luminances and that the effective potential of a divided electrode that defines such regions with different luminances varies with the potential on a CS bus line. Thus, description of their common features will be omitted

herein to avoid redundancies.

[0208] FIG. 29(a) illustrates how pixels and subpixels, included in each of those pixels, may be arranged in this LCD panel 200B. As an example, FIG. 29(a) illustrates an arrangement of pixels in three columns and three rows. Each of those pixels includes three subpixels, which are red, green and blue subpixels **R**, **G** and **B**. The luminances of these subpixels can be controlled independently of each other.

[0209] In this liquid crystal display device 100B, each of the three subpixels **R**, **G** and **B** has two divided regions. Specifically, the red subpixel **R** has first and second regions **Ra** and **Rb**, the green subpixel **G** has first and second regions **Ga** and **Gb**, and the blue subpixel **B** has first and second regions **Ba** and **Bb**.

[0210] In each of these subpixels **R**, **G** and **B**, the luminance values of its multiple regions may be controlled to be different from each other. As a result, the viewing angle dependence of the gamma characteristic, which refers to a phenomenon that the gamma characteristic when the display screen is viewed straight on is different from the one when the display screen is viewed obliquely, can be reduced. Methods for reducing the viewing angle dependence of the gamma characteristic are disclosed in Japanese Patent Application Laid-Open Publications Nos. 2004-62146 and 2004-78157, for example. By controlling the luminances of multiple different regions of each of those subpixels **R**, **G** and **B** so that those luminances are different from each other, the viewing angle dependence of the gamma characteristic can be reduced as well as is disclosed in Japanese Patent Application Laid-Open Publications Nos. 2004-62146 and 2004-78157. Such a red, green and blue (**R**, **G** and **B**) structure is also called a "divided structure". In the following description, one of the first and second regions that has the higher luminance will sometimes be referred to herein as a "bright region" and the other region with the lower luminance as a "dark region".

[0211] FIG. 29(b) illustrates a configuration for a blue subpixel **B** in the liquid crystal display device 100B. Although not shown in FIG. 29(b), red and green subpixels **R** and **G** also have the same configuration.

[0212] The blue subpixel **B** has two regions **Ba** and **Bb** that are defined by divided electrodes 224x and 224y, respectively. A TFT 230x and a storage capacitor 232x are connected to the divided electrode 224x and a TFT 230y and a storage capacitor 232y are connected to the divided electrode 224y. The TFTs 230x and 230y have their respective gate electrodes connected to the same gate bus line Gate and have their respective source electrodes connected in common to the same source bus line S. The storage capacitors 232x and 232y are connected to CS bus lines CS1 and CS2, respectively. The storage capacitor 232x is formed by a storage capacitor electrode that is electrically connected to the divided electrode 224x, a storage capacitor counter electrode that is electrically connected to the CS bus line CS1, and an insulating layer (not shown) that is arranged between those two electrodes. Likewise, the storage capacitor 232y is formed by a storage capacitor electrode that is electrically connected to the divided electrode 224y, a storage capacitor counter electrode that is electrically connected to the CS bus line CS2, and an insulating layer (not shown) that is arranged between those two electrodes. The storage capacitor counter electrodes of the storage capacitors 232x and 232y are independent of each other and can be supplied with mutually different storage capacitor counter voltages through the CS bus lines CS1 and CS2, respectively. Thus, after a voltage has been applied to the divided electrodes 224x and 224y through the source bus line S while the TFTs 230x and 230y are in ON state, the TFTs 230x and 230y may turn OFF and the potentials on the CS bus lines CS1 and CS2 may vary into different values. In that case, the divided electrode 224x will have a different effective voltage from the divided electrode 224y. As a result, the first region **Ba** comes to have a different luminance from the second region **Bb**.

[0213] FIGS. 30(a) and 30(b) illustrate how the LCD panel 200B may look in this liquid crystal display device 100B. In FIG. 30(a), the input signal indicates that every pixel should represent the same achromatic color. On the other hand, in FIG. 30(b), the input signal indicates that every pixel should represent the same chromatic color. In FIGS. 30(a) and 30(b), two pixels that are adjacent to each other in the row direction are taken as an example. One of those two pixels is identified by P1 and its red, green and blue subpixels are identified by R1, G1 and B1, respectively. The other pixel is identified by P2 and its red, green and blue subpixels are identified by R2, G2 and B2, respectively.

[0214] First of all, it will be described with reference to FIG. 30(a) how the LCD panel 200B looks when the color indicated by the input signal is an achromatic color. In such a situation, the grayscale levels of the red, green and blue subpixels are equal to each other.

[0215] In this case, the red, green and blue correcting sections 300r, 300g and 300b shown in FIG. 28 make corrections so that the luminances of the red, green and blue subpixels **R1**, **G1** and **B1** of one **P1** of the two adjacent pixels are different from those of the red, green and blue subpixels **R2**, **G2** and **B2** of the other pixel **P2**.

[0216] Using two subpixels belonging to two adjacent pixels as a unit, each of the red, green and blue correcting sections 300r, 300g and 300b controls the luminances of those subpixels. That is why even if the input signal indicates that such subpixels belonging to two adjacent pixels have the same grayscale level, the LCD panel 200B corrects the grayscale level so that those two subpixels have mutually different luminances. In this preferred embodiment, each of the red, green and blue correcting sections 300r, 300g and 300b makes correction on the grayscale levels of its associated subpixels belonging to two pixels that are adjacent to each other in the row direction. As a result of the correction that has been made by each of the red, green and blue correcting sections 300r, 300g and 300b, one of the two subpixels belonging to those two adjacent pixels has its luminance increased by the magnitude of shift $\Delta\alpha$, while the other subpixel

has its luminance decreased by the magnitude of shift $\Delta s\beta$. Consequently, those two subpixels belonging to the two adjacent pixels have mutually different luminances. In this case, the luminance of the bright subpixel is higher than a luminance corresponding to a reference grayscale level, while that of the dark subpixel is lower than the luminance corresponding to the reference grayscale level. Also, when the screen is viewed straight on, the difference between the luminance of the bright subpixel and the luminance corresponding to the reference grayscale level is substantially equal to the difference between the luminance corresponding to the reference grayscale level and the luminance of the dark subpixel. That is why the average of the luminances of respective subpixels belonging to two adjacent pixels in this LCD panel **200B** is substantially equal to that of the luminances corresponding to the grayscale levels of two adjacent subpixels as indicated by the input signal. In this manner, the red, green and blue correcting sections **300r**, **300g** and **300b** make corrections, thereby improving the viewing angle characteristic when the screen is viewed obliquely. In FIG. **30(a)**, two subpixels (e.g., red subpixels) belonging to two pixels that are adjacent to each other in the row direction have opposite brightness levels and two subpixels (e.g., red subpixels) belonging to two pixels that are adjacent to each other in the column direction also have opposite brightness levels.

[0217] For example, if the input signal indicates that the grayscale levels of the red, green and blue subpixels should be (100, 100, 100), the liquid crystal display device **100B** corrects the grayscale levels of those red, green and blue subpixels into either 137 ($= (2 \times (100/255)^{2.2})^{1/2.2} \times 255$) or zero. As a result, in the LCD panel **200B**, the red, green and blue subpixels **R1**, **G1** and **B1** belonging to the pixel **P1** come to have luminances corresponding to the grayscale levels (137, 0, 137), while the red, green and blue subpixels **R2**, **G2** and **B2** belonging to the pixel **P2** come to have luminances corresponding to the grayscale levels (0, 137, 0).

[0218] In this LCD panel **200B**, the red and blue subpixels **R1** and **B1** of the pixel **P1** and the green subpixel **G2** of the pixel **P2** have an overall luminance corresponding to the grayscale level 137, the regions **Ra**, **Ga** and **Ba** of the red, green and blue subpixels **R1**, **G2** and **B1** have a luminance corresponding to the grayscale level 188 ($= (2 \times (137/255)^{2.2})^{1/2.2} \times 255$), and the regions **Rb**, **Gb** and **Bb** of the red, green and blue subpixels **R1**, **G2** and **B1** have a luminance corresponding to the grayscale level 0. On the other hand, the red, green and blue subpixels **R2**, **G1** and **B2** have an overall luminance corresponding to the grayscale level 0 and the regions **Ra** and **Rb** of the red subpixel **R2**, the regions **Ga** and **Gb** of the green subpixel **G1** and the regions **Ba** and **Bb** of the blue subpixel **B2** have a luminance corresponding to the grayscale level 0.

[0219] If a multi-pixel drive is performed, the distribution of the luminance levels Y_{b1} and Y_{b2} to the regions **Ba** and **Bb** of the blue subpixels **B1** and **B2** is determined by the structure and settings of the LCD panel **200B** although not described in detail herein. Specifically, when viewed straight on, the LCD panel **200B** may be designed so that the average luminance of the regions **Ba** and **Bb** of the blue subpixel **B1** agrees with the luminance corresponding to the grayscale level **b1'** or **b2'** of the blue subpixel.

[0220] Next, it will be described with reference to FIG. **30(b)** how the LCD panel **200B** looks when the input signal indicates that a chromatic color should be represented. In this case, the input signal is supposed to indicate that the blue subpixel should have a higher grayscale level than the red and green subpixels.

[0221] For example, if the input signal indicates that the grayscale levels of the red, green and blue subpixels should be (50, 50, 100), the liquid crystal display device **100B** corrects the grayscale levels of the red and green subpixels into either 69 ($= (2 \times (50/255)^{2.2})^{1/2.2} \times 255$) or zero. On the other hand, the liquid crystal display device **100B** corrects the grayscale level of the blue subpixel differently from the red and green subpixels. Specifically, the grayscale level of 100 of the blue subpixel indicated by the input signal is corrected into either 121 or 74. It should be noted that $2 \times (100/255)^{2.2} = (121/255)^{2.2} + (74/255)^{2.2}$. Consequently, the red, green and blue subpixels **R1**, **G1** and **B1** belonging to the pixel **P1** in this LCD panel **200B** come to have luminances corresponding to the grayscale levels (69, 0, 121) and the red, green and blue subpixels **R2**, **G2** and **B2** belonging to the pixel **P2** come to have luminances corresponding to the grayscale levels (0, 69, 74).

[0222] In this LCD panel **200B**, the red subpixel **R1** of the pixel **P1** has an overall luminance corresponding to the grayscale level 69, the region **Ra** of the red subpixel **R1** has a luminance corresponding to the grayscale level 95 ($= (2 \times (69/255)^{2.2})^{1/2.2} \times 255$), and the region **Rb** of the red subpixel **R1** has a luminance corresponding to the grayscale level 0. In the same way, the region **Ga** of the green subpixel **G2** has a luminance corresponding to the grayscale level 95 ($= (2 \times (69/255)^{2.2})^{1/2.2} \times 255$), and the region **Gb** of the green subpixel **G2** has a luminance corresponding to the grayscale level 0.

[0223] The blue subpixel **B1** of the pixel **P1** has an overall luminance corresponding to the grayscale level 121, the region **Ba** of the blue subpixel **B1** has a luminance corresponding to the grayscale level 167 ($= (2 \times (121/255)^{2.2})^{1/2.2} \times 255$), and the region **Bb** of the blue subpixel **B1** has a luminance corresponding to the grayscale level 0. In the same way, the blue subpixel **B2** has an overall luminance corresponding to the grayscale level 74, the region **Ba** of the blue subpixel **B2** has a luminance corresponding to the grayscale level 0, and the region **Bb** of the blue subpixel **B2** has a luminance corresponding to the grayscale level 102 ($= (2 \times (74/255)^{2.2})^{1/2.2} \times 255$).

(EMBODIMENT 3)

[0224] In the preferred embodiments of the present invention described above, the luminance is supposed to be controlled using two subpixels belonging to two adjacent pixels as a unit. However, the present invention is in no way limited to those specific preferred embodiments. Optionally, the luminance may also be controlled using multiple different regions of a single subpixel as a unit.

[0225] Hereinafter, a third specific preferred embodiment of a liquid crystal display device according to the present invention will be described with reference to FIG. 31. The liquid crystal display device **100C** of this preferred embodiment includes an LCD panel **200C** and a correcting section **300C**, which also includes red, green and blue correcting sections **300r**, **300g** and **300b**. This liquid crystal display device **100C** has the same configuration as its counterpart of the first preferred embodiment described above except that each subpixel has multiple regions, of which the luminances can be different from each other, in the LCD panel **200C** and two source bus lines are provided for each column of subpixels. And description of their common features will be omitted herein to avoid redundancies.

[0226] FIG. **32(a)** illustrates how pixels may be arranged in the LCD panel **200C** and how subpixels may be arranged in each of those pixels. In FIG. **32(a)**, illustrated as an example is a matrix of pixels that are arranged in three columns and three rows. Each of those pixels has three subpixels that are red, green and blue subpixels **R**, **G** and **B**.

[0227] In this liquid crystal display device **100C**, each of the three subpixels **R**, **G** and **B** has two divided regions. Specifically, the red subpixel **R** has first and second regions **Ra** and **Rb**, the green subpixel **G** has first and second regions **Ga** and **Gb**, and the blue subpixel **B** has first and second regions **Ba** and **Bb**. The luminances of these two different regions of each subpixel are controllable independently of each other.

[0228] FIG. **32(b)** illustrates a configuration for a blue subpixel **B** in the liquid crystal display device **100C**. Although not shown in FIG. **32(b)**, red and green subpixels **R** and **G** also have the same configuration.

[0229] The blue subpixel **B** has two regions **Ba** and **Bb** that are respectively defined by divided electrodes **224x** and **224y**, to which TFTs **230x** and **230y** are respectively connected. The TFTs **230x** and **230y** have their respective gate electrodes connected to the same gate bus line Gate and have their respective source electrodes connected to two different source bus lines **S1** and **S2**, respectively. Thus, while the TFTs **230x** and **230y** are in ON state, a voltage is applied to the divided electrodes **224x** and **224y** through the source bus lines **S1** and **S2**, respectively, and the first region **Ba** may have a different luminance from the second region **Bb**.

[0230] In this LCD panel **200C**, the voltage to be applied to the divided electrodes **224x** and **224y** can be set much more flexibly than in the LCD panel **200B** described above. Thus, in this LCD panel **200C**, the luminances can be controlled using multiple different regions of a single subpixel as a unit. In this LCD panel **200C**, however, two source bus lines are provided for each column of subpixels and the source driver (not shown) needs to perform two different series of signal processing on the single column of subpixels.

[0231] In this LCD panel **200C**, the luminances are controlled using multiple different regions of a single subpixel as a unit, and therefore, the resolution never decreases. When a middle grayscale is displayed, however, regions with low luminance may be sensed according to the pixel size and the color to be represented, and the display quality may be debased. To overcome such a problem, in this liquid crystal display device **100C**, the correcting section **300C** minimizes such a decline in display quality.

[0232] FIGS. **33(a)** and **33(b)** illustrate how the LCD panel **200C** may look in this liquid crystal display device **100C**. In FIG. **33(a)**, the input signal indicates that every pixel should represent the same achromatic color. On the other hand, in FIG. **33(b)**, the input signal indicates that every pixel should represent the same chromatic color. In FIGS. **33(a)** and **33(b)**, two regions in a single subpixel are taken as an example.

[0233] First of all, it will be described with reference to FIG. **33(a)** how the LCD panel **200C** looks when the color indicated by the input signal is an achromatic color. In such a situation, the grayscale levels of the red, green and blue subpixels are equal to each other.

[0234] In this case, the red, green and blue correcting sections **300r**, **300g** and **300b** shown in FIG. **31** make corrections so that in the LCD panel **200C**, the two regions **Ra** and **Rb**, **Ga** and **Gb**, and **Ba** and **Bb** have mutually different luminances in each of the red, green and blue subpixels **R1**, **G1** and **B1**.

[0235] Since the red and green correcting sections **300r** and **300g** operate in the same way as the blue correcting section **300b**, only the operation of the blue correcting section **300b** will be described. Specifically, the blue correcting section **300b** controls the luminance of the blue subpixel **B1** using its multiple different regions as a unit and corrects the grayscale levels so that those regions **Ba** and **Bb** of the blue subpixel **B1** have mutually different luminances on the LCD panel **200C**.

[0236] As a result of the correction that has been made by the blue correcting section **300b**, the region **Ba** of the blue subpixel **B1** has its luminance increased by the magnitude of shift $\Delta S\alpha$, while the other region **Bb** thereof has its luminance decreased by the magnitude of shift $\Delta S\beta$. Consequently, those two regions **Ba** and **Bb** of the blue subpixel **B1** have mutually different luminances. In this case, the luminance of the bright region is higher than a luminance corresponding to a reference grayscale level, while that of the dark region is lower than the luminance corresponding to the reference

grayscale level. Also, when the screen is viewed straight on, the first and second regions **Ba** and **Bb** have substantially the same area, the difference between the luminance of the bright region and the luminance corresponding to the reference grayscale level is substantially equal to the difference between the luminance corresponding to the reference grayscale level and the luminance of the dark region. That is why the average of the luminances of those two regions

Ba and **Bb** on this LCD panel 200C is substantially equal to the luminance corresponding to the grayscale level of the blue subpixel as indicated by the input signal. The blue correcting section **300b** makes correction in this manner, thereby improving the viewing angle characteristic when the screen is viewed obliquely.

[0237] Next, it will be described with reference to FIG. **33(b)** how the LCD panel 200C looks when the input signal indicates that a chromatic color should be represented. In this case, the input signal is supposed to indicate that the blue subpixel should have a higher grayscale level than the red and green subpixels.

[0238] For example, if the input signal indicates that the grayscale levels of the red, green and blue subpixels should be (50, 50, 100), the liquid crystal display device 100C corrects the grayscale levels of the red and green subpixels into either 69 ($= (2 \times (50/255)^{2.2})^{1/2.2} \times 255$) or zero. On the other hand, the liquid crystal display device 100C corrects the grayscale level of the blue subpixel differently from the red and green subpixels. Specifically, the grayscale level of 100 of the blue subpixel indicated by the input signal is corrected into either 121 or 74. It should be noted that $2 \times (100/255)^{2.2} = (121/255)^{2.2} + (74/255)^{2.2}$. Consequently, the regions **Ra**, **Ga** and **Ba** of the red, green and blue subpixels **R1**, **G1** and **B1** in this LCD panel **200C** come to have luminances corresponding to the grayscale levels (69, 0, 121), while the regions **Rb**, **Gb** and **Bb** of the red, green and blue subpixels **R1**, **G1** and **B1** come to have luminances corresponding to the grayscale levels (0, 69, 74).

[0239] FIG. **34** illustrates a specific configuration for the blue correcting section **300b**. In this blue correcting section **300b**, the luminance level **Y_b** obtained by the grayscale-to-luminance converting section **360** includes luminance levels **Y_{b1}** and **Y_{b2}**. That is why the luminance levels **Y_{b1}** and **Y_{b2}** are equal to each other before subjected to arithmetic operations in adding and subtracting sections **370a** and **370b**. In the correcting section **300C**, the grayscale level **b1'** is associated with the region **Ba** of the blue subpixel **B1** and the grayscale level **b2'** is associated with the region **Bb** of the blue subpixel **B1**.

[0240] In the LCD panel **200C** described above, the number of source bus lines to provide is supposed to be double the number of columns of subpixels. However, the present invention is in no way limited to that specific preferred embodiment. Alternatively, the number of source bus lines may be the same as that of columns of subpixels and the number of gate bus lines to provide may be double the number of rows of subpixels.

[0241] FIG. **35** is a schematic representation illustrating an alternative LCD panel **200C'**. In this LCD panel **200C'**, the blue subpixel **B** has two regions **Ba** and **Bb** that are respectively defined by divided electrodes **224x** and **224y**, to which TFTs **230x** and **230y** are respectively connected. The TFTs **230x** and **230y** have their respective gate electrodes connected to two different gate bus lines **Gate1** and **Gate2** and have their respective source electrodes connected to the same source bus line **S**. Thus, when the TFT **230x** is in ON state, a voltage is applied to the divided electrode **224x** through the source bus line **S**. On the other hand, when the TFT **230y** is in ON state, a voltage is applied to the divided electrode **224y** through the source bus line **S**, too. As a result, the first region **Ba** may have a different luminance from the second region **Bb**. In this manner, in this alternative LCD panel **200C'**, the luminances can also be controlled using two different regions of a single subpixel as a unit. However, in this LCD panel **200C'**, two gate bus lines need to be provided for each row of pixels and need to be driven at a high rate by a gate driver (not shown).

[0242] In the second and third preferred embodiments of the present invention described above, each subpixel **R**, **G** or **B** is supposed to be split into two regions. However, the present invention is in no way limited to those specific preferred embodiments. Optionally, each subpixel **R**, **G** or **B** may be divided into three or more regions.

(EMBODIMENT 4)

[0243] Hereinafter, a fourth preferred embodiment of a liquid crystal display device according to the present invention will be described. As shown in FIG. **36(a)**, the liquid crystal display device **100D** of this preferred embodiment includes an LCD panel **200D** and a correcting section **300D**, which includes a red correcting section **300r**, a green correcting section **300g** and a blue correcting section **300b** for controlling the luminances using, as a unit, two red, green or blue subpixels that are adjacent to each other in the row direction.

[0244] FIG. **36(b)** is an equivalent circuit diagram of a region of the LCD panel **200D**. In this LCD panel **200D**, subpixels are arranged in columns and rows so as to form a matrix pattern. Each of those subpixels has two regions, of which the luminances may be different from each other. Since the configuration of each subpixel is the same as what has already been described with reference to FIG. **29(b)**, the description thereof will be omitted herein to avoid redundancies.

[0245] Now look at the subpixel that is defined by a gate bus line **GBL_n** representing an n^{th} row and a source bus line **SBL_m** representing an m^{th} column. Region **A** of that subpixel includes a liquid crystal capacitor **CLCA_{n,m}** and a storage capacitor **CCSA_{n,m}**, while region **B** of that subpixel includes a liquid crystal capacitor **CLCB_{n,m}** and a storage capacitor **CCSB_{n,m}**. Each liquid crystal capacitor is formed by a divided electrode **224x** or **224y**, a counter

electrode **ComLC**, and a liquid crystal layer interposed between them. Each storage capacitor is formed by a storage capacitor electrode, an insulating film, and a storage capacitor counter electrode (**ComCSA_n** or **ComCSB_n**). The two divided electrodes **224x** and **224y** are connected to a common source bus line **SBL_m** by way of their associated TFTA_{n,m} and TFTB_{n,m}, respectively. The ON/OFF states of TFTA_{n,m} and TFTB_{n,m} are controlled with a scan signal voltage supplied to a common gate bus line **GBL_n**. When the two TFTs are ON, a display signal voltage is applied to the respective divided electrodes **224x** and **224y** and storage capacitor electrodes of the two regions **A** and **B** through a common source bus line. The storage capacitor counter electrode of one of the two regions **A** and **B** is connected to a storage capacitor trunk (CS trunk) **CSVtype1** by way of a CS bus line **CSAL** and that of the other region is connected to a storage capacitor trunk (CS trunk) **CSVtype2** by way of a CS bus line **CSBL**.

[0246] As shown in FIG. **36(b)**, each CS bus line is also provided for one of the two regions of each subpixel on a different row that is adjacent to the current row in the column direction. Specifically, the CS bus line **CSBL** is provided for not only respective regions **B** of the subpixels on the n^{th} row but also respective regions **A** of the subpixels on the $(n+1)^{\text{th}}$ row that is adjacent to the n^{th} row in the column direction.

[0247] In this liquid crystal display device **100D**, the direction of the electric field applied to the liquid crystal layer of each subpixel inverts at regular time intervals. As for the storage capacitor counter voltages **VCSVtype1** and **VCSVtype2** supplied to the CS trunks **CSVtype1** and **CSVtype2**, respectively, the first change of the voltage after the voltage on its associated arbitrary gate bus line has fallen from V_{GH} to V_{GL} is "increase" for the voltage **VCSVtype1** but "decrease" for the voltage **VCSVtype2**.

[0248] FIG. **37** is a schematic representation of this LCD panel **200D**. In FIG. **37**, "B (bright)" and "D (dark)" indicate whether a region of each subpixel is a bright region or a dark region, and "C1" and "C2" indicates whether a region of each subpixel is associated with the CS trunk **CSVtype1** or the CS trunk **CSVtype2**. Also, "+" and "-" indicate that the electric field applied to the liquid crystal layer has two different directions (i.e., two opposite polarities). That is to say, "+" indicates that the potential is higher at the counter electrode than at a subpixel electrode, while "-" indicates that the potential is higher at a subpixel electrode than at the counter electrode.

[0249] As can be seen from FIG. **37**, when attention is paid to one particular subpixel, one of the two regions thereof is associated with one of the CS trunks **CSVtype1** and **CSVtype2**, while the other region thereof is associated with the other CS trunk **CSVtype1** or **CSVtype2**. Also, look at the arrangement of subpixels, and it can be seen that any two pixels that are adjacent to each other in either the row direction or the column direction have two opposite polarities. That is to say, subpixels of opposite polarities are arranged on a subpixel-by-subpixel basis to form a checkered pattern. Furthermore, look at the respective regions of the subpixels on one row that are associated with the CS trunk **CSVtype1**, and it can be seen that their brightness and polarity both invert every region. In this manner, the bright and dark regions are also arranged so as to invert their brightness on a region-by-region basis. It should be noted that the state of the LCD panel **200D** in one frame is shown in FIG. **37**. In the next frame, however, the polarity of each region will be inverted, thereby minimizing the flicker.

[0250] Another liquid crystal display device will now be described as Comparative Example 3. The liquid crystal display device of Comparative Example 3 has the same configuration as the liquid crystal display device **100D** of this preferred embodiment except that the former device does not include the correcting section **300D**.

[0251] FIG. **38(a)** is a schematic representation illustrating how the liquid crystal display device of Comparative Example 3 looks when the input signal indicates that every pixel should represent a chromatic color. In this case, each subpixel is in ON state. In the liquid crystal display device of Comparative Example 3, any two regions that are adjacent to each other in the row or column direction have mutually different grayscale levels but each pair of diagonally adjacent regions has the same grayscale level. Also, the polarity is inverted on a subpixel-by-subpixel basis in the row and column directions. FIG. **38(b)** illustrates only blue subpixels of the liquid crystal display device of Comparative Example 3 for the sake of simplicity. Look at only the blue subpixels of the liquid crystal display device of Comparative Example 3, and it can be seen that any two regions that are adjacent to each other in the row or column direction have different luminance levels (or grayscale levels) and that the bright and dark regions are arranged in a checkered pattern.

[0252] Hereinafter, the liquid crystal display device **100D** of this fourth preferred embodiment will be described with reference to FIGS. **37**, **39**, **40** and **41**. In the following example, the input signal is supposed to indicate that at least blue subpixels should have the same grayscale level.

[0253] As described above, if the hue coefficient **H_b** is equal to zero, the blue correcting section **300b** does not make any correction. Look at only the blue subpixels of the LCD panel **200D** in such a situation, and it can be seen that the bright and dark regions of the blue subpixels are arranged in a checkered pattern so that the brightness level inverts on a region-by-region basis as shown in FIG. **39(a)**. Meanwhile, the polarity inverts on a subpixel-by-subpixel basis in both of the row and column directions. It should be noted that the LCD panel **200D** shown in FIG. **39(a)** is the same as the schematic representation of the liquid crystal display device of Comparative Example 3 shown in FIG. **38(b)**.

[0254] On the other hand, if the hue coefficient **H_b** is not zero (e.g., equal to one), then the blue correcting section **300b** controls the luminances using, as a unit, two blue subpixels belonging to two pixels that are adjacent to each other in the row direction so that bright blue subpixels are diagonally adjacent to each other. In that case, if attention is paid

to the brightness levels of those blue subpixels, it can be seen that the bright and dark blue subpixels are arranged in a checkered pattern on a blue subpixel basis. Thus, it can be said that the blue correcting section **300b** causes the respective blue subpixels to have the bright and dark pattern shown in FIG. **39(b)**. That is why in this LCD panel **200D**, the bright and dark regions of bright blue subpixels and those of dark blue subpixels are arranged as shown in FIG. **39(c)**. In this case, in two diagonally adjacent bright blue subpixels, their bright regions are arranged close to each other. And if those bright regions of bright blue subpixels are arranged unevenly in this manner, the display quality may decrease.

[0255] In the example just described, the blue correcting section **300b** is supposed to make a correction so that if the hue coefficient **Hb** is one, the blue subpixels change their brightness level every subpixel in both of the row and column directions. However, the present invention is in no way limited to that specific preferred embodiment. Alternatively, the blue correcting section **300b** may also make a correction so that the blue subpixels change their brightness level every other subpixel.

[0256] Hereinafter, it will be described with reference to FIG. **40** how the blue correcting section **300b** makes such a correction. If the hue coefficient **Hb** is equal to zero, the blue correcting section **300b** does not make any correction as described above. Look at only the blue subpixels of the LCD panel **200D** in such a situation, and it can be seen that the bright and dark regions of the blue subpixels are arranged in a checkered pattern so that the brightness level inverts on a region-by-region basis as shown in FIG. **40(a)**.

[0257] On the other hand, if the hue coefficient **Hb** is equal to one, then the blue correcting section **300b** makes a correction using, as a unit, two blue subpixels belonging to two pixels that are adjacent to each other in the row direction so that the blue subpixels change their brightness level every other subpixel in the row direction (i.e., two bright blue subpixels alternate with two dark subpixels every two subpixels in the row direction). Thus, it can be said that the blue correcting section **300b** causes the respective blue subpixels to have the bright and dark pattern shown in FIG. **40(b)**. In that case, the blue subpixels with "+" and "-" polarities include not only bright blue subpixels but also dark blue subpixels as well. That is why the unevenness of polarities and brightness levels can be reduced and the flicker can be minimized. Also, as a result of the correction made by the blue correcting section **300b**, in this LCD panel **200D**, the bright and dark regions of bright blue subpixels and those of dark blue subpixels are arranged as shown in FIG. **40(c)**. In this case, the respective bright regions of bright blue subpixels are arranged in line so as to be diagonally adjacent to each other. And if those bright regions of bright blue subpixels are arranged unevenly in this manner, the display quality may decrease.

[0258] In the example described above, the blue correcting section **300b** is supposed to make a correction so that if the hue coefficient **Hb** is equal to one, each blue subpixel becomes either a bright blue subpixel or a dark blue subpixel. However, this is only an example of the present invention. Even if the hue coefficient **Hb** is equal to one, the blue correcting section **300b** may also make a correction so that a portion of a blue subpixel becomes darker than a bright blue subpixel and brighter than a dark blue subpixel. Such a portion that is darker than a bright blue subpixel and brighter than a dark blue subpixel will be referred to herein as a "moderate blue subpixel".

[0259] Hereinafter, it will be described with reference to FIG. **41** how the blue correcting section **300b** makes such a correction. If the hue coefficient **Hb** is equal to zero, the blue correcting section **300b** does not make any correction as described above. Look at only the blue subpixels of the LCD panel **200D** in such a situation, and it can be seen that the bright and dark regions of the blue subpixels are arranged in a checkered pattern so that the brightness level inverts on a region-by-region basis as shown in FIG. **41(a)**.

[0260] On the other hand, if the hue coefficient **Hb** is equal to one, then the blue correcting section **300b** makes a correction using, as a unit, two blue subpixels that interpose another blue subpixel. In FIG. **41(b)**, four blue subpixels that are arranged in the row direction are identified by **B1**, **B2**, **B3** and **B4**, respectively. The blue correcting section **300b** controls luminances using the two blue subpixels **B1** and **B3** as a unit but does not make any correction on the other blue subpixels **B2** and **B4**. In that case, if attention is paid to the brightness levels of those blue subpixels that are arranged in the row direction, it can be seen that bright and dark blue subpixels are arranged alternately with a moderate blue subpixel interposed between them. Thus, it can be said that the blue correcting section **300b** causes the respective blue subpixels to have the bright and dark pattern shown in FIG. **41(b)**. That is why in this LCD panel **200D**, the bright and dark regions of bright, moderate and dark blue subpixels are arranged as shown in FIG. **41(c)**. If attention is paid to the brightness levels of a row of subpixels, a bright blue subpixel, a moderate blue subpixel, a dark blue subpixel and a moderate blue subpixel are arranged in this order. By having the blue correcting section **300b** make such a correction, it is possible to prevent the bright regions of bright blue subpixels from being arranged unevenly and a decrease in display quality can be minimized.

[0261] Hereinafter, the liquid crystal display device **100D** that makes a correction as shown in FIG. **41** will be described. FIG. **42(a)** is a schematic representation illustrating the LCD panel **200D** of this liquid crystal display device **100D**. As described above, in the LCD panel **200D**, each subpixel has multiple regions that may have mutually different luminances. However, illustration of those regions is omitted in FIG. **42(a)**. Also, shown in FIG. **42** are red, green and blue subpixels **R1**, **G1** and **B1** belonging to a pixel **P1**, red, green and blue subpixels **R2**, **G2** and **B2** belonging to a pixel **P2**, red, green and blue subpixels **R3**, **G3** and **B3** belonging to a pixel **P3**, and red, green and blue subpixels **R4**, **G4** and **B4** belonging to a pixel **P4**.

[0262] FIG. 42(b) is a schematic representation illustrating a blue correcting section 300b. In FIG. 42(b), the grayscale levels **r1**, **g1** and **b1** are indicated by the input signal for the subpixels **R1**, **G1** and **B1**, respectively, which belong to the pixel **P1** as shown in FIG. 42(a). The grayscale levels **r2**, **g2** and **b2** are indicated by the input signal for the subpixels **R2**, **G2** and **B2**, respectively, which belong to the pixel **P2**. Also, the grayscale levels **r3**, **g3** and **b3** are indicated by the input signal for the subpixels **R3**, **G3** and **B3**, respectively, which belong to the pixel **P3** as shown in FIG. 42(a). And the grayscale levels **r4**, **g4** and **b4** are indicated by the input signal for the subpixels **R4**, **G4** and **B4**, respectively, which belong to the pixel **P4**.

[0263] In the blue correcting section 300b, the average grayscale level b_{ave} of the grayscale levels **b1** and **b3** is calculated by using an adding section 310b. Next, a grayscale level difference section 320 calculates two grayscale level differences $\Delta b\alpha$ and $\Delta b\beta$ with respect to the single average grayscale level b_{ave} . Next, a grayscale-to-luminance converting section 330 converts the grayscale level differences $\Delta b\alpha$ and $\Delta b\beta$ into luminance level differences $\Delta Y_{b\alpha}$ and $\Delta Y_{b\beta}$, respectively.

[0264] Meanwhile, the average grayscale level r_{ave} of the grayscale levels **r1** and **r3** is calculated by using an adding section 310r. And the average grayscale level g_{ave} of the grayscale levels **g1** and **g3** is calculated by using an adding section 310g. Then, a hue determining section 340 calculates a hue coefficient **Hb** based on these average grayscale levels r_{ave} , g_{ave} and b_{ave} .

[0265] Next, the magnitudes of shift $\Delta S\alpha$ and $\Delta S\beta$ are calculated. In this case, the magnitude of shift $\Delta S\alpha$ is obtained as the product of $\Delta Y_{b\alpha}$ and the hue coefficient **Hb**, while the magnitude of shift $\Delta S\beta$ is obtained as the product of $\Delta Y_{b\beta}$ and the hue coefficient **Hb**. A multiplying section 350 multiplies the luminance level differences $\Delta Y_{b\alpha}$ and $\Delta Y_{b\beta}$ by the hue coefficient **Hb**, thereby obtaining the magnitudes of shift $\Delta S\alpha$ and $\Delta S\beta$.

[0266] Meanwhile, a grayscale-to-luminance converting section 360a carries out a grayscale-to-luminance conversion on the grayscale level **b1**, thereby obtaining a luminance level Y_{b1} . In the same way, another grayscale-to-luminance converting section 360b carries out a grayscale-to-luminance conversion on the grayscale level **b3**, thereby obtaining a luminance level Y_{b3} . Next, an adding and subtracting section 370a adds the luminance level Y_{b1} and the magnitude of shift $\Delta S\alpha$ together, and then the sum is subjected to luminance-to-grayscale conversion by a luminance-to-grayscale converting section 380a, thereby obtaining a grayscale level **b1'**. On the other hand, another adding and subtracting section 370b subtracts the magnitude of shift $\Delta S\beta$ from the luminance level Y_{b3} , and then the remainder is subjected to luminance-to-grayscale conversion by another luminance-to-grayscale converting section 380b, thereby obtaining a grayscale level **b3'**. No correction is made on the grayscale levels **r1** to **r4**, **g1** to **g4**, **b2**, and **b4**. By having the blue correcting section 300b make such a correction, it is possible to prevent the bright regions of bright blue subpixels from being arranged unevenly and a decrease in display quality can be minimized.

[0267] It is preferred that edge processing be further performed. FIG. 43 is a schematic representation illustrating an alternative correcting section 300b', which has the same configuration as the blue correcting section 300b except that this correcting section 300b' further includes the edge determining section 390 and coefficient calculating section 395 that have already been described with reference to FIG. 18. Thus, description of their common features will be omitted herein to avoid redundancies.

[0268] The edge determining section 390 obtains an edge coefficient **HE** based on the grayscale levels **b1** to **b4** indicated by the input signal. In this case, the edge coefficient is a function that increases as the difference between the grayscale levels **b1** to **b4** increases. And the edge coefficient **HE** may be represented as $HE = (\text{MAX}(b1, b2, b3, b4) - \text{MIN}(b1, b2, b3, b4)) / \text{MAX}(b1, b2, b3, b4)$, for example. However, the edge coefficient **HE** may also be obtained by any other method and may be calculated based on only the grayscale levels **b1** and **b3**.

[0269] Next, the coefficient calculating section 395 calculates a correction coefficient **HC** based on the hue coefficient **Hb** that has been obtained by the hue determining section 340 and the edge coefficient **HE** that has been obtained by the edge determining section 390. The correction coefficient **HC** may be represented as $HC = Hb - HE$, for example. The grayscale levels **b1** and **b3** are corrected just as described above using this correction coefficient **HC**. The edge processing may be performed in this manner.

(EMBODIMENT 5)

[0270] In the preferred embodiments described above, the luminances are supposed to be controlled by using, as a unit, two blue subpixels belonging to two pixels that are arranged in the row direction. However, the present invention is in no way limited to those specific preferred embodiments. Alternatively, the luminances may also be controlled by using, as a unit, two blue subpixels belonging to two pixels that are arranged in the column direction.

[0271] Hereinafter, a fifth specific preferred embodiment of a liquid crystal display device according to the present invention will be described with reference to FIG. 44. Specifically, FIG. 44(a) is a schematic representation illustrating a liquid crystal display device 100E according to this preferred embodiment. This liquid crystal display device 100E includes an LCD panel 200E and a correcting section 300E, which includes red, green and blue correcting sections 300r", 300g" and 300b".

[0272] FIG. 44(b) is a schematic representation illustrating the LCD panel 200E, in which each subpixel has multiple regions that may have mutually different luminances. A pixel P3 consisting of red, green and blue subpixels R3, G3 and B3 is arranged adjacent in the column direction to a pixel P1 consisting of red, green and blue subpixels R1, G1 and B1. Likewise, a pixel P4 consisting of red, green and blue subpixels R4, G4 and B4 is arranged adjacent in the column direction to a pixel P2 consisting of red, green and blue subpixels R2, G2 and B2.

[0273] Even in a situation where the blue correcting section 300b" controls the luminances by using, as a unit, two blue subpixels belonging to two pixels that are adjacent to each other in the column direction, if the blue correcting section 300b" gives the bright and dark pattern shown in FIG. 39(b) to the blue subpixels, then the bright regions of the bright blue subpixels will be arranged unevenly as shown in FIG. 39(c). That is why it is preferred that the blue correcting section 300b" give the bright and dark pattern shown in FIG. 41(b) to the blue subpixels.

[0274] Hereinafter, the blue correcting section 300b" of the liquid crystal display device 100E of this preferred embodiment will be described with reference to FIG. 45. As shown in FIG. 45(a), the blue correcting section 300b" includes first-stage line memories 300s, a grayscale control section 300t, and second-stage line memories 300u. The grayscale levels r1, g1 and b1 are indicated by the input signal for the subpixels R1, G1 and B1, respectively, which belong to the pixel P1 as shown in FIG. 44(b). The grayscale levels r2, g2 and b2 are indicated by the input signal for the subpixels R2, G2 and B2, respectively, which belong to the pixel P2. Also, the grayscale levels r3, g3 and b3 are indicated by the input signal for the subpixels R3, G3 and B3, respectively, which belong to the pixel P3 as shown in FIG. 44(b). And the grayscale levels r4, g4 and b4 are indicated by the input signal for the subpixels R4, G4 and B4, respectively, which belong to the pixel P4. The first-stage line memories 300s delay the input of the grayscale levels r1, g1, b1, r2, g2 and b2 to the grayscale control section 300t by one line.

[0275] FIG. 45(b) is a schematic representation illustrating the grayscale control section 300t. In the grayscale control section 300t, the average grayscale level b_{ave} of the grayscale levels b1 and b3 is calculated by using an adding section 310b. Next, a grayscale level difference section 320 calculates two grayscale level differences $\Delta b\alpha$ and $\Delta b\beta$ with respect to the single average grayscale level b_{ave} . Next, a grayscale-to-luminance converting section 330 converts the grayscale level differences $\Delta b\alpha$ and $\Delta b\beta$ into luminance level differences $\Delta Y_{b\alpha}$ and $\Delta Y_{b\beta}$, respectively.

[0276] Meanwhile, the average grayscale level r_{ave} of the grayscale levels r1 and r3 is calculated by using an adding section 310r. And the average grayscale level g_{ave} of the grayscale levels g1 and g3 is calculated by using an adding section 310g. Then, a hue determining section 340 calculates a hue coefficient Hb based on these average grayscale levels r_{ave} , g_{ave} and b_{ave} .

[0277] Next, a multiplying section 350 multiplies the luminance level differences $\Delta Y_{b\alpha}$ and $\Delta Y_{b\beta}$ by the hue coefficient Hb, thereby obtaining the magnitudes of shift $\Delta S\alpha$ and $\Delta S\beta$. Meanwhile, a grayscale-to-luminance converting section 360a carries out a grayscale-to-luminance conversion on the grayscale level b1, thereby obtaining a luminance level Y_{b1} . In the same way, another grayscale-to-luminance converting section 360b carries out a grayscale-to-luminance conversion on the grayscale level b3, thereby obtaining a luminance level Y_{b3} . Next, an adding and subtracting section 370a adds the luminance level Y_{b1} and the magnitude of shift $\Delta S\alpha$ together, and then the sum is subjected to luminance-to-grayscale conversion by a luminance-to-grayscale converting section 380a, thereby obtaining a grayscale level b1'. On the other hand, another adding and subtracting section 370b subtracts the magnitude of shift $\Delta S\beta$ from the luminance level Y_{b3} , and then the remainder is subjected to luminance-to-grayscale conversion by another luminance-to-grayscale converting section 380b, thereby obtaining a grayscale level b3'. By having the blue correcting section 300b" make such a correction, it is possible to prevent the bright regions of bright blue subpixels from being arranged unevenly and a decrease in display quality can be minimized.

[0278] It is preferred that edge processing be further performed. FIG. 46 is a schematic representation illustrating an alternative blue correcting section 300b', which has the same configuration as the blue correcting section 300b" shown in FIG. 45 except that this correcting section 300b' further includes the edge determining section 390 and coefficient calculating section 395 that have already been described with reference to FIG. 18. Thus, description of their common features will be omitted herein to avoid redundancies.

[0279] The edge determining section 390 obtains an edge coefficient HE based on the grayscale levels b1 to b3 indicated by the input signal. In this case, the edge coefficient HE may be represented as $HE = (\text{MAX}(b1, b3) - \text{MIN}(b1, b3)) / \text{MAX}(b1, b3)$, for example. However, the edge coefficient HE may also be obtained by any other method.

[0280] Next, the coefficient calculating section 395 calculates a correction coefficient HC based on the hue coefficient Hb that has been obtained by the hue determining section 340 and the edge coefficient HE that has been obtained by the edge determining section 390. The correction coefficient HC may be represented as $HC = Hb - HE$, for example. The grayscale levels b1 and b3 are corrected just as described above using this correction coefficient HC. The edge processing may be performed in this manner.

(EMBODIMENT 6)

[0281] In the first through fifth preferred embodiments of the present invention described above, a display operation

is supposed to be performed using three primary colors per pixel. However, the present invention is in no way limited to those specific preferred embodiments. Alternatively, a display operation may also be performed using four or more primary colors per pixel. For example, each pixel may include red, green, blue, yellow, cyan and magenta subpixels.

[0282] FIG. 47 is a schematic representation illustrating a liquid crystal display device as a sixth preferred embodiment of the present invention. The liquid crystal display device 100F of this preferred embodiment includes a multi-primary-color display panel 200F and a correcting section 300F. In the multi-primary-color display panel 200F, each pixel includes red (R), green (G), blue (B), and yellow (Ye) subpixels. The correcting section 300F includes red, green, blue and yellow correcting sections 300r, 300g, 300b and 300ye for controlling the luminances using two red, green, blue or yellow subpixels as a unit.

[0283] FIG. 48(a) is a schematic representation illustrating the multi-primary-color display panel 200F of this liquid crystal display device 100F. In the multi-primary-color display panel 200F, each pixel includes red (R), green (G), blue (B), and yellow (Ye) subpixels, which are arranged in this order in the row direction. In the column direction, on the other hand, subpixels representing the same color are arranged.

[0284] Hereinafter, the blue correcting section 300b will be described with reference to FIG. 49. The red, green and yellow correcting sections 300r, 300g and 300ye for making corrections on the grayscale levels R1 and R2, G1 and G2, and Ye1 and Ye2 that have been subjected to multi-primary-color conversion have the same configuration as the blue correcting section 300b, and a detailed description thereof will be omitted herein.

[0285] The blue correcting section 300b has the same configuration as its counterpart that has already been described with reference to FIG. 8 except that the blue correcting section 300b further includes a multi-primary-color converting section 400. And description of their common features will be omitted herein to avoid redundancies. The multi-primary-color converting section 400 obtains grayscale levels R1, G1, B1, and Ye1 for the respective subpixels of each pixel in the LCD panel 200F based on the grayscale levels r1, g1 and b1 of the input signal, and also obtains grayscale levels R2, G2, B2, and Ye2 for the respective subpixels of each pixel in the LCD panel 200F based on the grayscale levels r2, g2 and b2 of the input signal. The grayscale levels R1, G1, B1 and Ye1 are indicated for the respective subpixels belonging to the pixel P1 shown in FIG. 48(a). On the other hand, the grayscale levels R2, G2, B2 and Ye2 are indicated for the respective subpixels belonging to the pixel P2.

[0286] The average of the grayscale levels B1 and B2 is calculated by using an adding section 310B. In the following description, the average of the grayscale levels B1 and B2 will be referred to herein as an average grayscale level B_{ave} . Next, a grayscale level difference section 320 calculates two grayscale level differences $\Delta B\alpha$ and $\Delta B\beta$ with respect to the single average grayscale level B_{ave} . The grayscale level differences $\Delta B\alpha$ and $\Delta B\beta$ are associated with a bright blue subpixel and a dark blue subpixel, respectively. Next, a grayscale-to-luminance converting section 330 converts the grayscale level differences $\Delta B\alpha$ and $\Delta B\beta$ into luminance level differences $\Delta Y_{B\alpha}$ and $\Delta Y_{B\beta}$, respectively.

[0287] Meanwhile, the averages of the three pairs of grayscale levels r1 and r2, g1 and g2, and b1 and b2 are calculated by adding sections 310r, 310g and 310b, respectively. In the following description, those averages of the three pairs of grayscale levels r1 and r2, g1 and g2, and b1 and b2 will be referred to herein as average grayscale levels r_{ave} , g_{ave} , and b_{ave} , respectively.

[0288] The hue determining section 340 determines the hue of the color to be represented by a pixel in accordance with the input signal. Specifically, the hue determining section 340 obtains a hue coefficient Hb by using average grayscale levels r_{ave} , g_{ave} and b_{ave} . The hue coefficient Hb is a function that varies according to the hue.

[0289] Alternatively, the hue determining section 340 may also obtain the hue coefficient Hb based on the average grayscale levels R_{ave} , G_{ave} , B_{ave} and Ye_{ave} . In that case, since R_{ave} , G_{ave} , B_{ave} and Ye_{ave} correspond to the average grayscale levels that have been obtained based on the grayscale levels indicated by the input signal, correction on the blue subpixel is made indirectly according to the hue of the color to be represented by a pixel in accordance with the input signal. Nevertheless, as the hue can be determined sufficiently accurately by using the average grayscale levels r_{ave} , g_{ave} and b_{ave} , the complexity of processing can be minimized.

[0290] Next, the magnitudes of shift $\Delta S\alpha$ and $\Delta S\beta$ are calculated. In this case, the magnitude of shift $\Delta S\alpha$ is obtained as the product of $\Delta Y_{B\alpha}$ and the hue coefficient Hb , while the magnitude of shift $\Delta S\beta$ is obtained as the product of $\Delta Y_{B\beta}$ and the hue coefficient Hb . A multiplying section 350 multiplies the luminance level differences $\Delta Y_{B\alpha}$ and $\Delta Y_{B\beta}$ by the hue coefficient Hb , thereby obtaining the magnitudes of shift $\Delta S\alpha$ and $\Delta S\beta$.

[0291] Meanwhile, a grayscale-to-luminance converting section 360a carries out a grayscale-to-luminance conversion on the grayscale level B1, thereby obtaining a luminance level Y_{B1} , which can be calculated by the following equation:

$$Y_{B1} = B1^{2.2} \quad (\text{where } 0 \leq B1 \leq 1)$$

[0292] In the same way, another grayscale-to-luminance converting section 360b carries out a grayscale-to-luminance

conversion on the grayscale level **B2**, thereby obtaining a luminance level Y_{B2} .

[0293] Next, an adding and subtracting section **370a** adds the luminance level Y_{B1} and the magnitude of shift $\Delta S\alpha$ together, and then the sum is subjected to luminance-to-grayscale conversion by a luminance-to-grayscale converting section **380a**, thereby obtaining a grayscale level **B1'**. On the other hand, another adding and subtracting section **370b** subtracts the magnitude of shift $\Delta S\beta$ from the luminance level Y_{B2} , and then the remainder is subjected to luminance-to-grayscale conversion by another luminance-to-grayscale converting section **380b**, thereby obtaining a grayscale level **B2'**.

[0294] As described above, in this liquid crystal display device **100F**, the luminances are controlled by using, as a unit, two blue subpixels belonging to two pixels that are adjacent to each other in the column direction. In FIG. **48(b)**, those pairs of blue subpixels, of which the luminances need to be controlled, are indicated by the arrows. Strictly speaking, the luminances of red, green, and yellow subpixels may also be controlled. However, only two blue subpixels, of which the luminances need to be controlled, are described herein to avoid redundancies. In FIG. **48(b)**, the non-shadowed blue subpixels are bright blue subpixels and the shadowed ones are dark blue subpixels.

[0295] In the multi-primary-color display panel **200F** shown in FIG. **48**, subpixels to represent the same color are arranged in the column direction. However, the present invention is in no way limited to that specific preferred embodiment. Alternatively, subpixels representing mutually different colors may also be arranged in the column direction. In that case, using two blue subpixels belonging to two pixels that are adjacent to each other in the column direction as a unit, the luminances may be controlled so that bright blue subpixels are arranged in the row direction. Consequently, it is possible to prevent the bright blue subpixels from being arranged unevenly and a substantial decrease in the resolution of the color blue can be minimized.

[0296] Also, in the multi-primary-color display panel **200F** shown in FIG. **48**, subpixels belonging to a single pixel are arranged in a row. However, this is just an example of the present invention. Alternatively, subpixels belonging to a single pixel may also be arranged in multiple rows.

[0297] FIG. **50(a)** is a schematic representation illustrating a multi-primary-color display panel **200F1** for a liquid crystal display device **100F1**. In this multi-primary-color display panel **200F1**, subpixels included in a single pixel are arranged in two columns and two rows. Specifically, red and green subpixels belonging to the same pixel are arranged in this order in a row in the row direction and blue and yellow subpixels belonging to that pixel are arranged in this order in an adjacent row in the row direction. Look at the arrangement of subpixels in the column direction, and it can be seen that red and blue subpixels are arranged alternately and green and yellow subpixels are also arranged alternately. As shown in FIG. **50(b)**, in this liquid crystal display device **100F1**, the luminances are controlled by using, as a unit, two blue subpixels belonging to two pixels that are adjacent to each other in the row direction so that bright blue subpixels are diagonally adjacent to each other.

[0298] In the multi-primary-color display panels **200F** and **200F1** shown in FIGS. **48** and **50**, each pixel consists of red, green, blue and yellow subpixels. However, this is only an example of the present invention. Alternatively, each pixel may include a white subpixel instead of the yellow subpixel. It should be noted that those four subpixels do not always have to be arranged in that order. Nevertheless, at least the subpixels that need to have their grayscale levels corrected (e.g., blue subpixels in this preferred embodiment) are preferably arranged at regular intervals over multiple pixels.

[0299] In the multi-primary-color display panels **200F** and **200F1** described above, a single pixel is supposed to consist of four subpixels. However, the present invention is in no way limited to that specific preferred embodiment. Optionally, in another multi-primary-color display panel, each pixel may also consist of six subpixels.

[0300] FIG. **51(a)** is a schematic representation illustrating such a multi-primary-color display panel **200F2**. In the multi-primary-color display panel **200F2**, each pixel consists of red (R), green (G), blue (B), yellow (Ye), cyan (C) and magenta (M) subpixels. Although not shown in FIG. **51(a)**, the correcting section **300F** preferably includes not only the red, green, blue and yellow correcting sections **300r**, **300g**, **300b** and **300ye** but also cyan and magenta correcting sections **300c** and **300m** as well. In the multi-primary-color display panel **200F2**, the red, green, blue, yellow, magenta and cyan subpixels belonging to the same pixel are arranged in this order in the row direction and subpixels representing the same color are arranged in the column direction.

[0301] In FIG. **51(a)**, subpixels to represent the same color are arranged in the column direction. However, the present invention is in no way limited to that specific preferred embodiment. Alternatively, subpixels representing mutually different colors may also be arranged in the column direction. In that case, using two blue subpixels belonging to two pixels that are adjacent to each other in the column direction as a unit, the luminances may be controlled so that bright blue subpixels are arranged in the row direction. Consequently, it is possible to prevent the bright blue subpixels from being arranged unevenly and a substantial decrease in the resolution of the color blue can be minimized. For example, red, green, magenta, cyan, blue and yellow subpixels belonging to one pixel may be arranged in this order in a row and cyan, blue, yellow, red, green and magenta subpixels belonging to another pixel may be arranged in this order in the next adjacent row.

[0302] Also, in the multi-primary-color display panel **200F2** shown in FIG. **51**, subpixels belonging to a single pixel are arranged in a row. However, this is just an example of the present invention. Alternatively, subpixels belonging to a

single pixel may also be arranged in multiple rows.

[0303] FIG. 52(a) is a schematic representation illustrating a multi-primary-color display panel **200F3** for a liquid crystal display device **100F3**. In this multi-primary-color display panel **200F3**, subpixels included in a single pixel are arranged in three columns and two rows. Specifically, red, green and blue subpixels belonging to the same pixel are arranged in this order in a row in the row direction and yellow, magenta and cyan subpixels belonging to that pixel are arranged in this order in an adjacent row in the row direction. Look at the arrangement of subpixels in the column direction, and it can be seen that red and yellow subpixels are arranged alternately, green and magenta subpixels are arranged alternately, and blue and cyan subpixels are also arranged alternately. Alternatively, red and cyan subpixels may be arranged alternately, green and magenta subpixels may be arranged alternately, and blue and yellow subpixels may be arranged alternately.

[0304] As shown in FIG. 52(b), in this liquid crystal display device **100F3**, the luminances are controlled by using, as a unit, two blue subpixels belonging to two pixels that are adjacent to each other in the row direction so that bright and dark blue subpixels alternate with each other in the row direction.

[0305] It should be noted that those six subpixels do not always have to be arranged in that order. Nevertheless, at least the subpixels that need to have their grayscale levels corrected (e.g., blue subpixels in this preferred embodiment) are preferably arranged at regular intervals over multiple pixels. Also, in the multi-primary-color display panels **200F2** and **200F3**, each pixel consists of red, green, blue, yellow, cyan and magenta subpixels. However, this is just an example of the present invention. Alternatively, each pixel may also consist of first red, green, blue, yellow, cyan and second red subpixels.

[0306] Furthermore, in the preferred embodiments described above, each of the correcting sections **300B**, **300C**, **300D**, **300E** and **300F** is supposed to include red, green, blue, yellow, cyan, and/or magenta correcting sections **300r**, **300g**, **300b**, **300ye**, **300c** and **300m**. However, this is only an example of the present invention. As already described with reference to FIG. 19, each of these correcting sections may include at least one of the red, green, blue, yellow, cyan, and/or magenta correcting sections **300r**, **300g**, **300b**, **300ye**, **300c** and **300m**.

[0307] Furthermore, in the preferred embodiments described above, the liquid crystal layer is supposed to be a vertical alignment liquid crystal layer. However, the present invention is in no way limited to those specific preferred embodiments. If necessary, a liquid crystal layer of any other mode may also be used.

[0308] The entire disclosures of Japanese Patent Applications Nos. 2008-335246 and 2009-132500, from which the present application claims priority, are hereby incorporated by reference.

INDUSTRIAL APPLICABILITY

[0309] The present invention provides a liquid crystal display device that can improve the viewing angle characteristic and minimize a decline in display quality.

REFERENCE SIGNS LIST

[0310]

100 liquid crystal display device
200 LCD panel
300 correcting section

Claims

1. A liquid crystal device comprising multiple pixels including first and second pixels that are arranged adjacent to each other, wherein each said pixel includes a number of subpixels including first, second and third subpixels, and wherein if an input signal indicates that each of the first and second pixels should represent a particular chromatic color, not only the third subpixel of at least one of the first and second pixels but also at least one of the respective first and second subpixels of the first and second pixels turn ON, and wherein if the average luminance of the respective third subpixels of the first and second pixels in one situation where the input signal indicates that each of the first and second pixels should represent the chromatic color is substantially equal to that of the respective third subpixels of the first and second pixels in another situation where the input signal indicates that each of the first and second pixels should represent an achromatic color, the luminances of the respective third subpixels of the first and second pixels in the former situation are different from those of the respective third subpixels of the first and second pixels in the latter situation.

2. The liquid crystal device of claim 1, wherein the first, second and third subpixels are red, green and blue subpixels, respectively.
- 5 3. The liquid crystal device of claim 1 or 2, wherein if the average luminance of the respective first subpixels of the first and second pixels in one situation where the input signal indicates that each of the first and second pixels should represent another chromatic color is equal to that of the respective first subpixels of the first and second pixels in another situation where the input signal indicates that each of the first and second pixels should represent an achromatic color, the luminances of the respective first subpixels of the first and second pixels in the former situation are different from those of the respective first subpixels of the first and second pixels in the latter situation.
- 10 4. The liquid crystal device of one of claims 1 to 3, wherein if the average luminance of the respective second subpixels of the first and second pixels in one situation where the input signal indicates that each of the first and second pixels should represent still another chromatic color is equal to that of the respective second subpixels of the first and second pixels in another situation where the input signal indicates that each of the first and second pixels should represent an achromatic color, the luminances of the respective second subpixels of the first and second pixels in the former situation are different from those of the respective second subpixels of the first and second pixels in the latter situation.
- 15 5. The liquid crystal device of one of claims 1 to 4, further comprising:
- 20 first, second and third subpixel electrodes that define the first, second and third subpixels, respectively; and source bus lines, which are provided for the first, second and third subpixel electrodes, respectively.
- 25 6. The liquid crystal device of one of claims 1 to 4, wherein each of the first, second and third subpixels has multiple regions that are able to have mutually different luminances.
- 30 7. The liquid crystal device of claim 6, further comprising:
- first, second and third subpixel electrodes, which define the first, second and third subpixels, respectively, and each of which has divided electrodes that define the multiple regions; source bus lines, which are provided for the first, second and third subpixel electrodes, respectively; and storage capacitor bus lines, which are provided for the respective divided electrodes of the first, second and third subpixel electrodes.
- 35 8. The liquid crystal device of one of claims 1 to 7, wherein either the input signal or a signal obtained by converting the input signal indicates the respective grayscale levels of the multiple subpixels that are included in each of the multiple pixels, and wherein the grayscale levels of the respective third subpixels of the first and second pixels, which are indicated by either the input signal or the converted signal, are corrected according to the hues of the first and second pixels that are also indicated by the input signal.
- 40 9. The liquid crystal device of one of claims 1 to 7, wherein either the input signal or a signal obtained by converting the input signal indicates the respective grayscale levels of the multiple subpixels that are included in each of the multiple pixels, and wherein the grayscale levels of the respective third subpixels of the first and second pixels, which are indicated by either the input signal or the converted signal, are corrected according to not only the hues of the first and second pixels that are also indicated by the input signal but also a difference in grayscale level between the respective third subpixels of the first and second pixels, which is also indicated by the input signal.
- 45 10. The liquid crystal device of one of claims 1 to 9, wherein if the input signal indicates that the third subpixel of one of the first and second pixels has a first grayscale level and that the third subpixel of the other pixel has either the first grayscale level or a second grayscale level, which is higher than the first grayscale level, then the luminances of the respective third subpixels of the first and second pixels are different from ones that are associated with the grayscale levels indicated by either the input signal or the signal obtained by converting the input signal, and wherein if the input signal indicates that the third subpixel of the one pixel has the first grayscale level and that the third subpixel of the other pixel has a third grayscale level, which is higher than the second grayscale level, then the luminances of the respective third subpixels of the first and second pixels are substantially equal to ones that are associated with the grayscale levels indicated by either the input signal or the signal obtained by converting the
- 50 55

input signal.

- 5 11. A liquid crystal device comprising a pixel that has a number of subpixels including first, second and third subpixels, wherein each of the first, second and third subpixels has a number of regions including first and second regions that are able to have mutually different luminances, and wherein if an input signal indicates that the pixel should represent a particular chromatic color, not only at least one of the first and second regions of the third subpixel but also at least one of the respective first and second regions of the first and second subpixels turn ON, and wherein if the average luminance of the first and second regions of the third subpixel in one situation where the input signal indicates that the pixel should represent the chromatic color is equal to that of the first and second regions of the third subpixel in another situation where the input signal indicates that the pixel should represent an achromatic color, the respective luminances of the first and second regions of the third subpixel in the former situation are different from those of the first and second regions of the third subpixel in the latter situation.
- 10
- 15 12. The liquid crystal device of claim 11, wherein the first, second and third subpixels are red, green and blue subpixels, respectively.
13. The liquid crystal device of claim 11 or 12, further comprising:
- 20 first, second and third subpixel electrodes, which define the first, second and third subpixels, respectively, and each of which has first and second divided electrodes that define the first and second regions, respectively; and source bus lines, which are provided for the first and second divided electrodes of the first, second and third subpixel electrodes, respectively.
- 25 14. The liquid crystal device of claim 11 or 12, further comprising:
- 30 first, second and third subpixel electrodes, which define the first, second and third subpixels, respectively, and each of which has first and second divided electrodes that define the first and second regions, respectively; source bus lines, which are provided for the first, second and third subpixel electrodes, respectively; and gate bus lines, which are provided for the respective first and second divided electrodes of the first, second and third subpixel electrodes.
- 35 15. A liquid crystal display device comprising multiple pixels that are arranged in columns and rows to form a matrix pattern, wherein the multiple pixels include first, second, third and fourth pixels, which are arranged in this order along either one of the columns or one of the rows, and wherein each of the pixels has a number of subpixels including first, second and third subpixels, and wherein if an input signal indicates that each of the first and third pixels should represent a particular chromatic color, not only the third subpixel of at least one of the first and third pixels but also at least one of the respective first and second subpixels of the first and third pixels turn ON, and wherein if the average luminance of the respective third subpixels of the first and third pixels in one situation where the input signal indicates that the first and third pixels should represent the chromatic color is substantially equal to that of the respective third subpixels of the first and third pixels in another situation where the input signal indicates that the first and third pixels should represent an achromatic color, the luminances of the respective third subpixels of the first and third pixels in the former situation are different from those of the respective third subpixels of the first and third pixels in the latter situation.
- 40
- 45
- 50 16. The liquid crystal device of claim 15, wherein the luminance of the respective third subpixels of the second and fourth pixels is substantially equal to a one that is associated with a grayscale level indicated by either the input signal or a signal obtained by converting the input signal.

55

FIG. 1

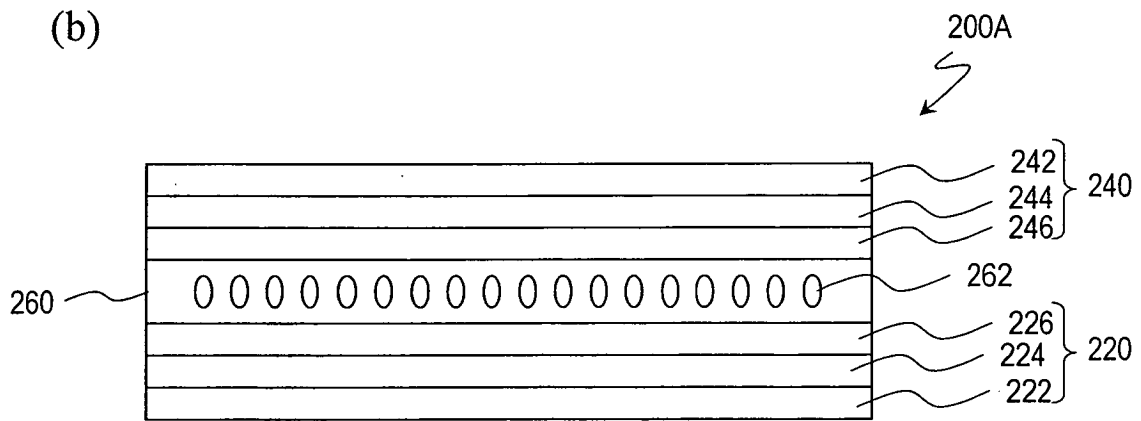
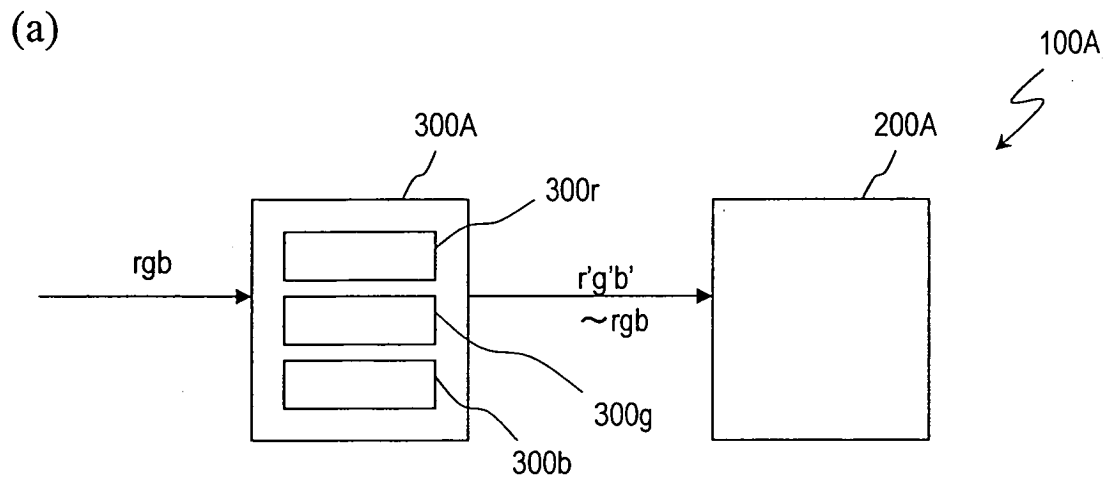

FIG. 2

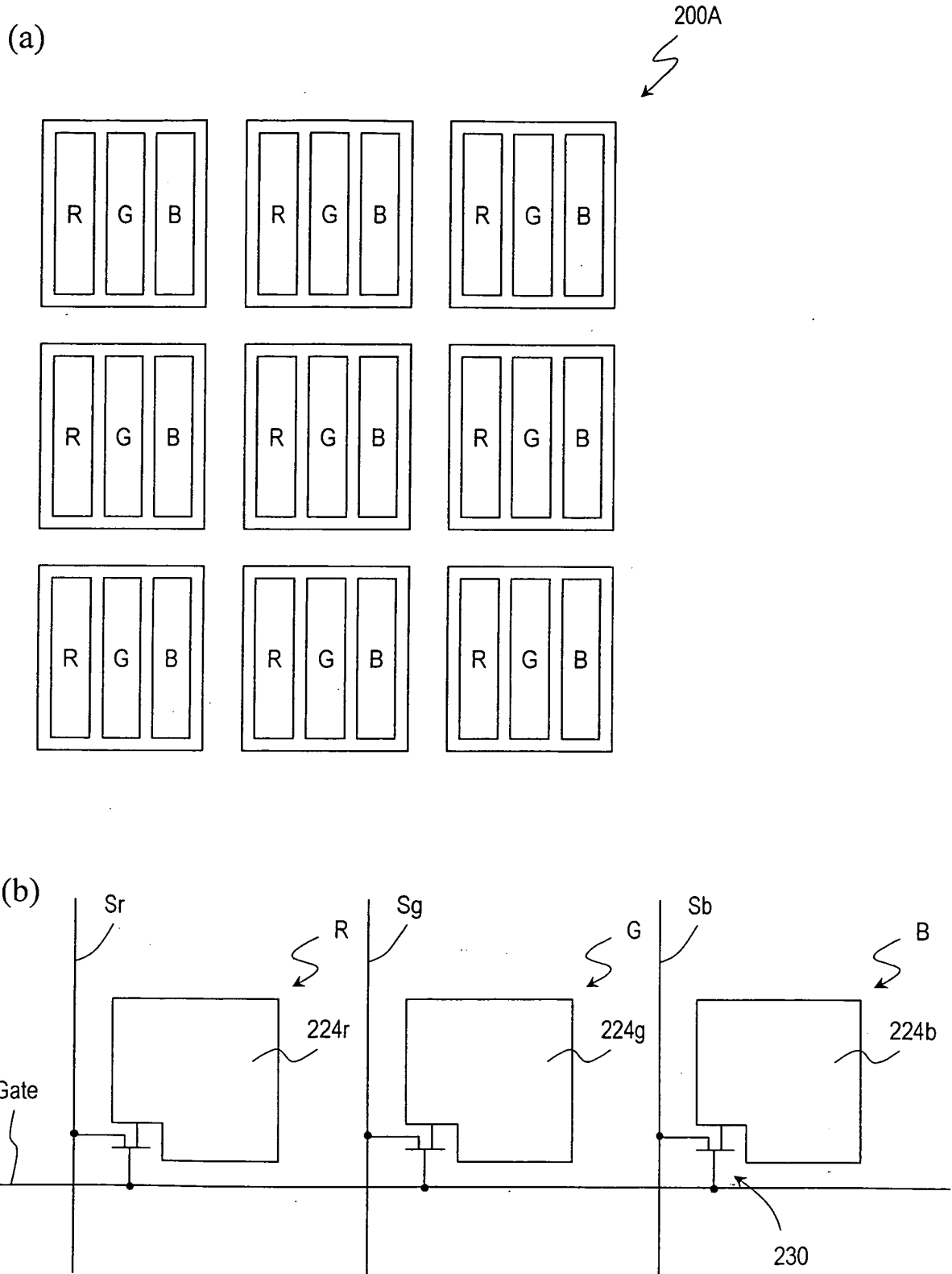

FIG. 3

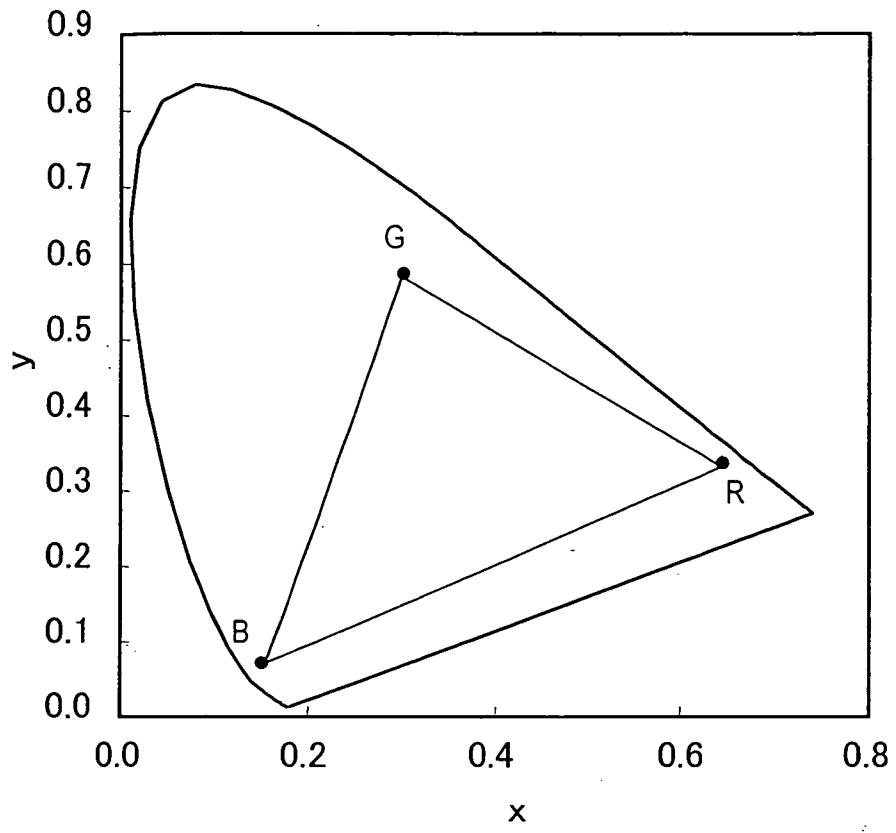

FIG. 4

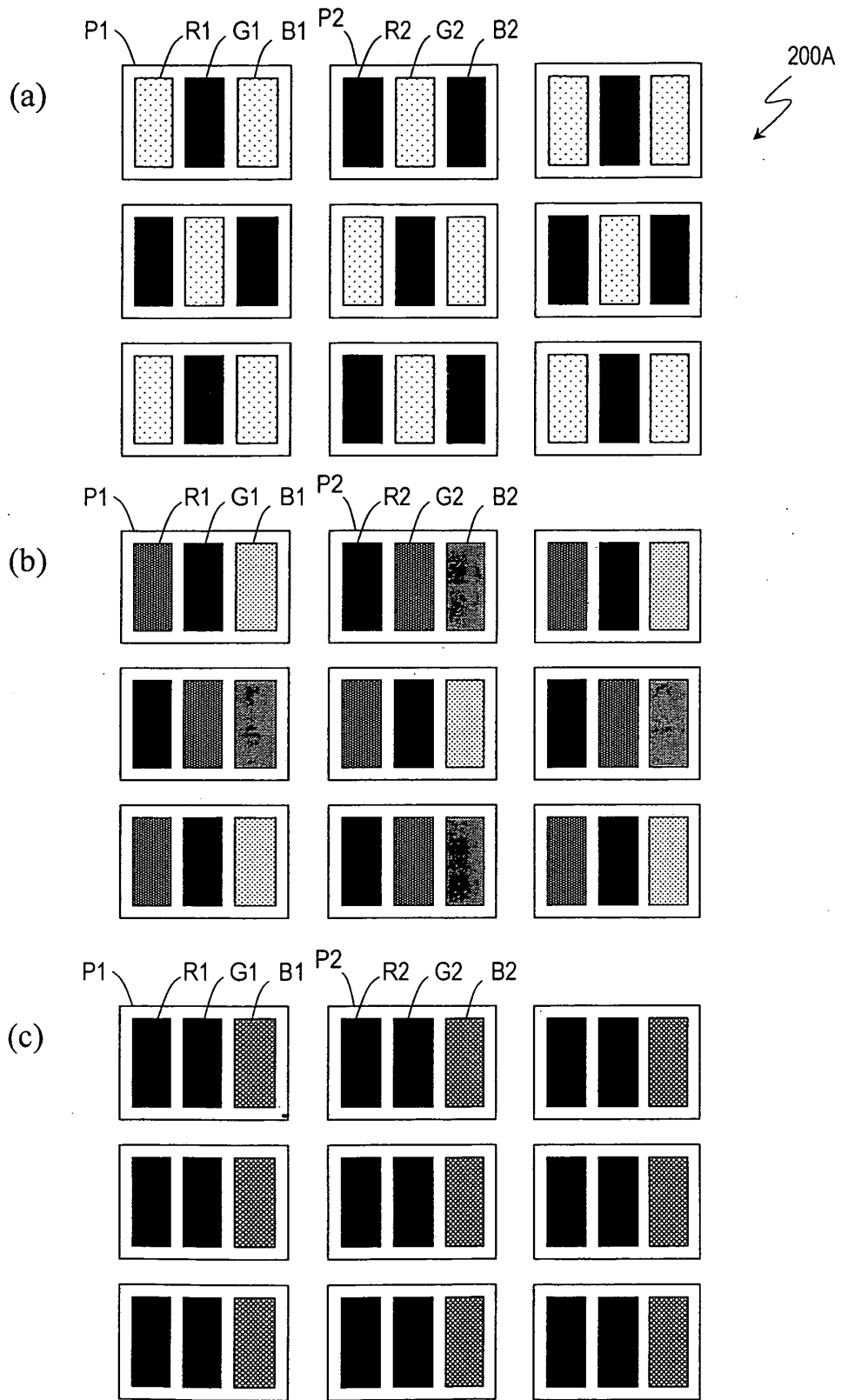

FIG. 5

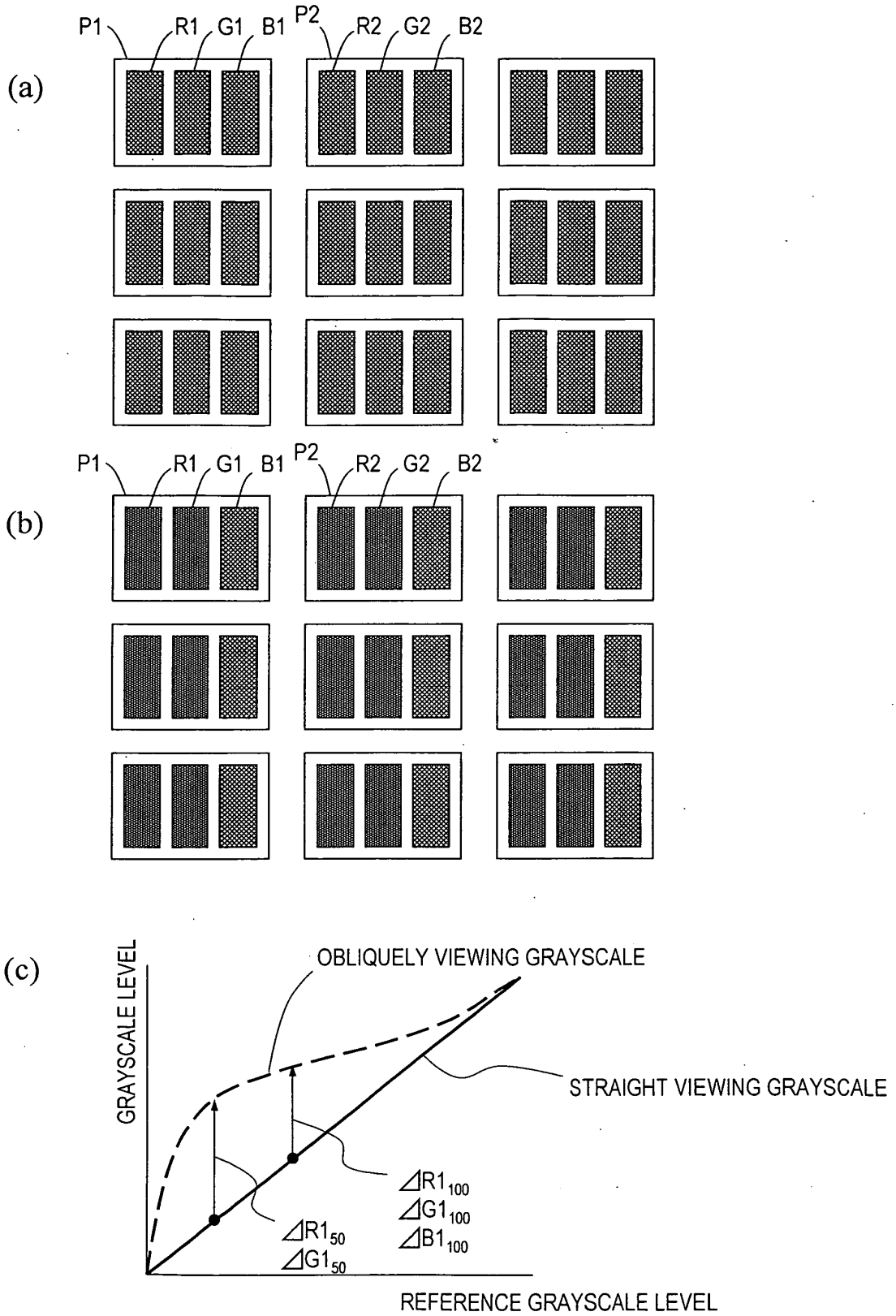

FIG. 6

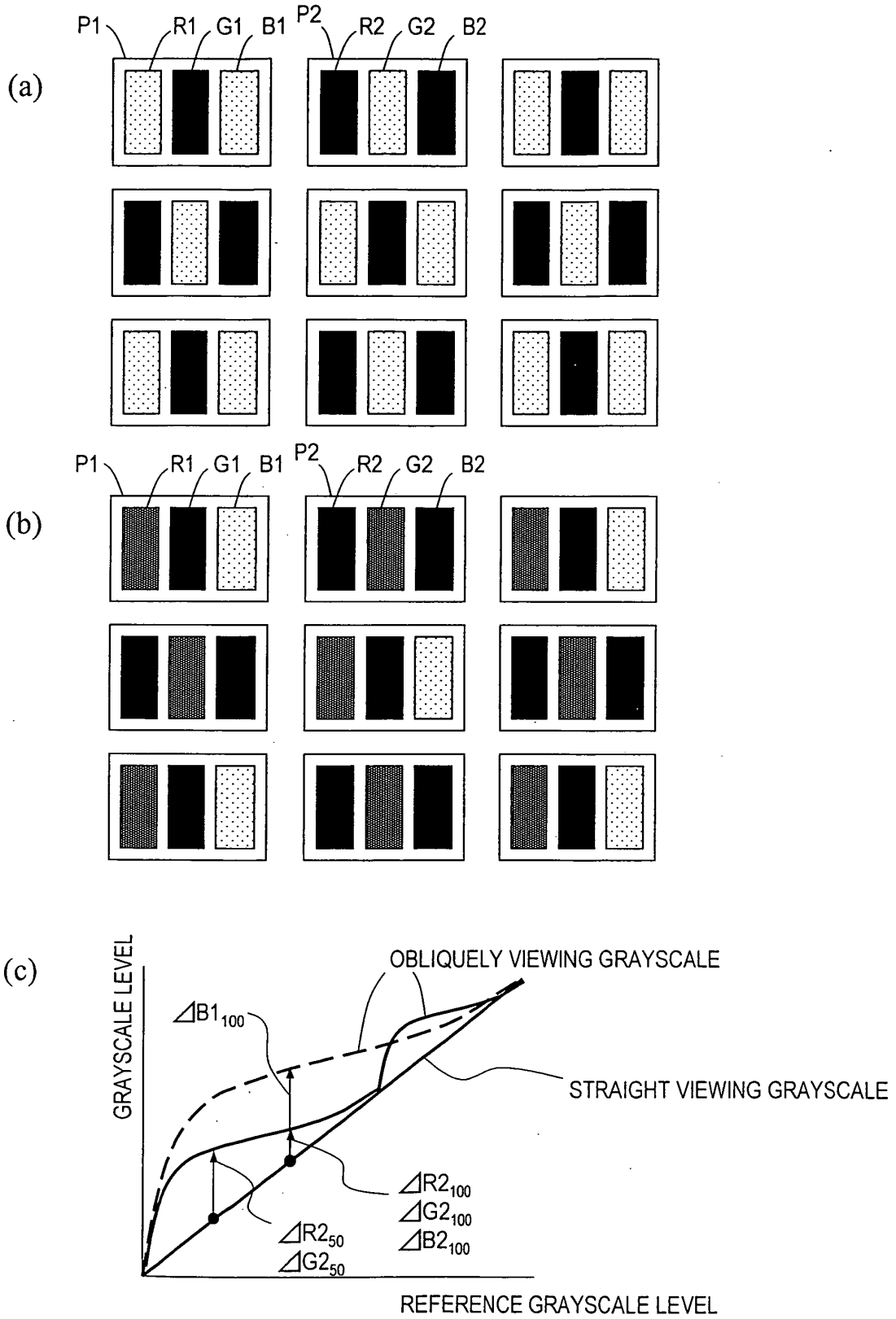

FIG. 7

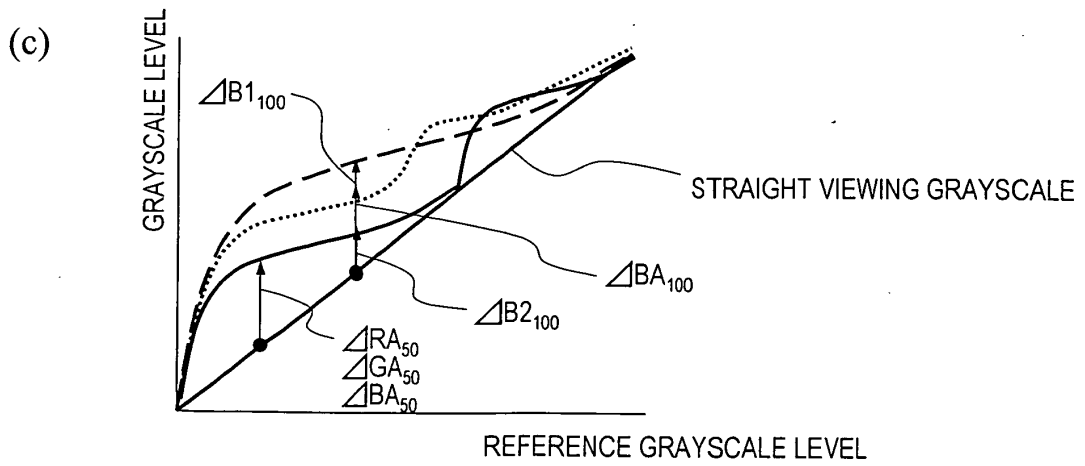
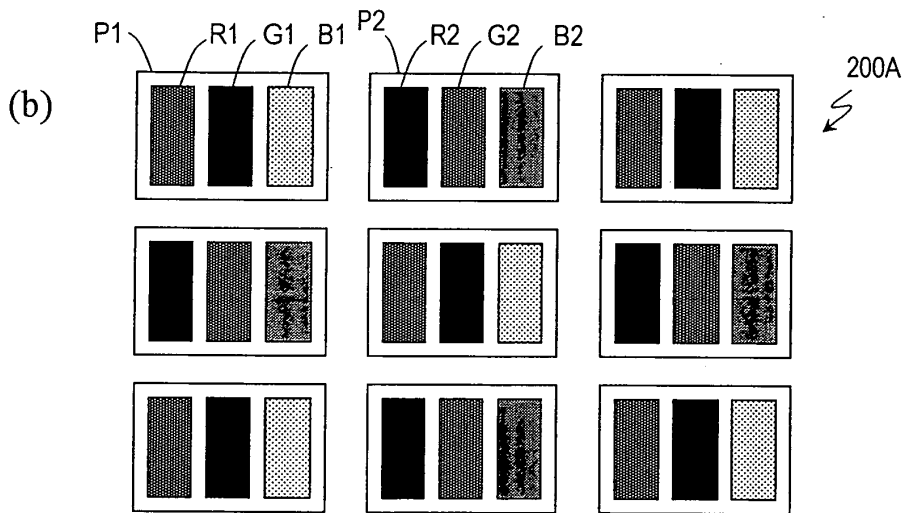
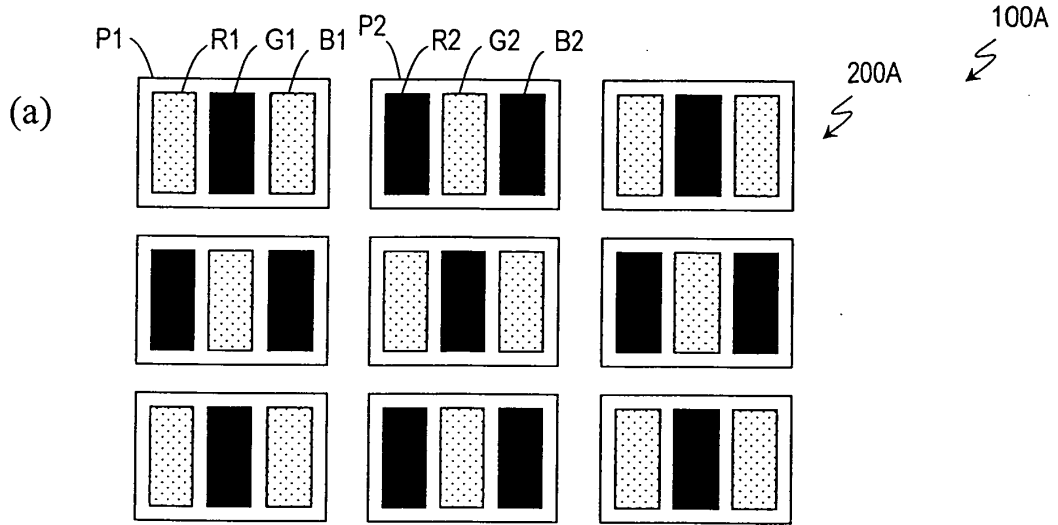

FIG. 8

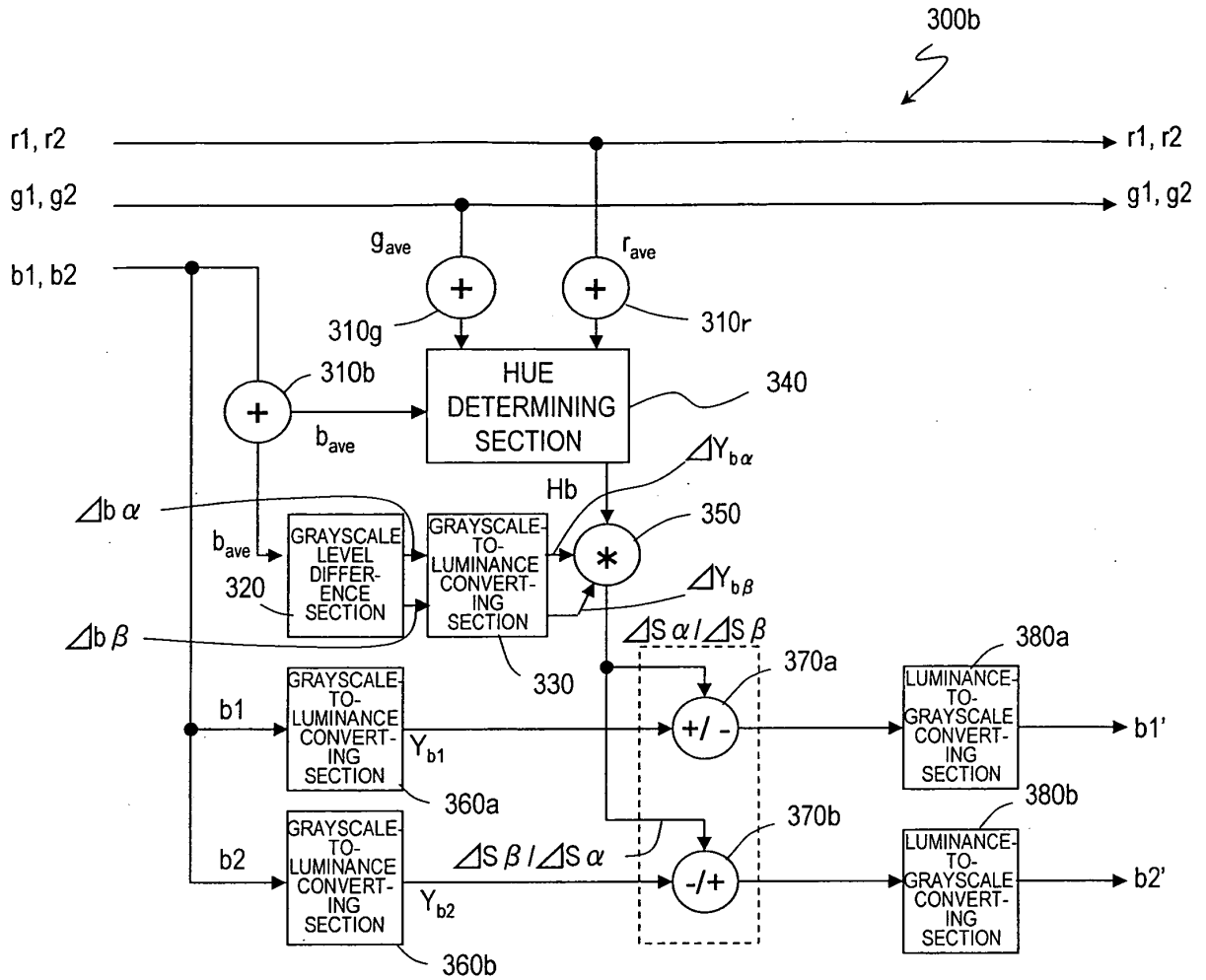
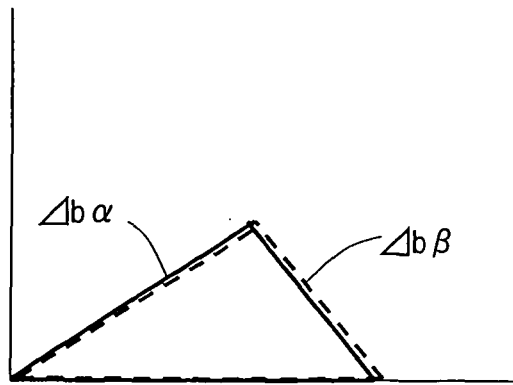

FIG. 9

(a)



(b)

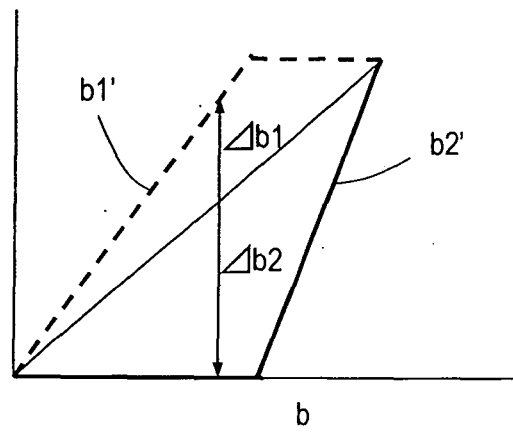

FIG. 10

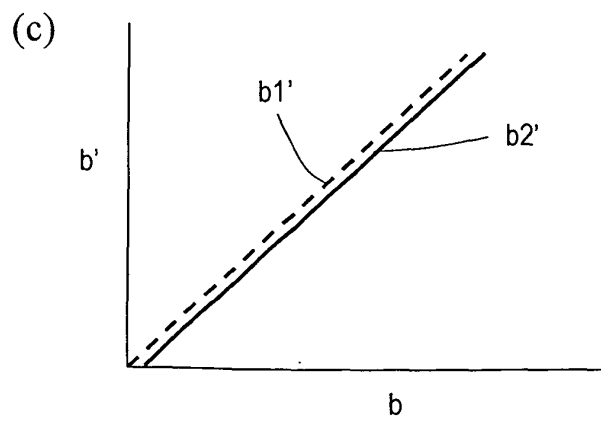
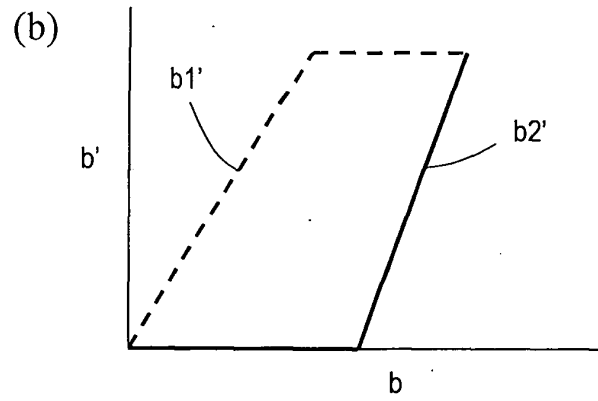
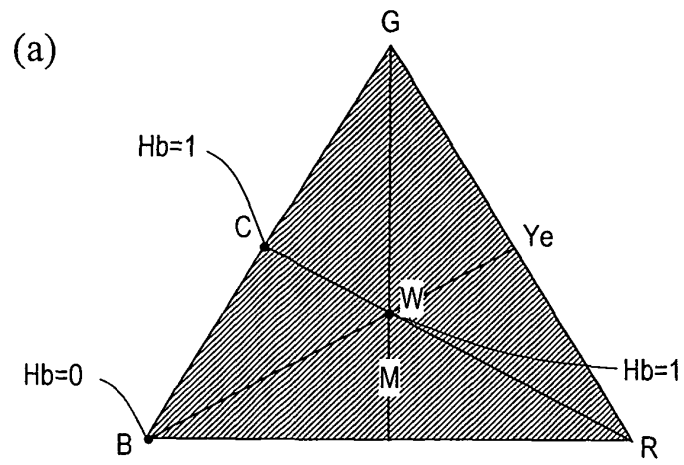
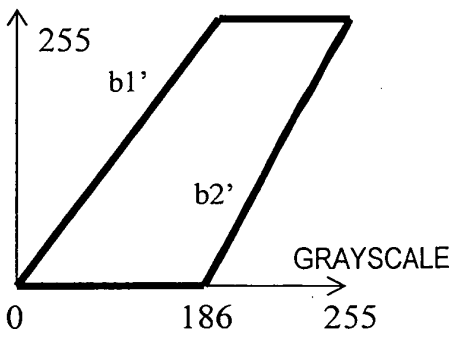
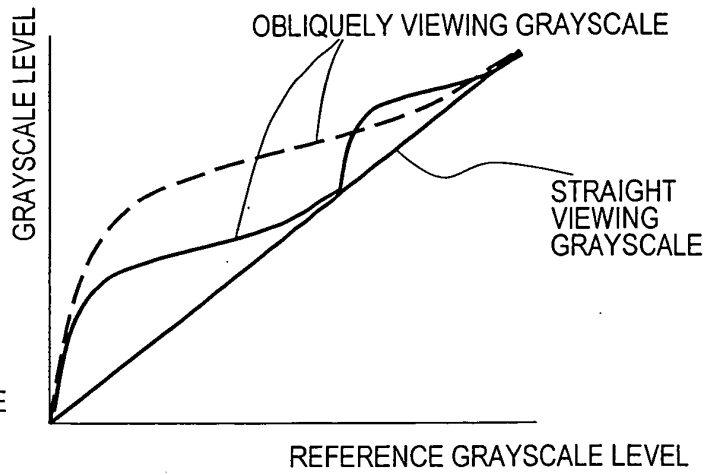

FIG. 11

(a)



(b)



(c)

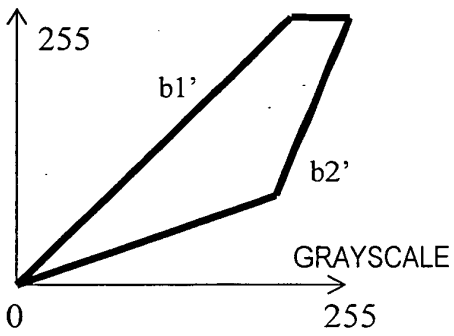

(d)

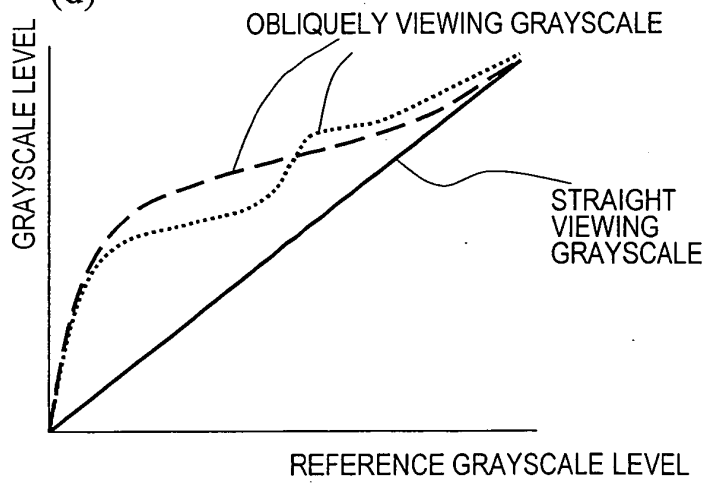

FIG.12

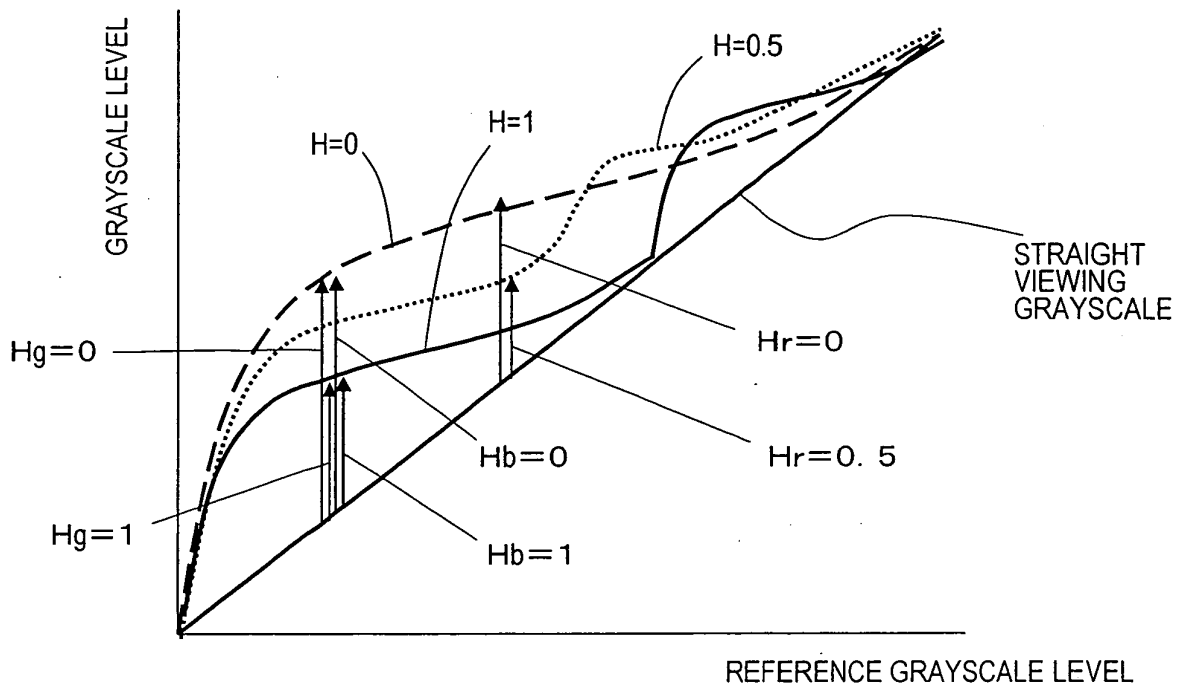
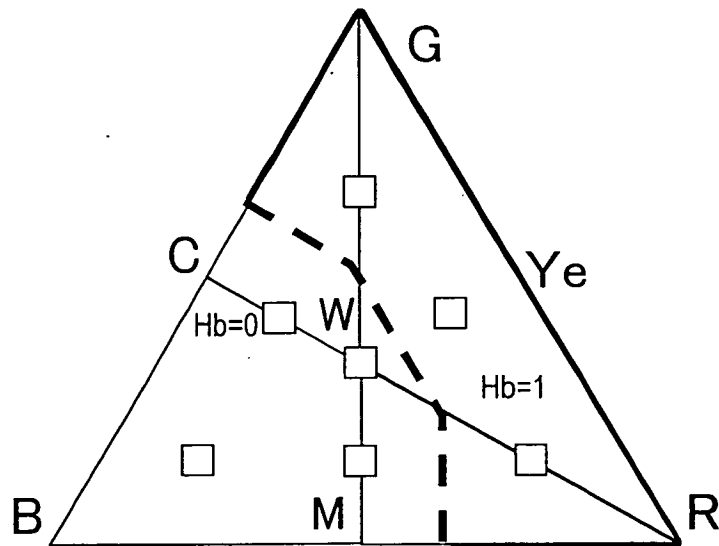
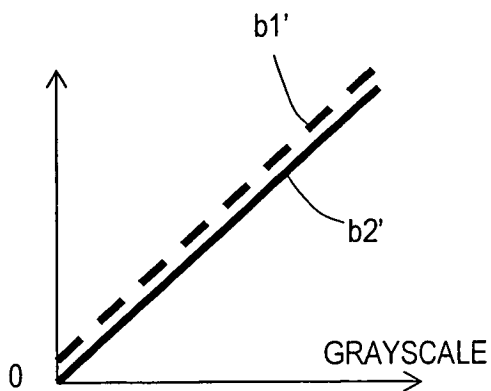

FIG. 13

(a)



(b)



(c)

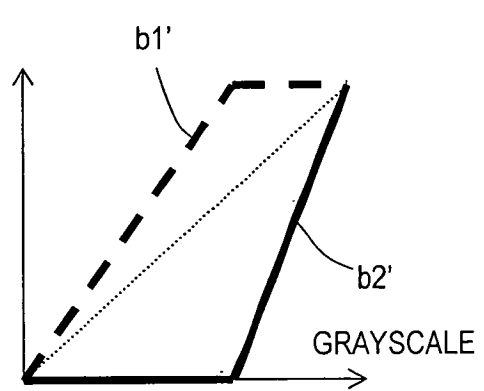
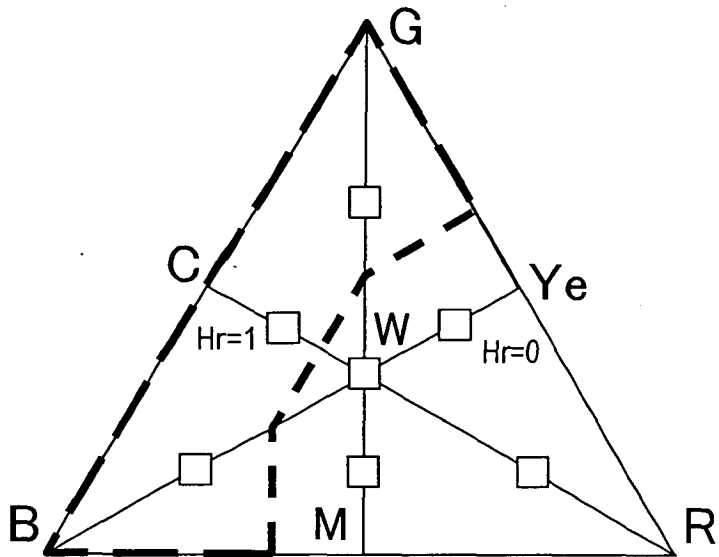
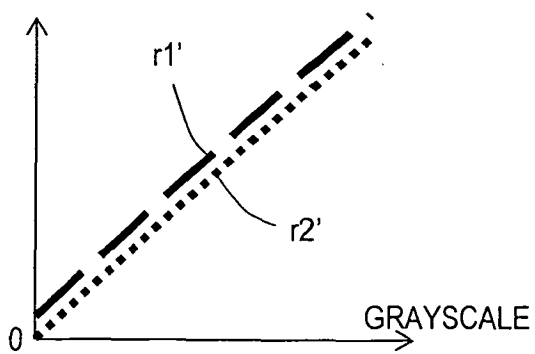

FIG. 14

(a)



(b)



(c)

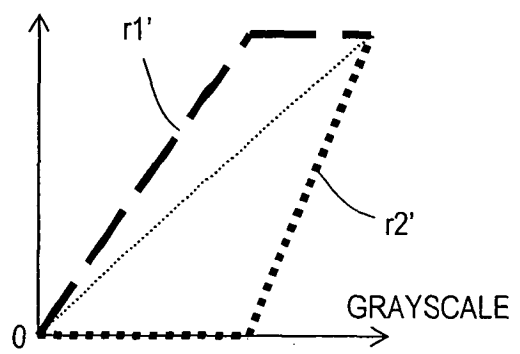

FIG. 15

(a)

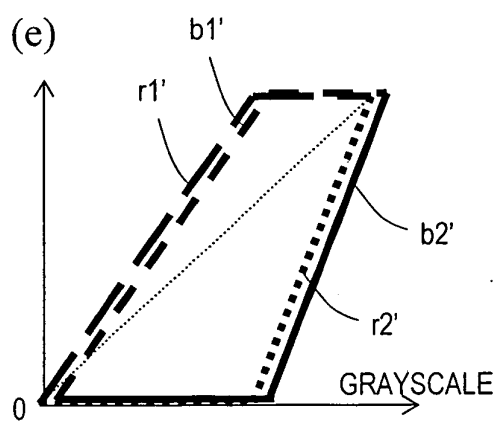
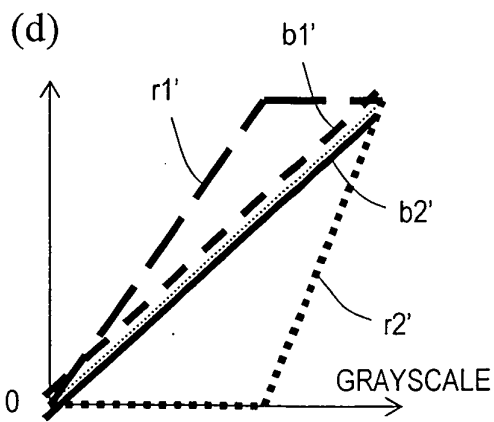
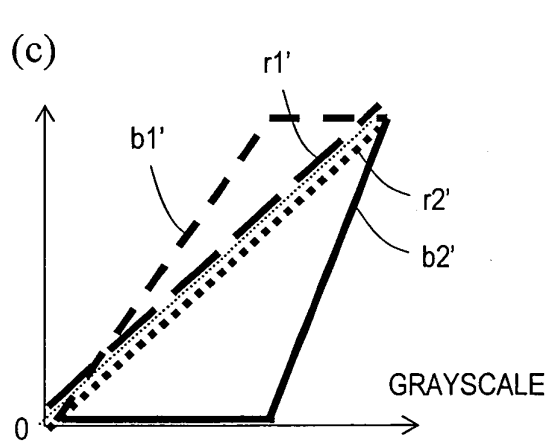
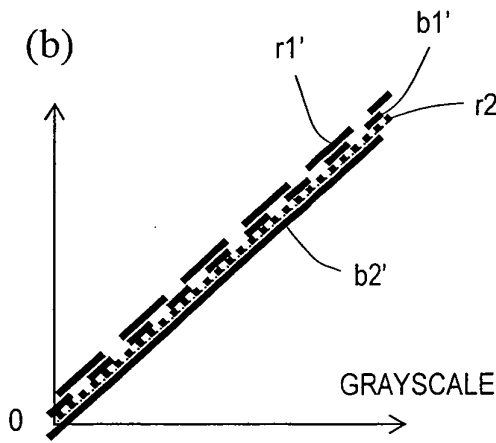
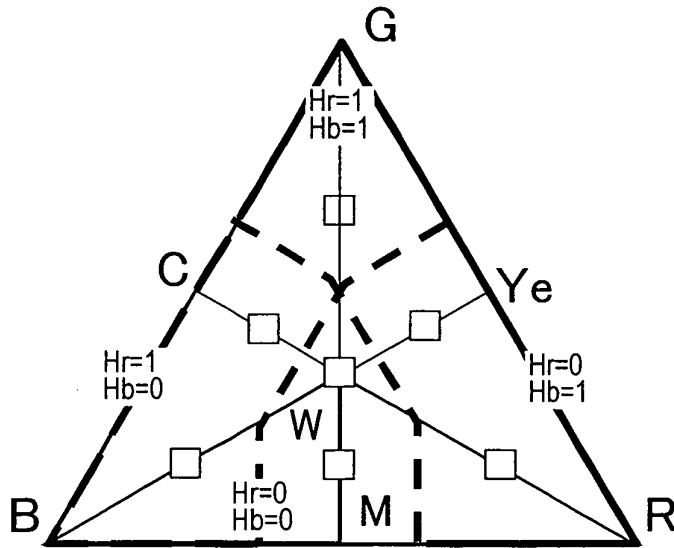

FIG.16

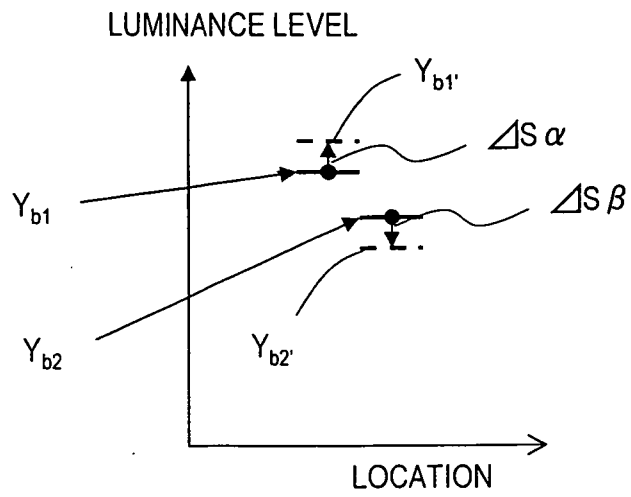

FIG. 17

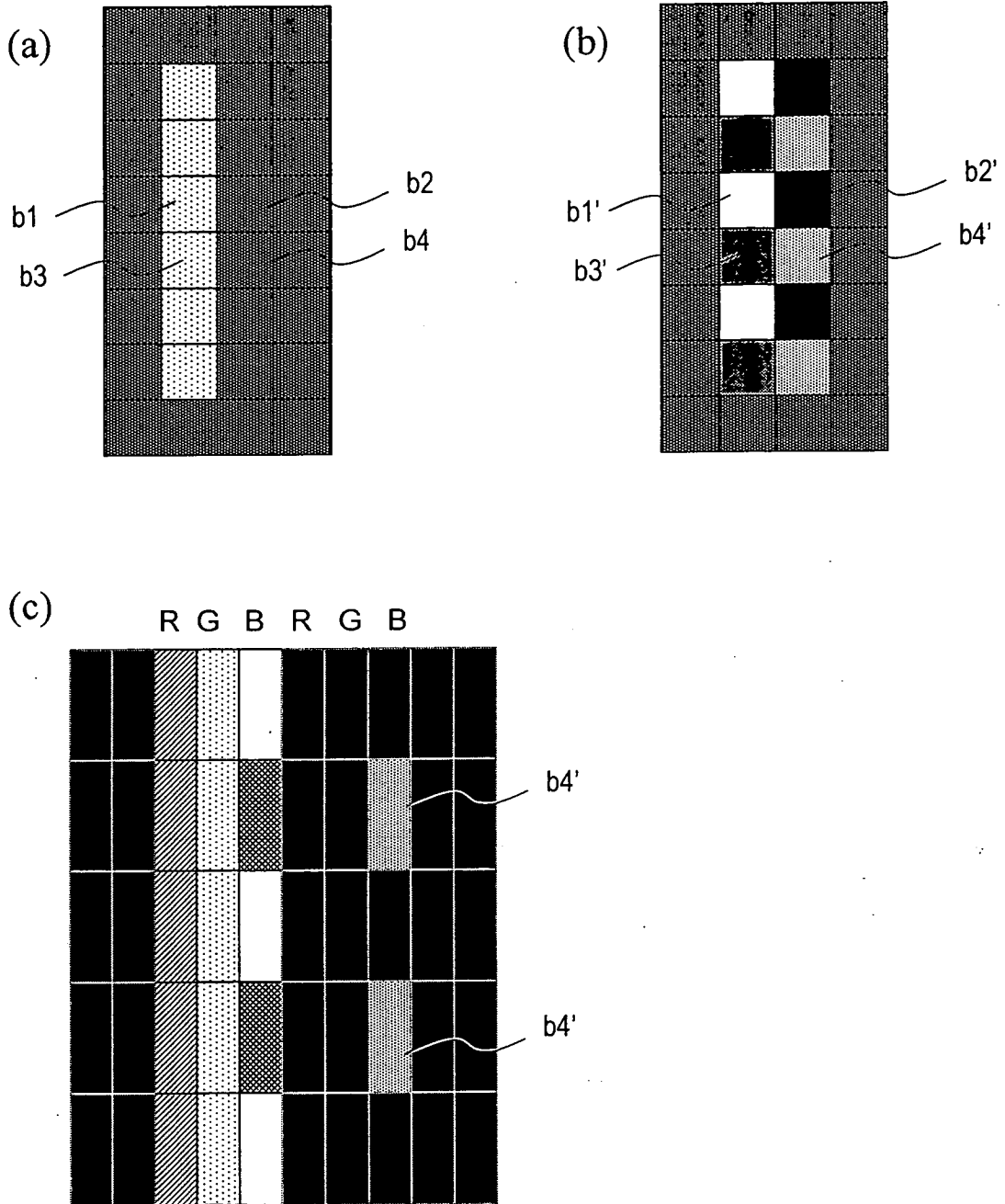

FIG. 18

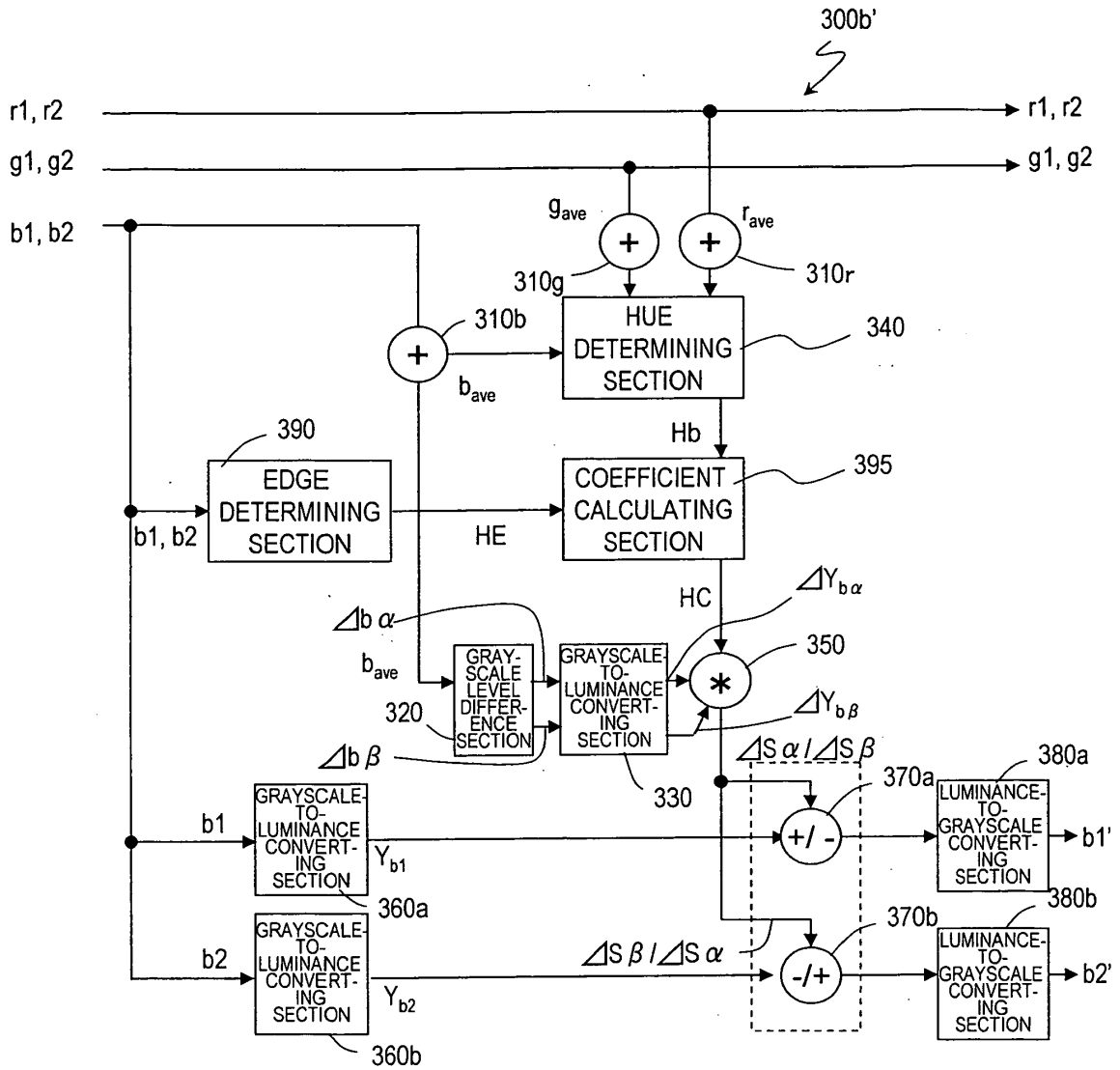
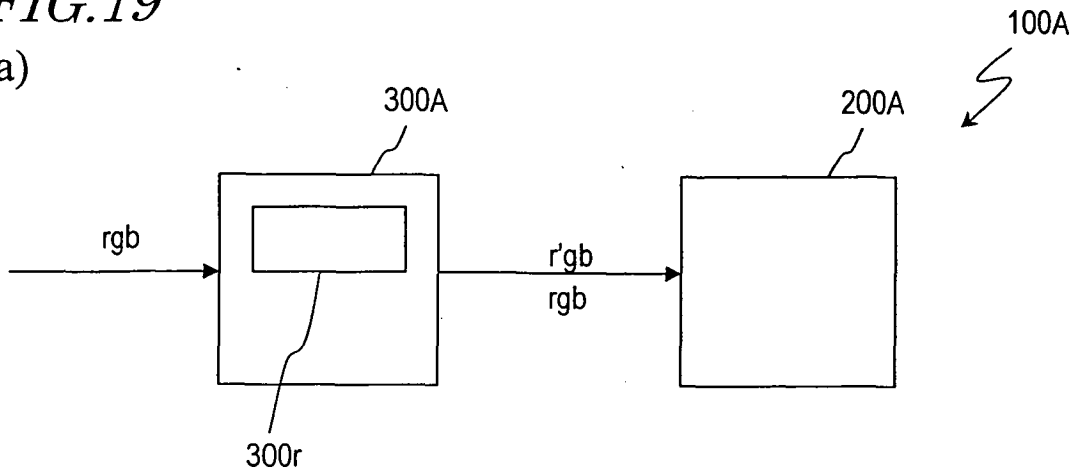
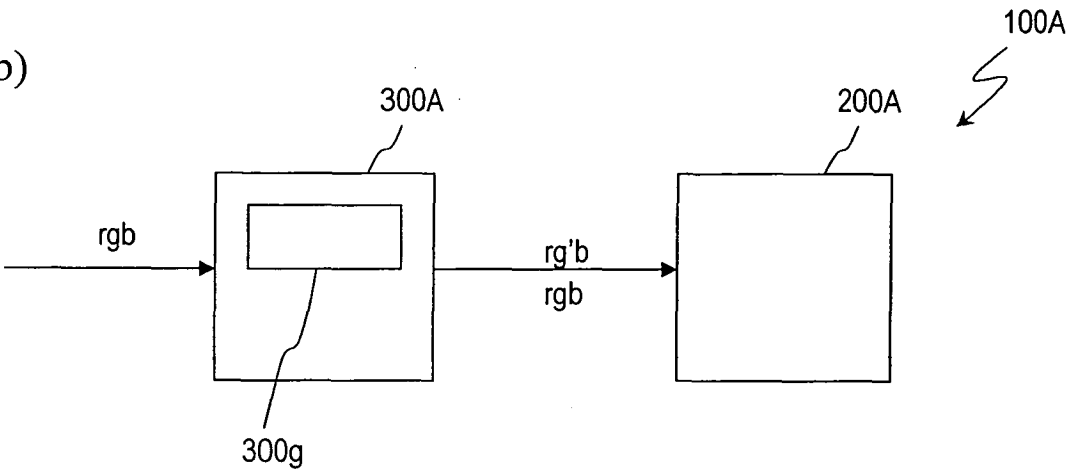

FIG. 19

(a)



(b)



(c)

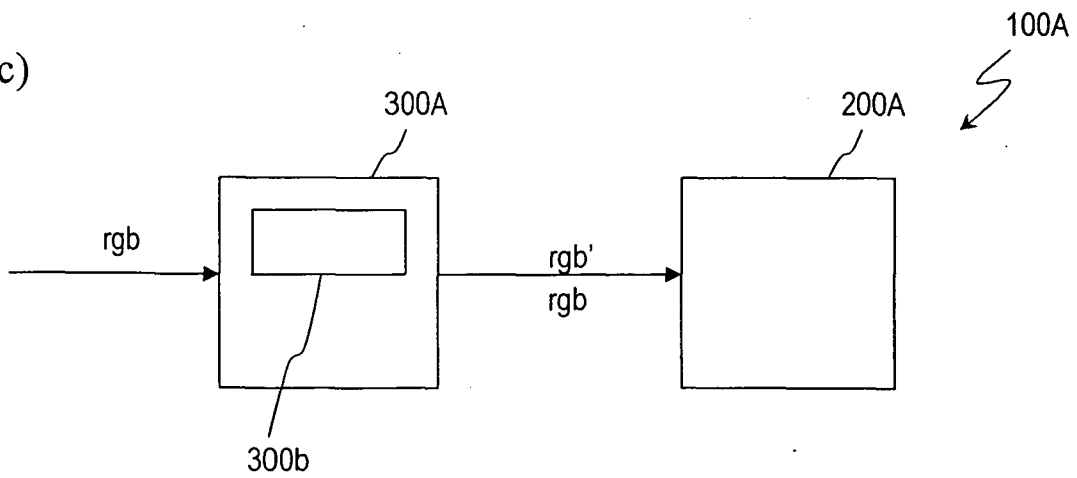

FIG. 20

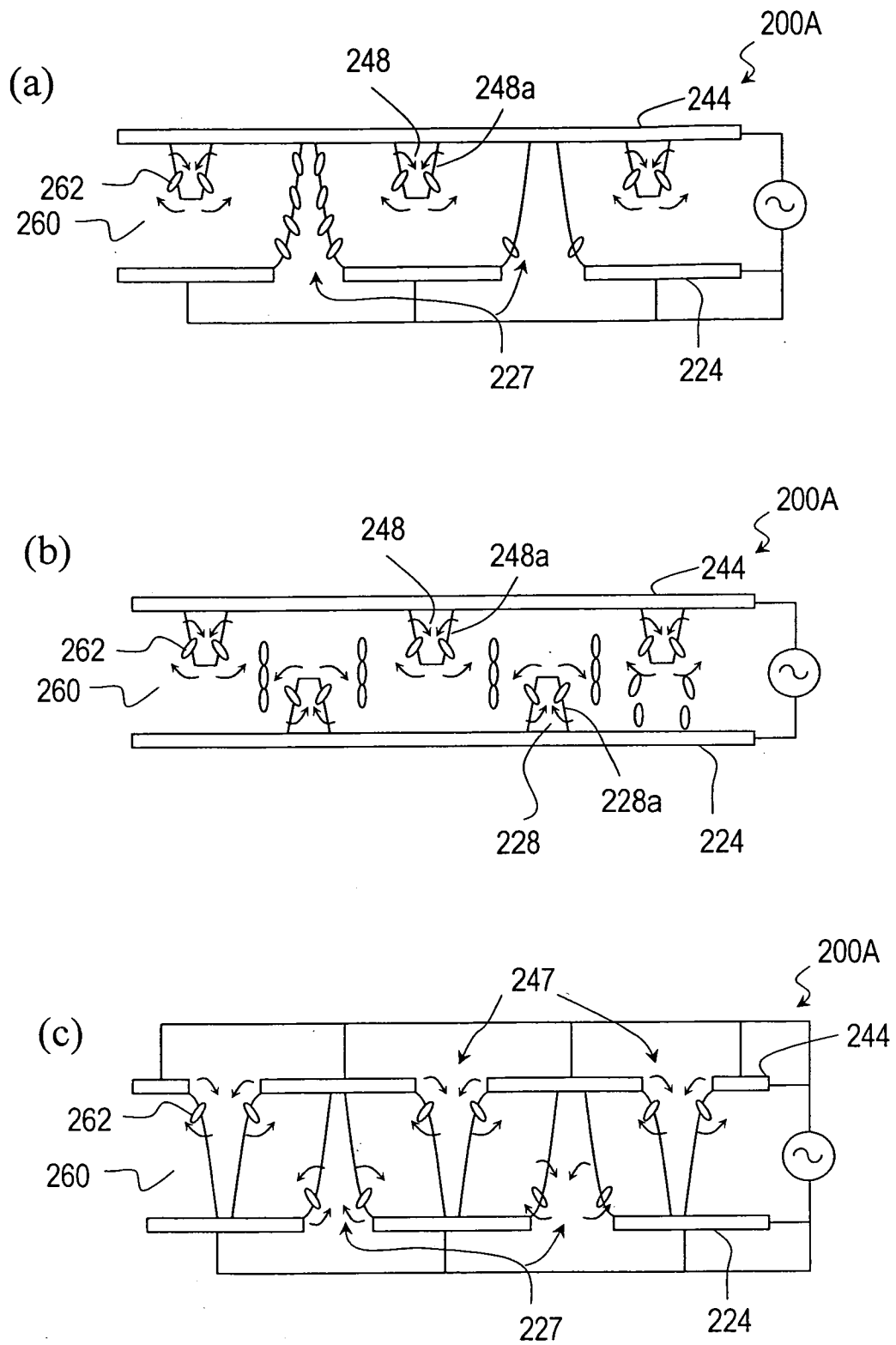

FIG. 21

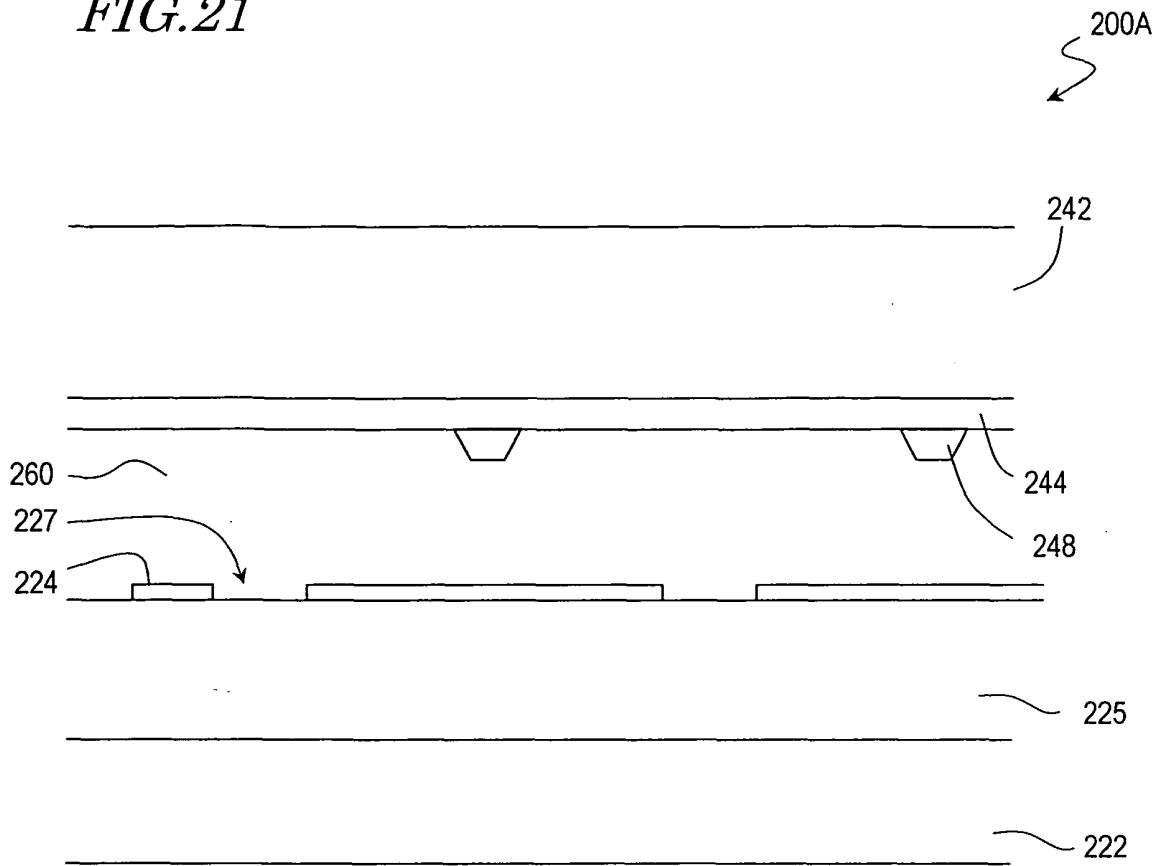

FIG. 22

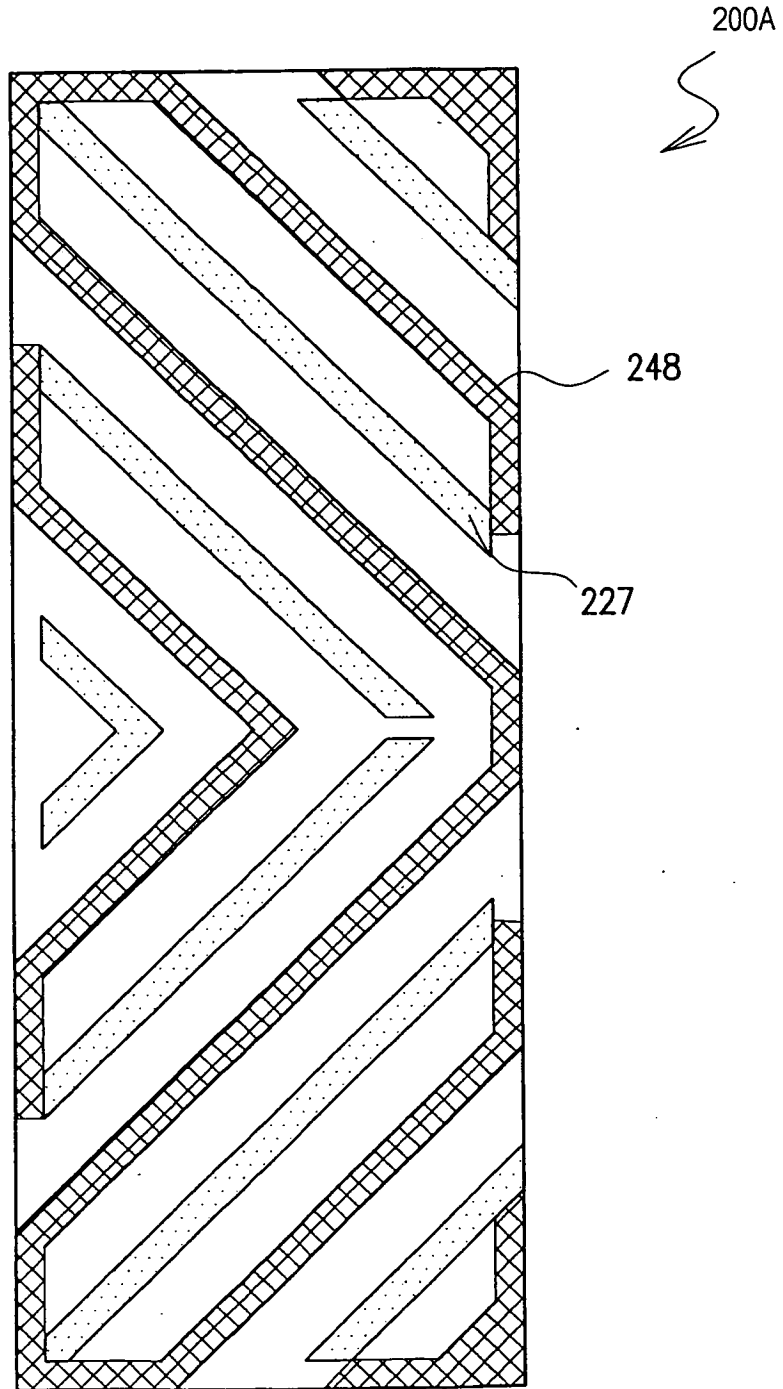

FIG. 23

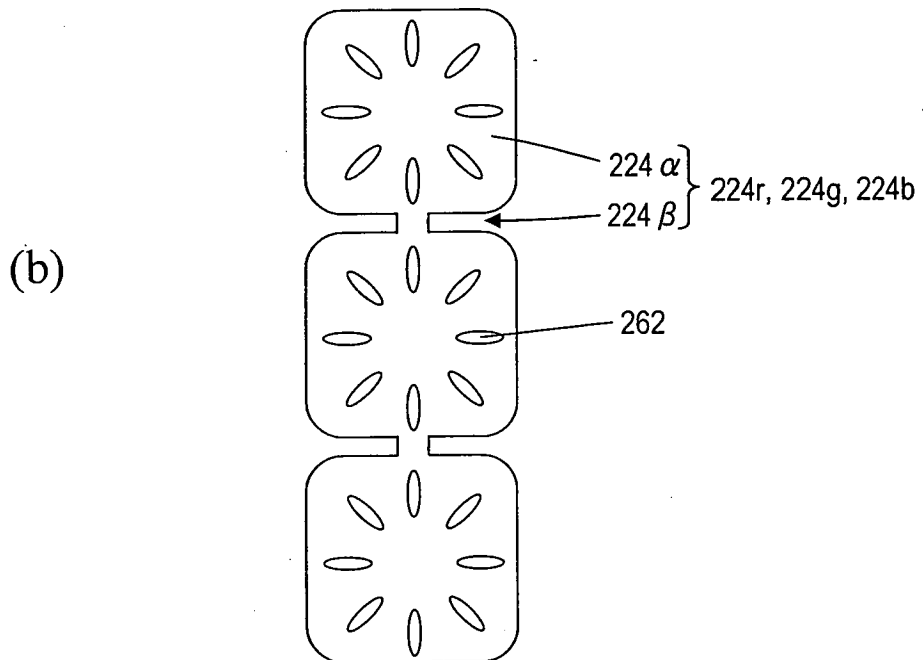
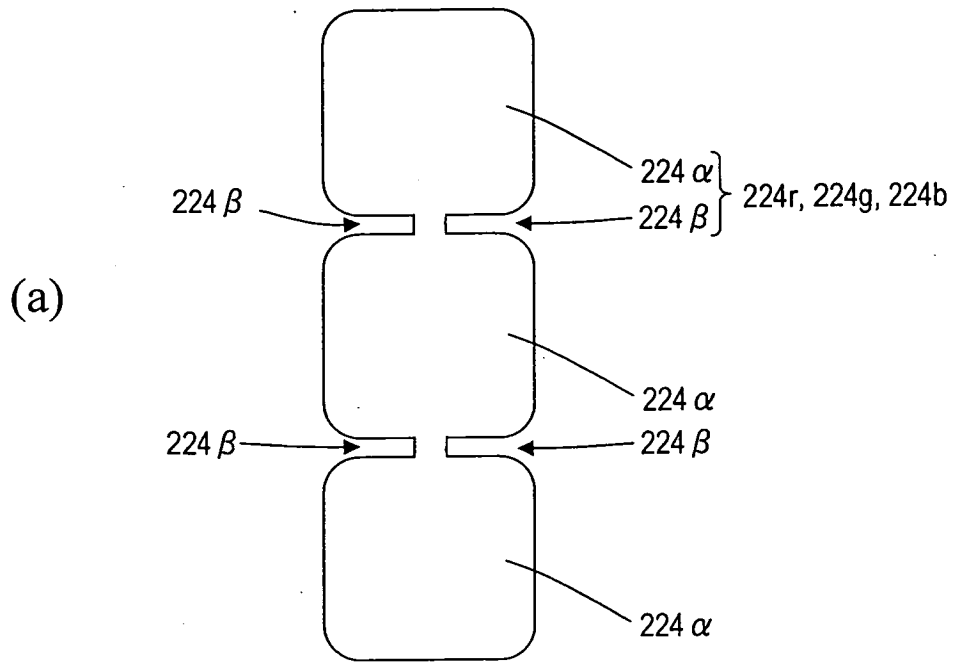

FIG. 24

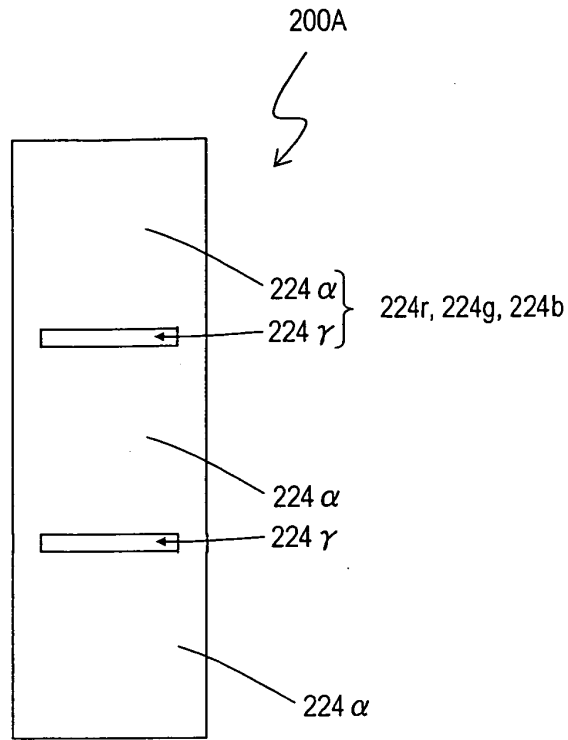

FIG. 25

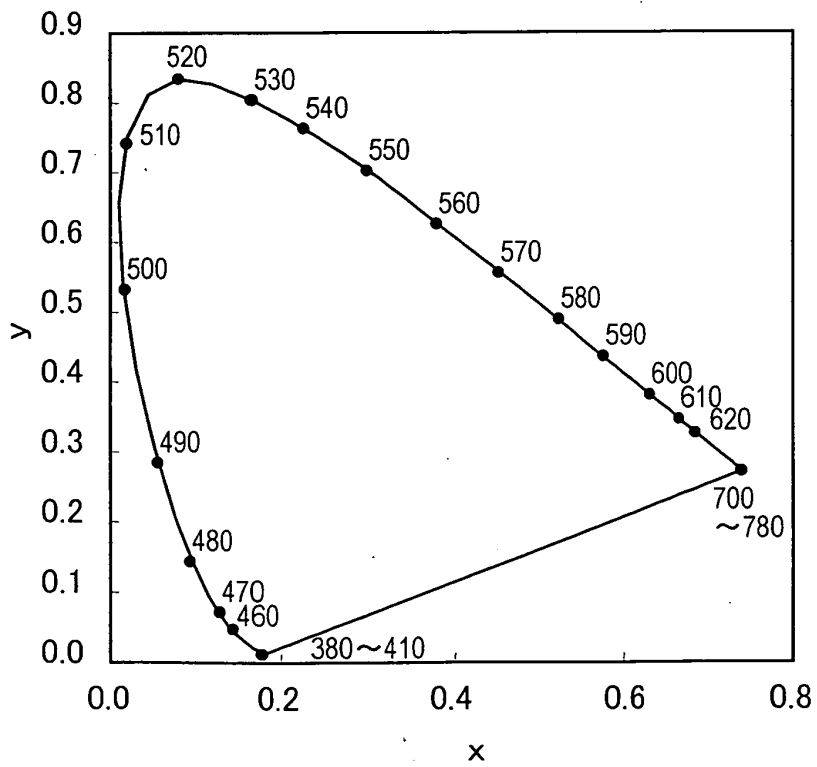

FIG. 26

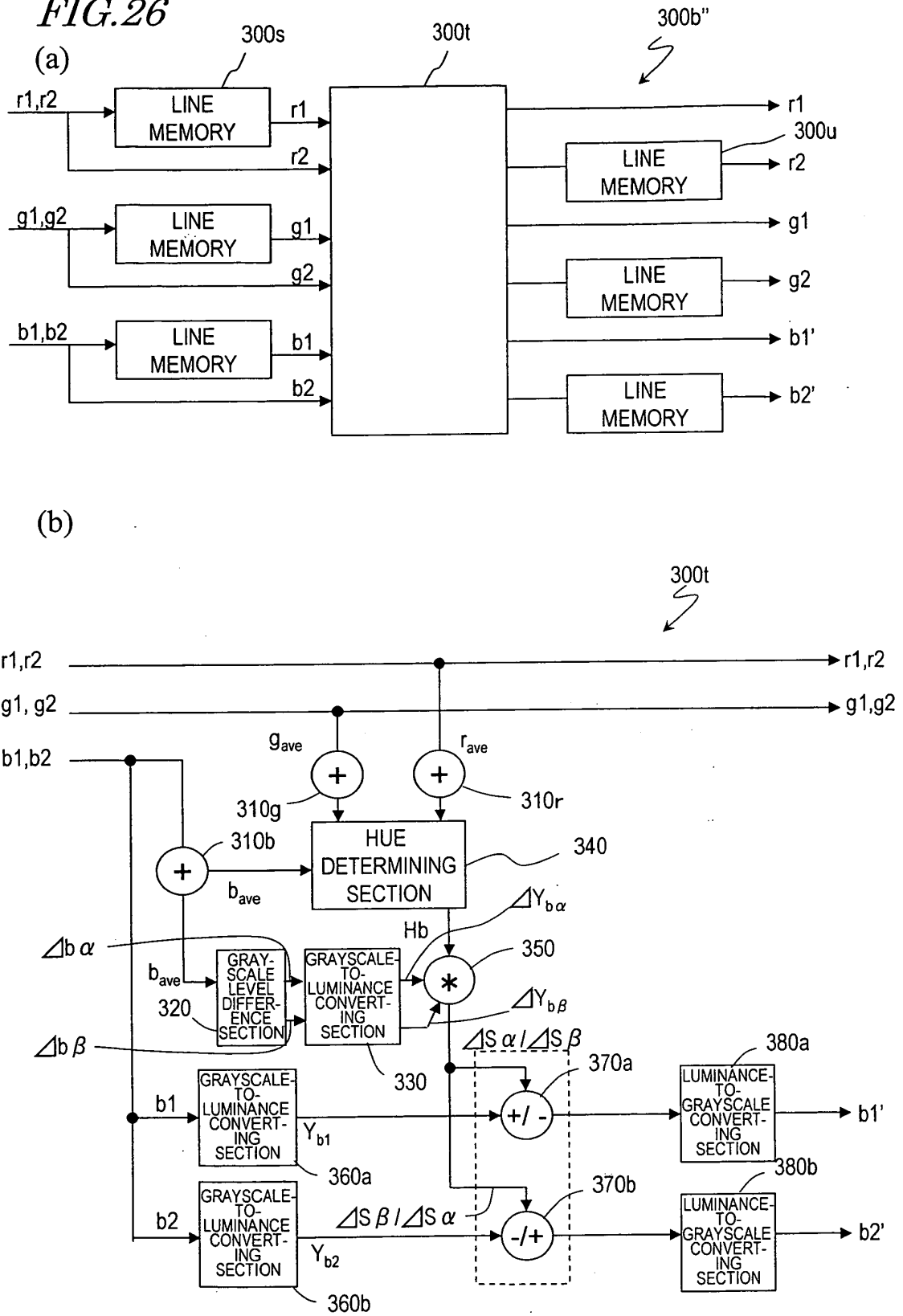

FIG. 27

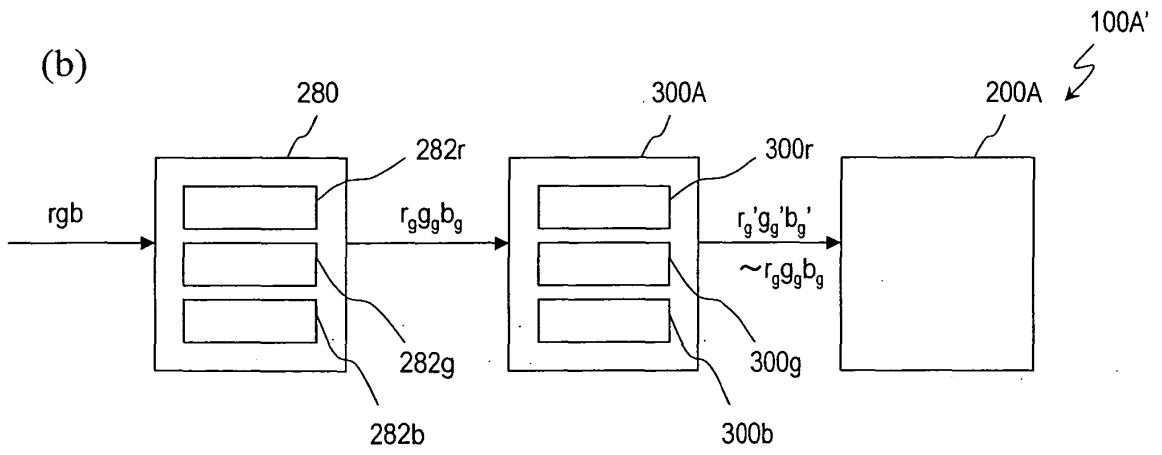
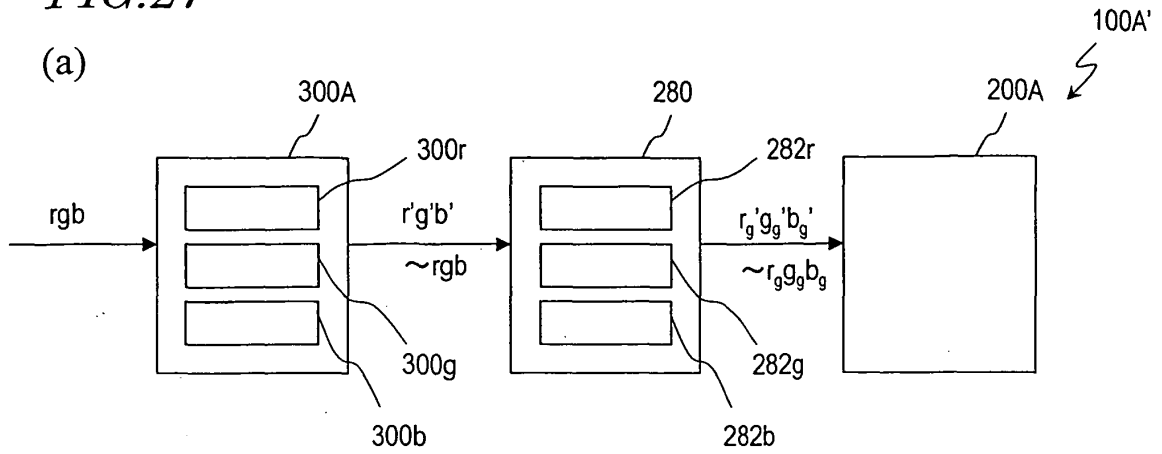

FIG. 28

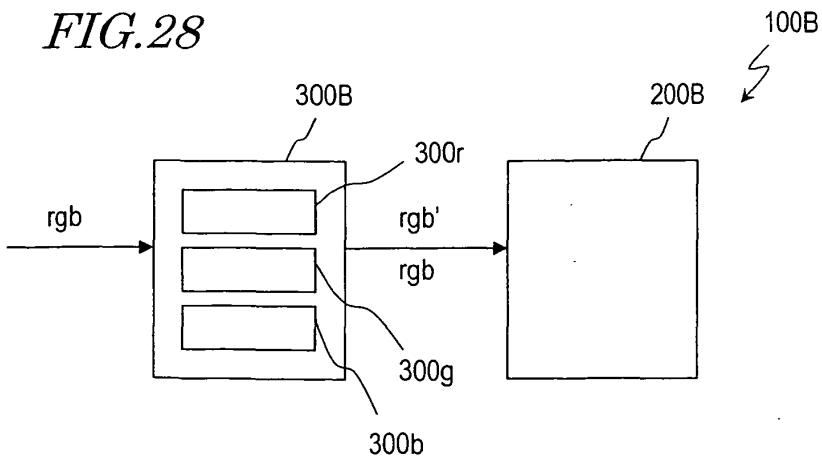

FIG. 29

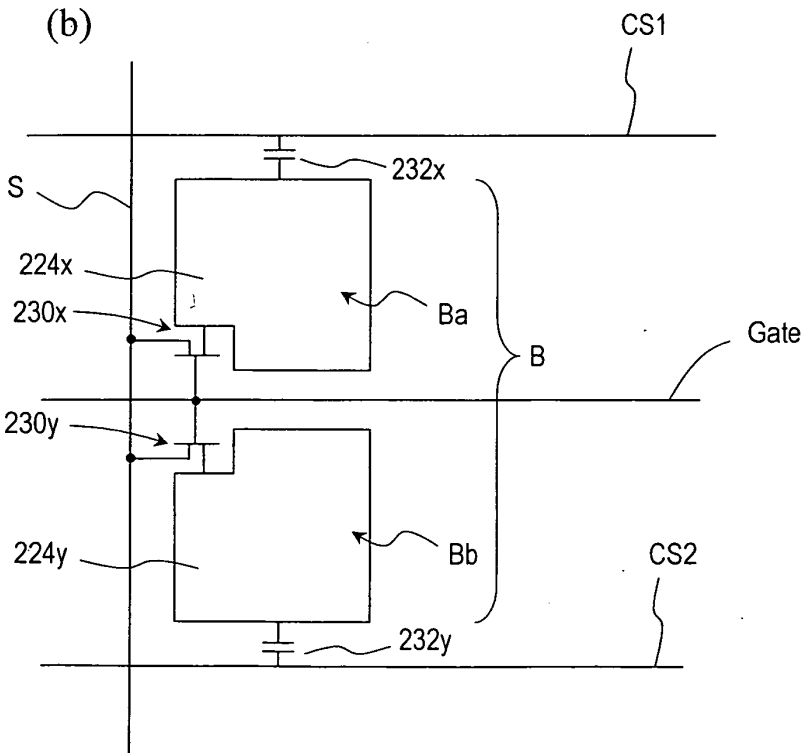
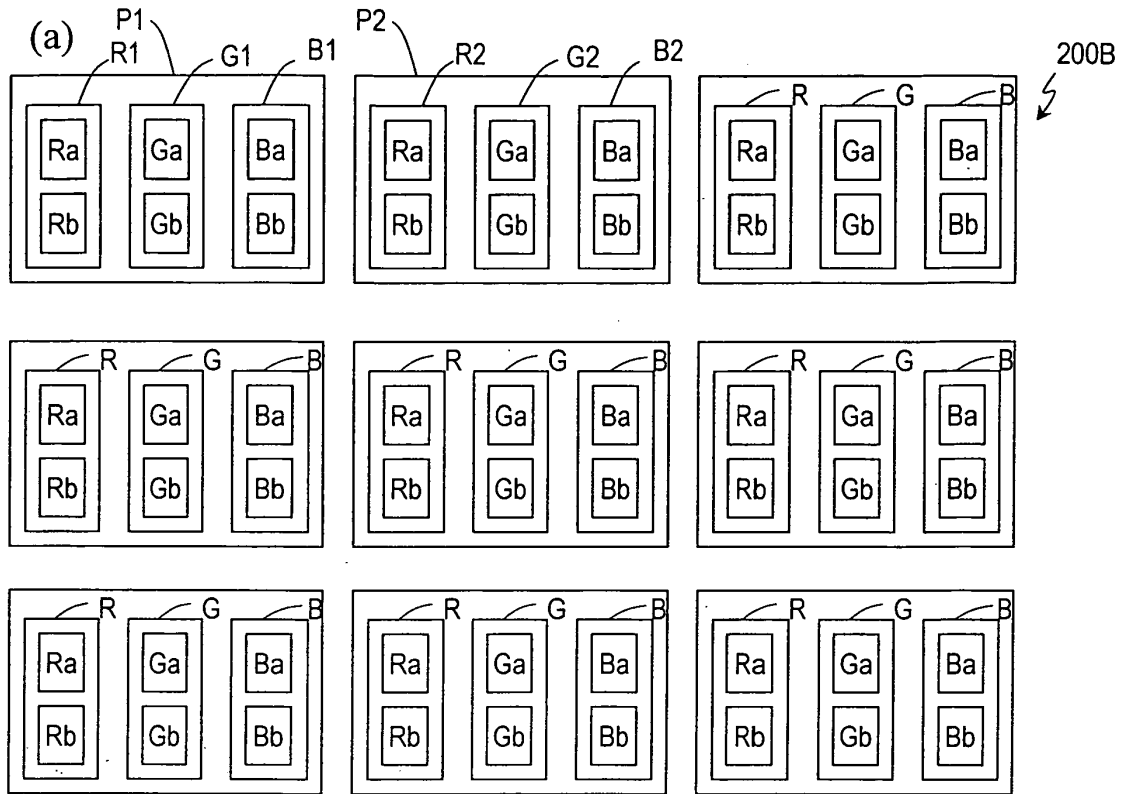

FIG. 30

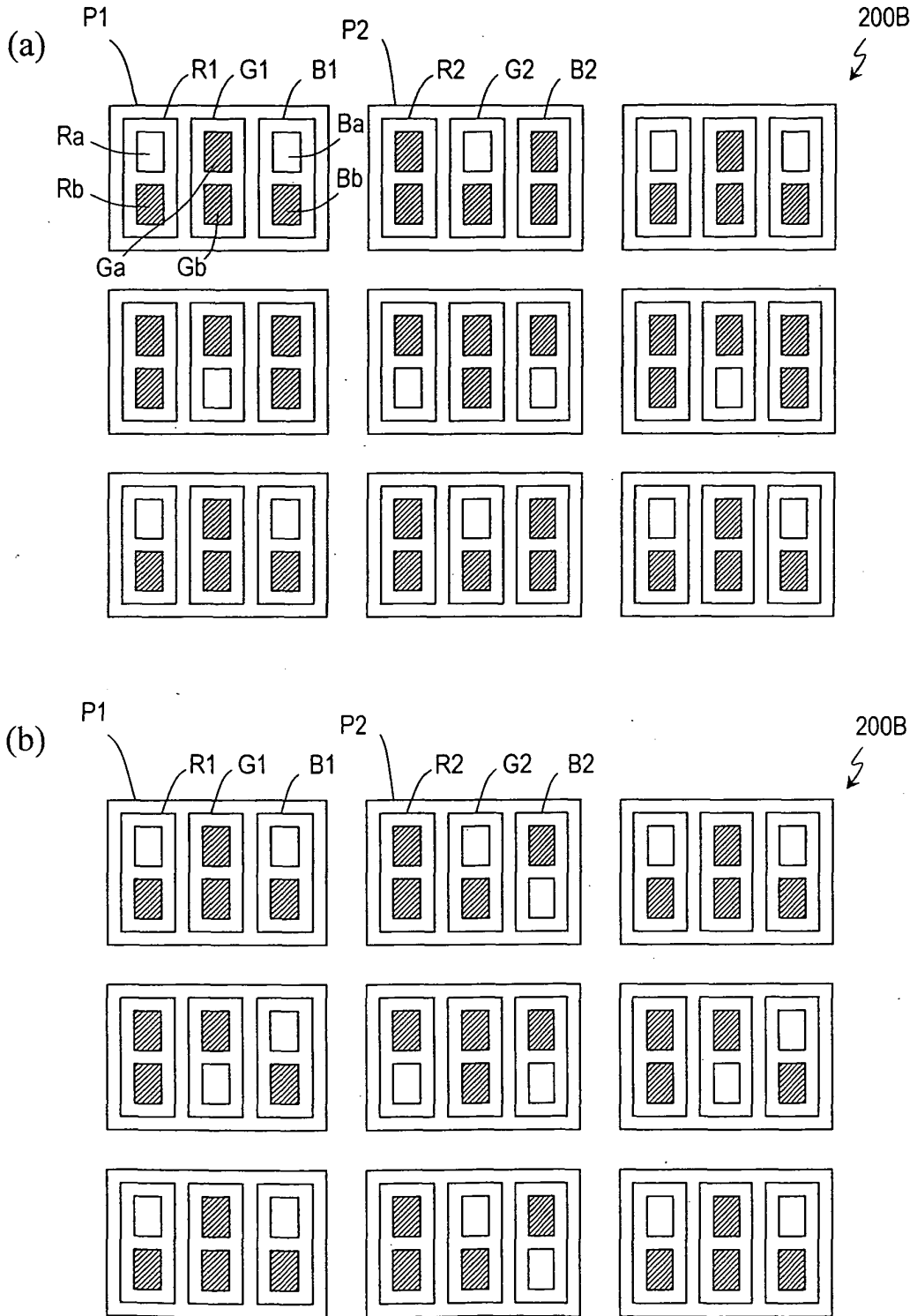

FIG. 31

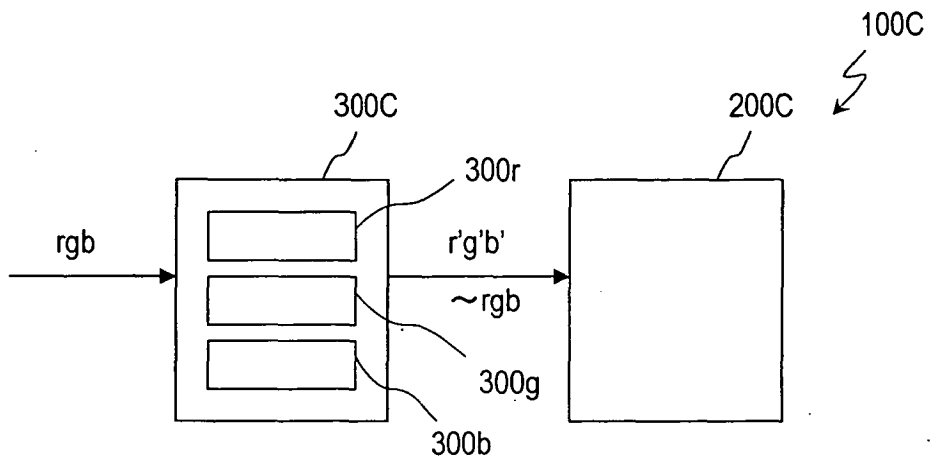

FIG. 32

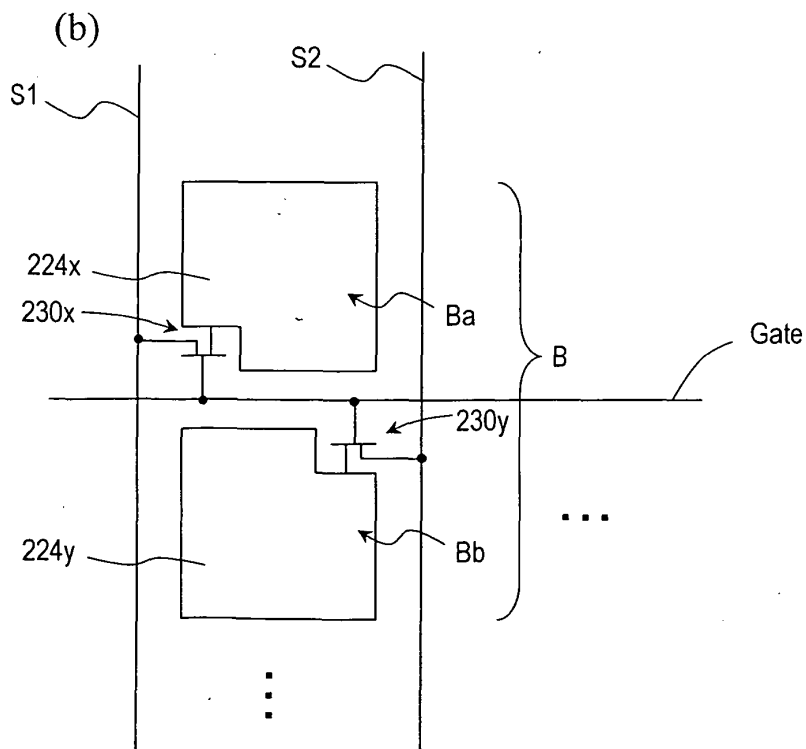
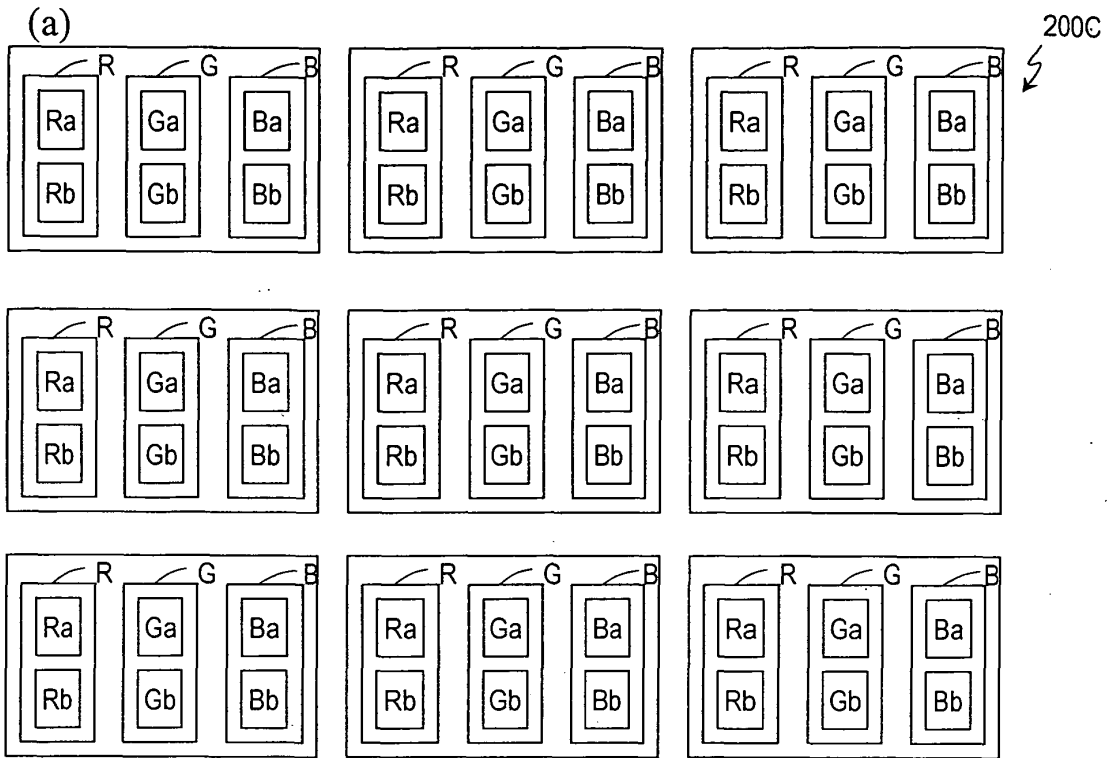
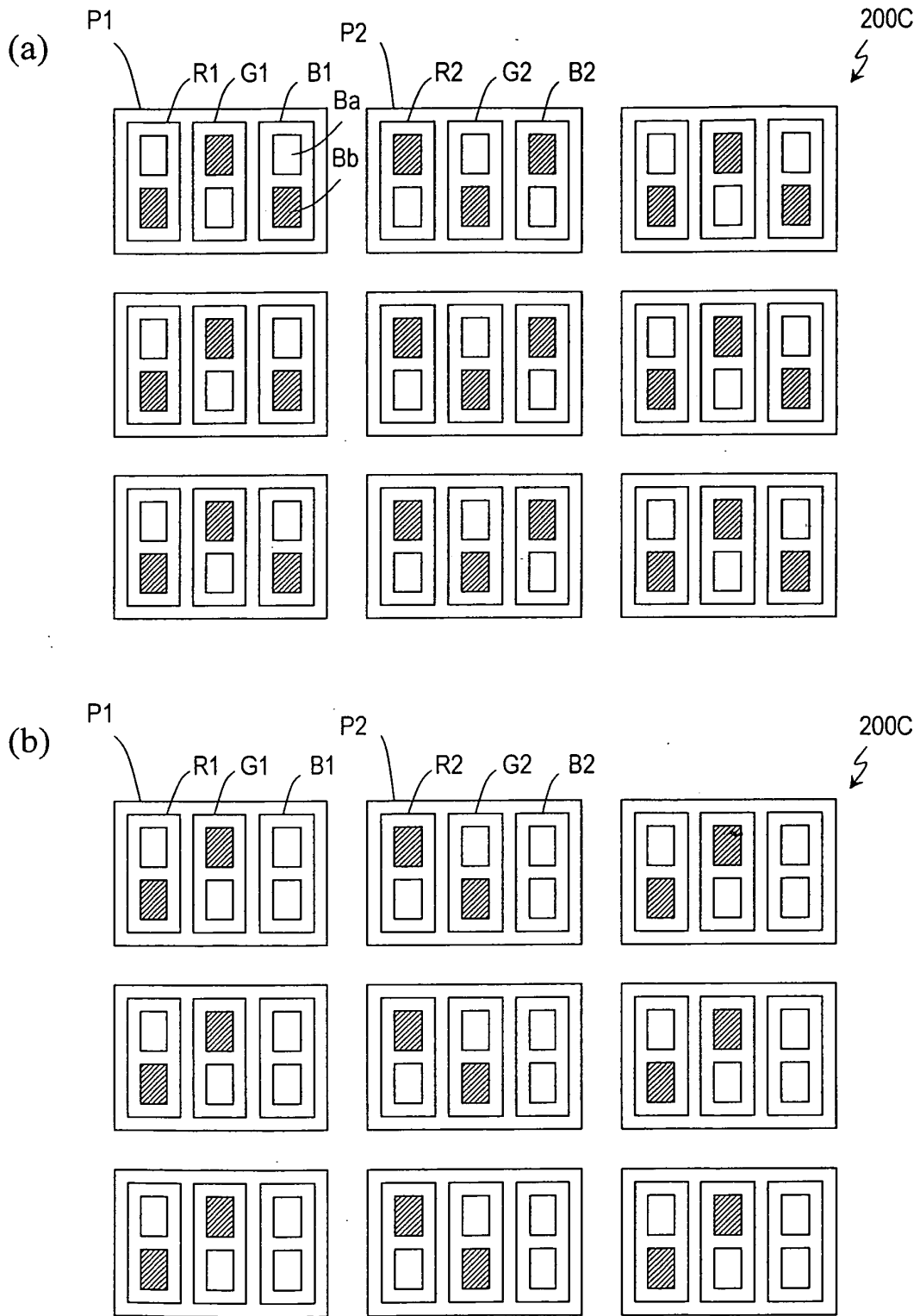

FIG. 33



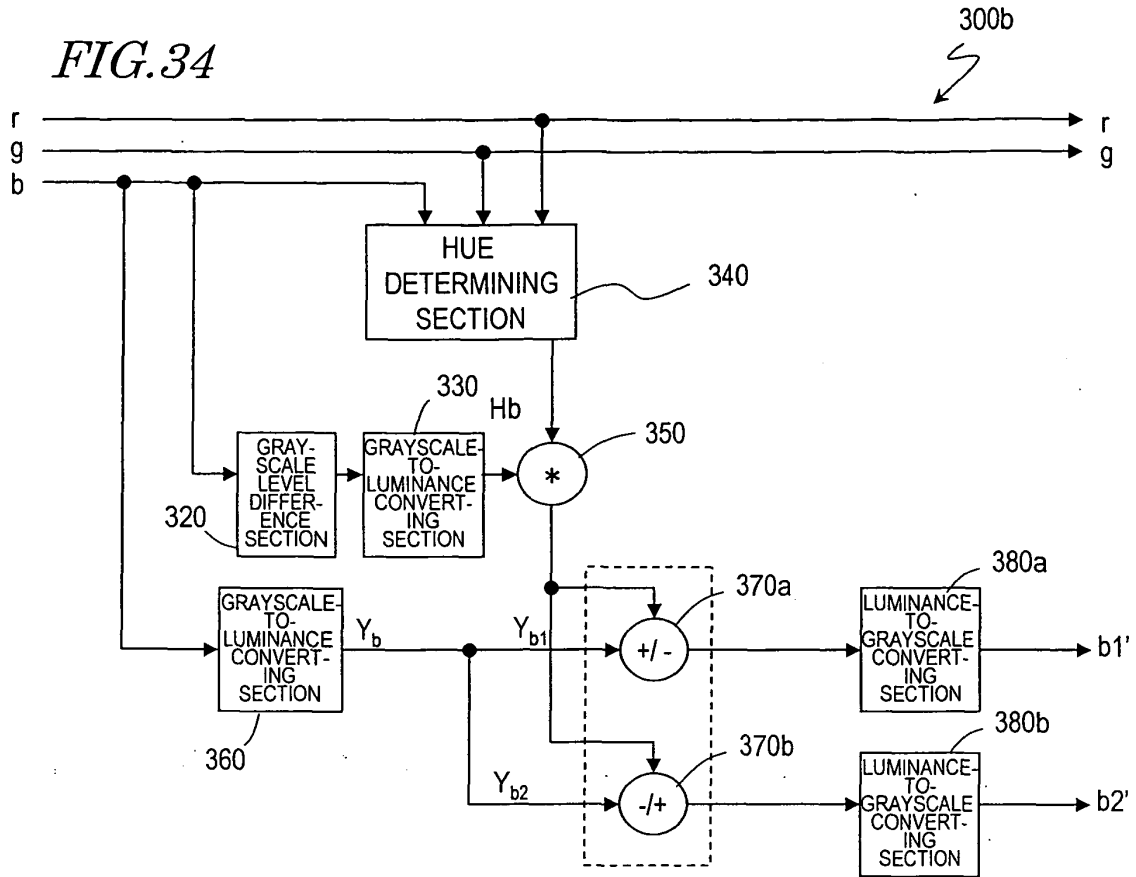

FIG. 35

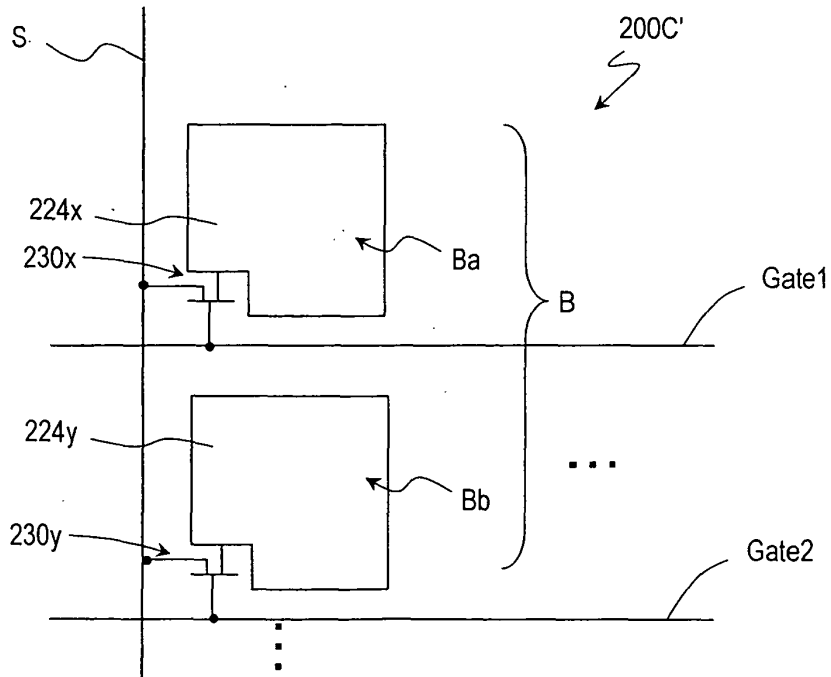

FIG. 36

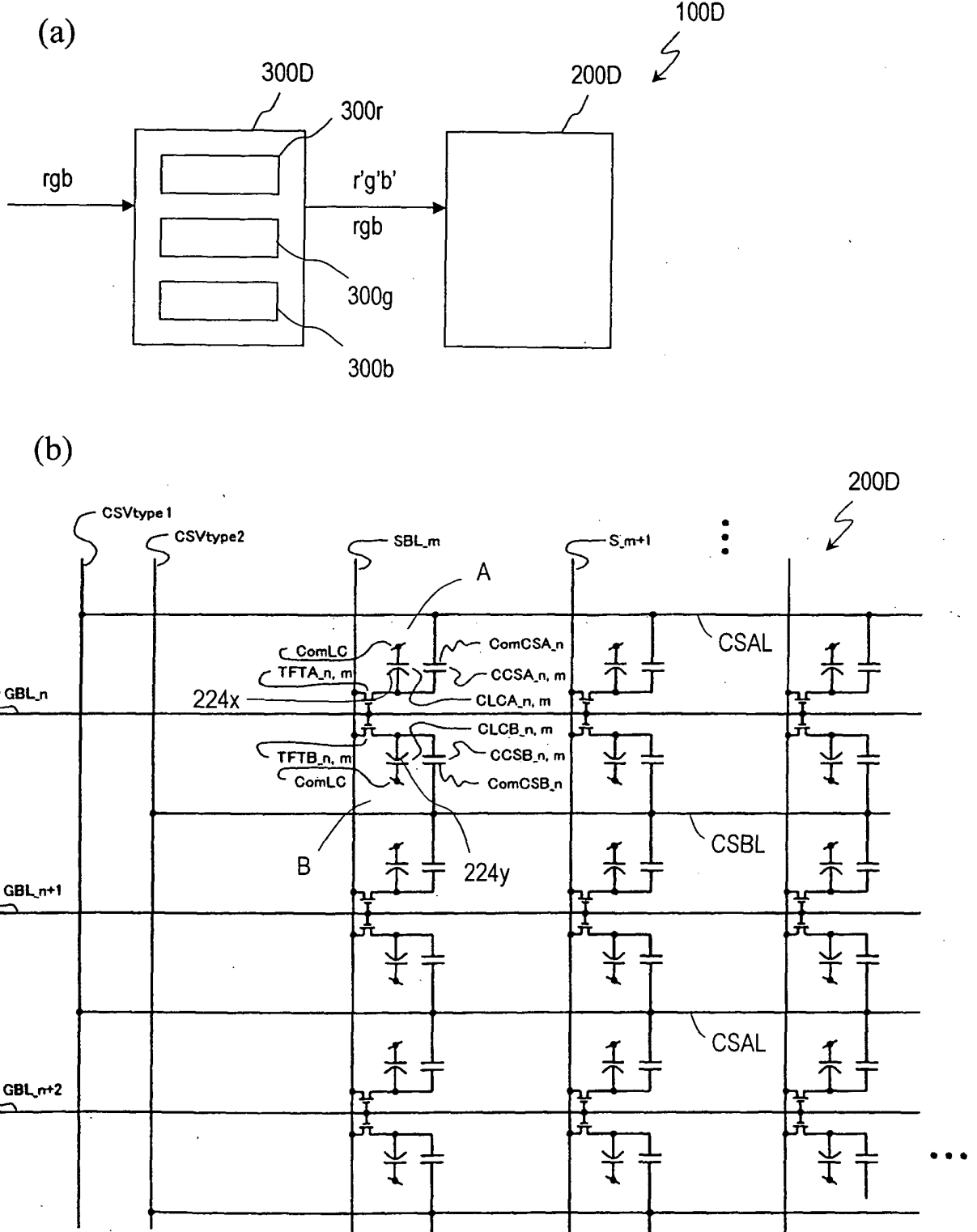

FIG.37

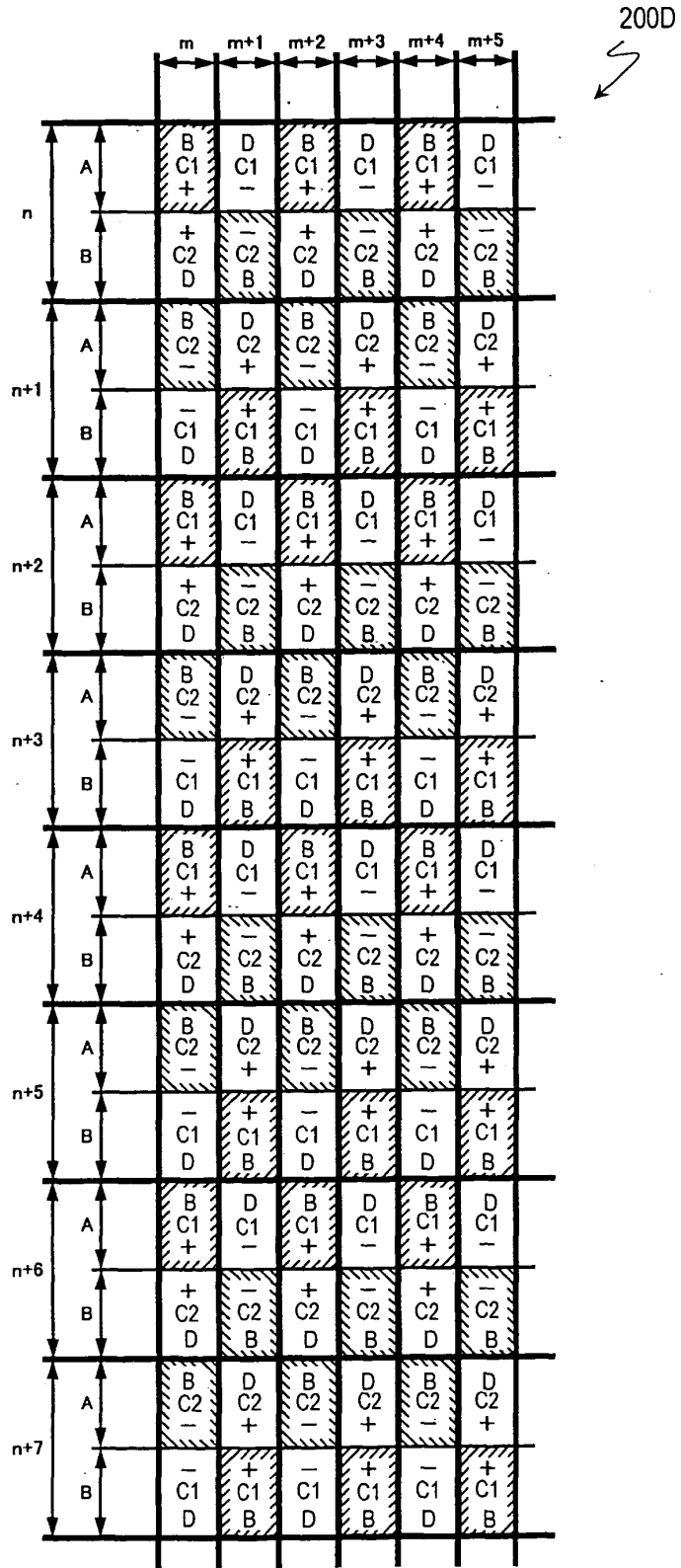

FIG.38

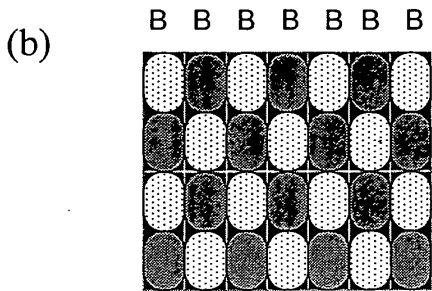
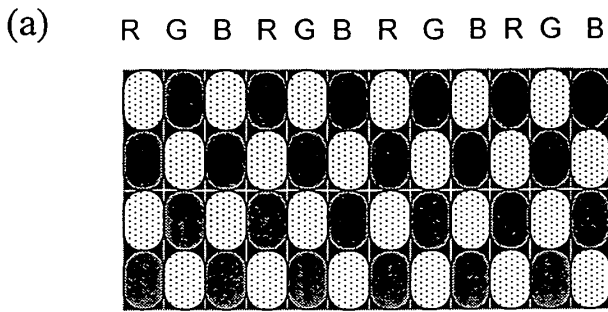

FIG.39

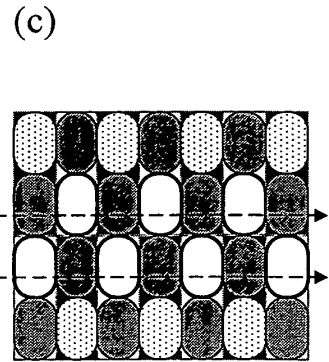
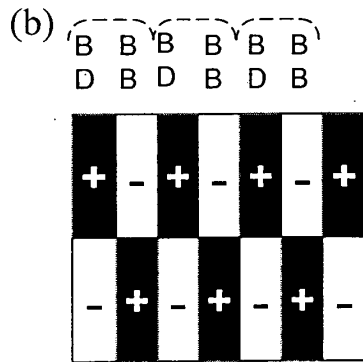
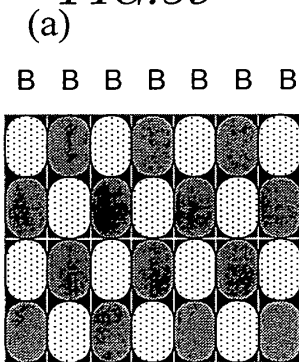

FIG.40

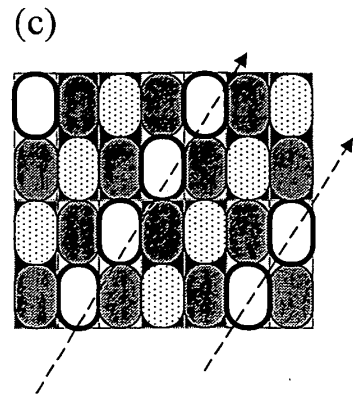
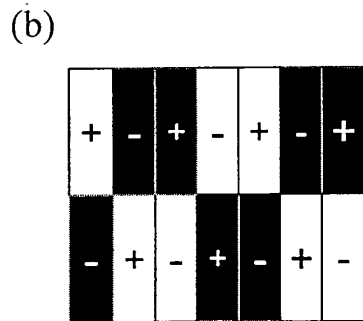
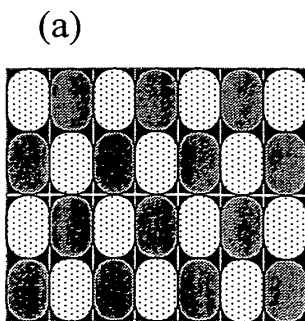
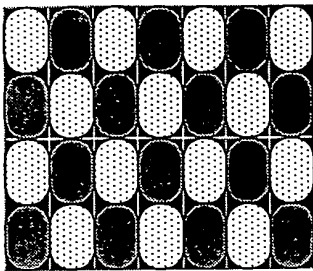
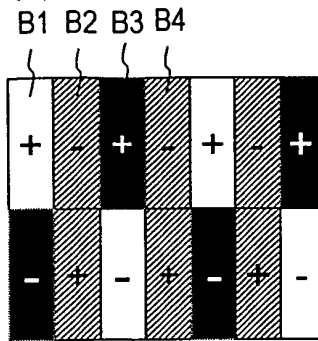

FIG. 41

(a)



(b)



(c)

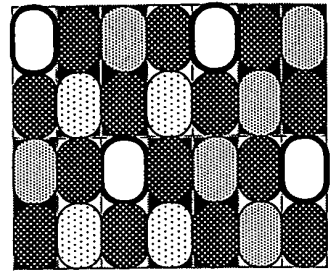

FIG. 42

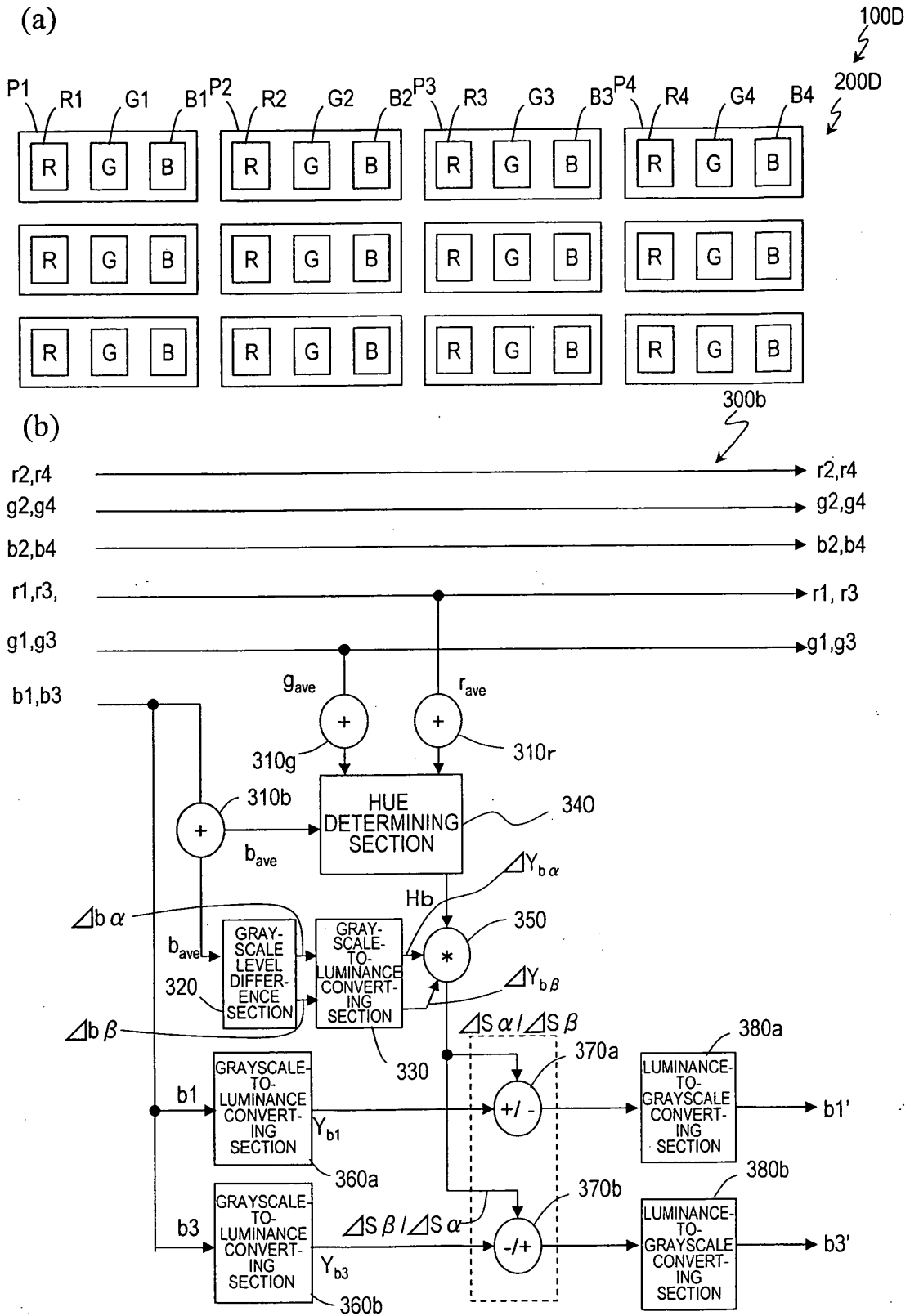

FIG.43

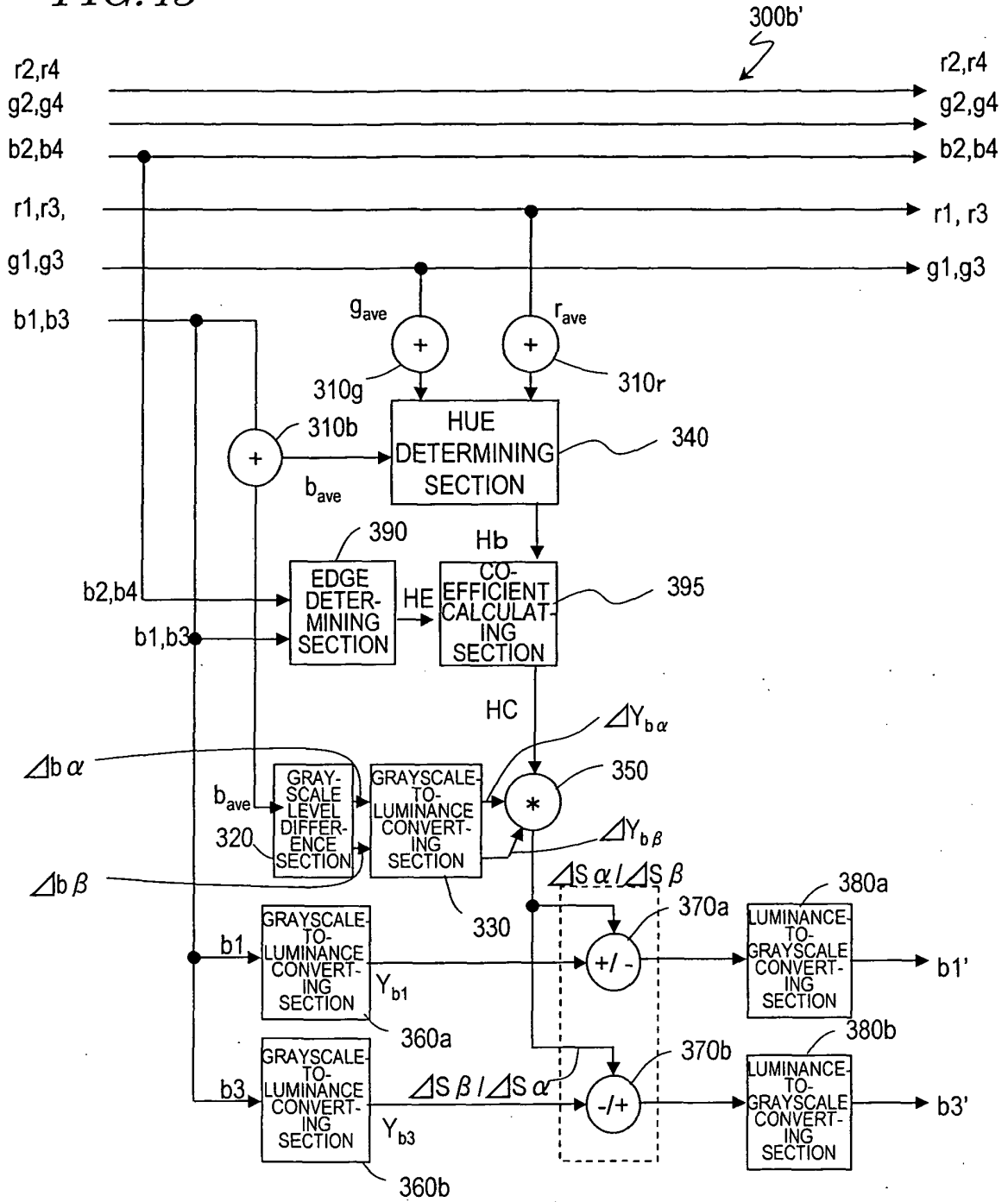

FIG. 44

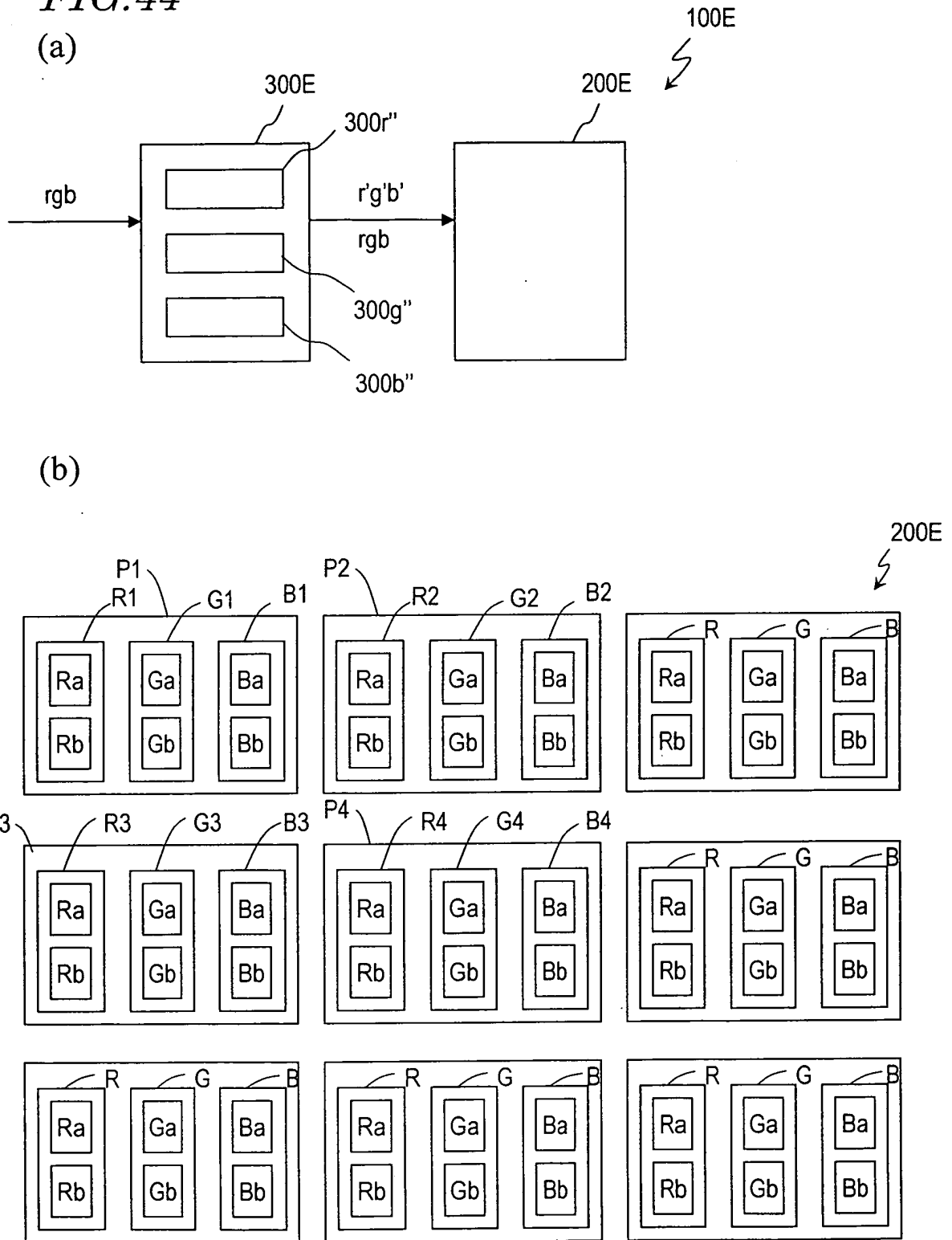

FIG. 45

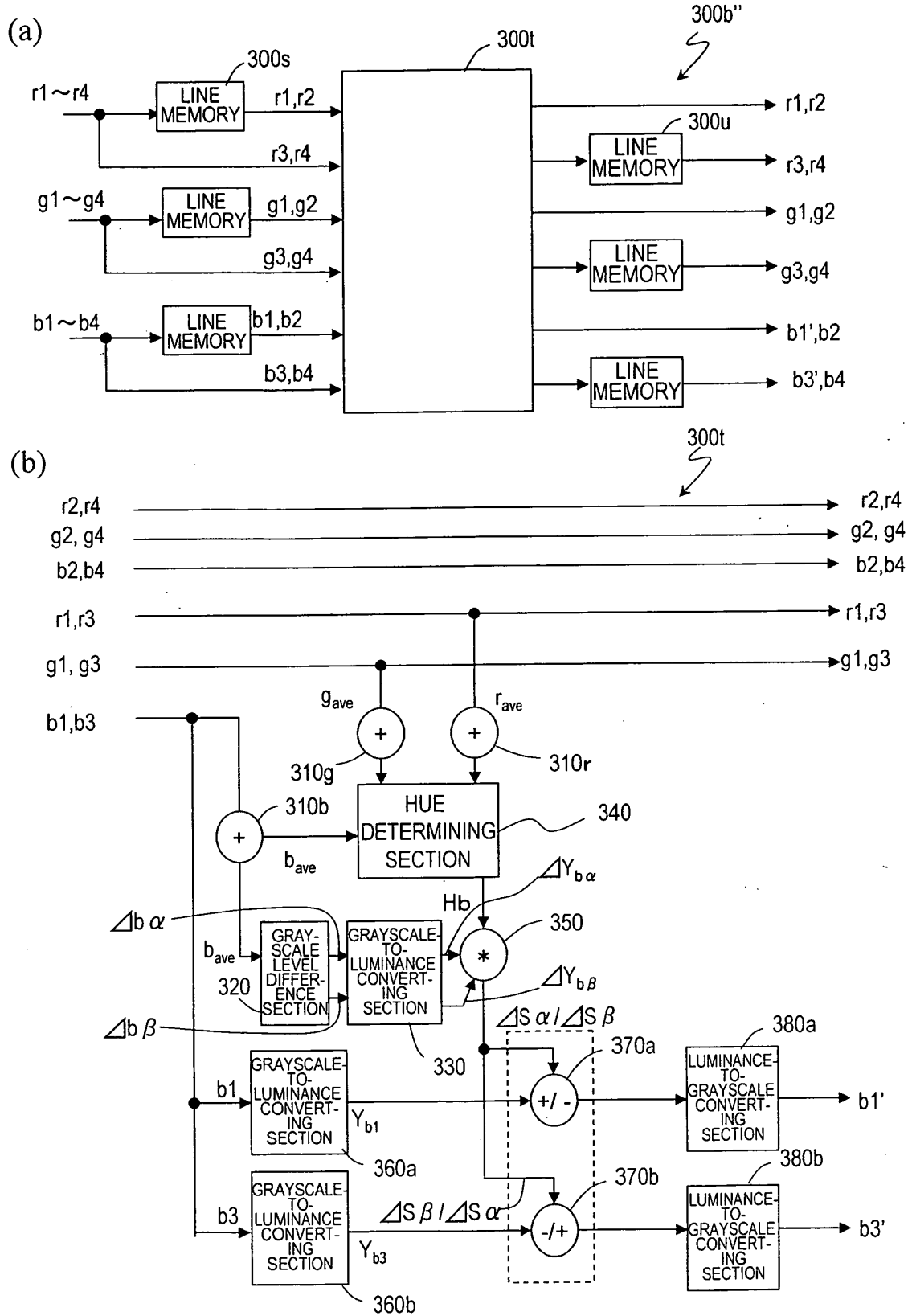

FIG. 46

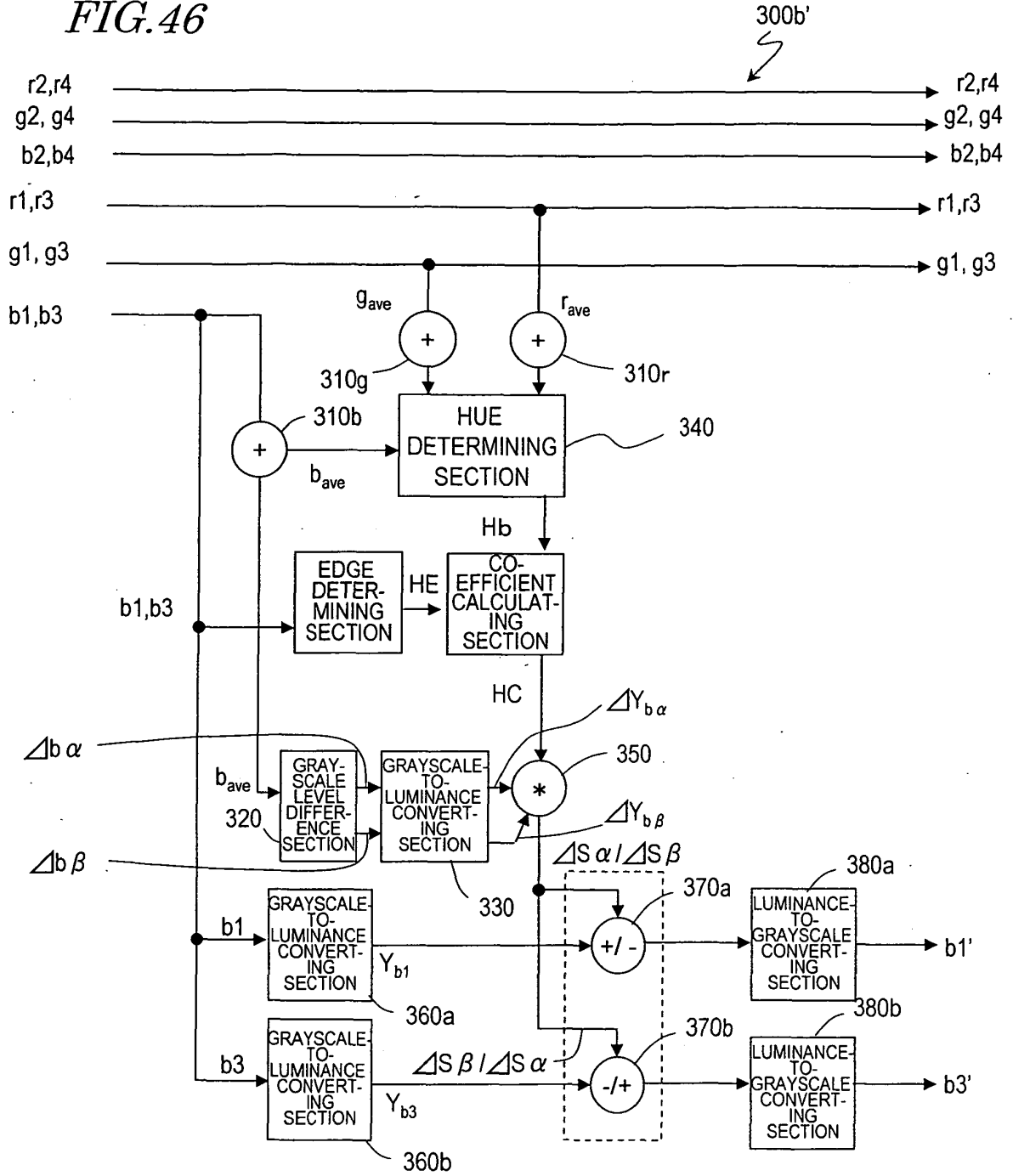

FIG. 47

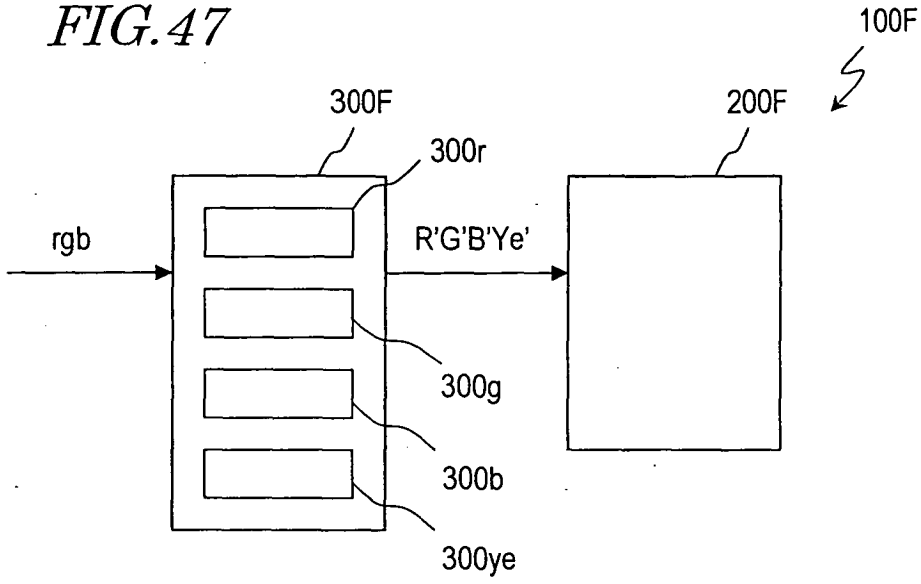

FIG. 48

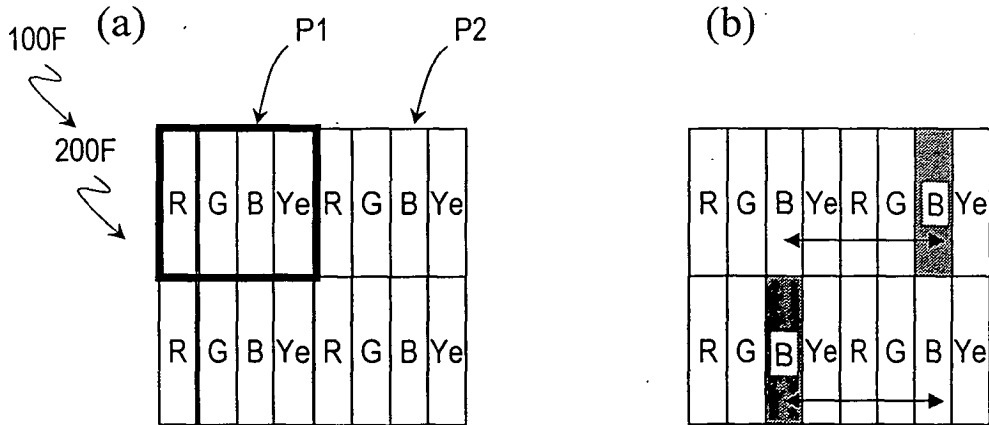

FIG. 49

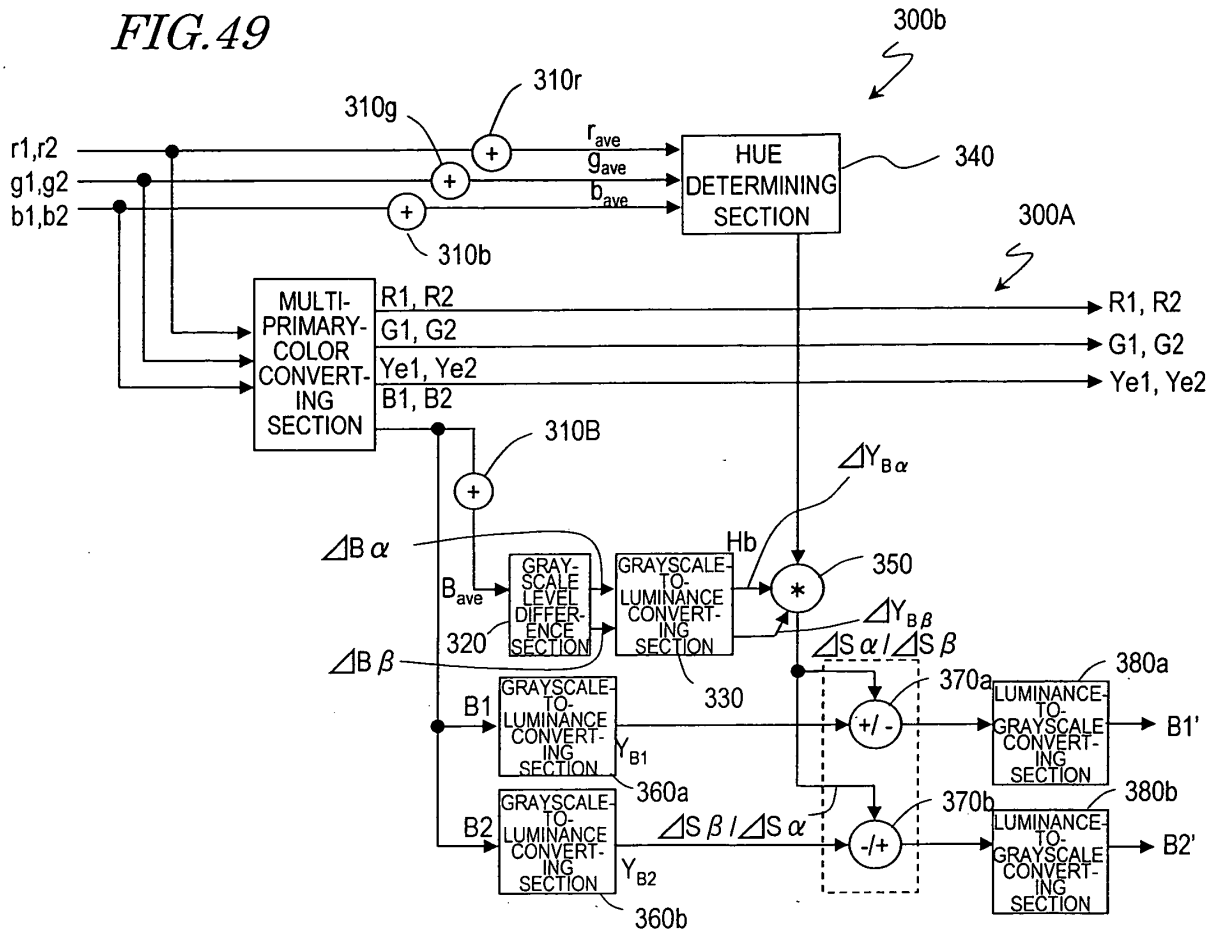

FIG. 50

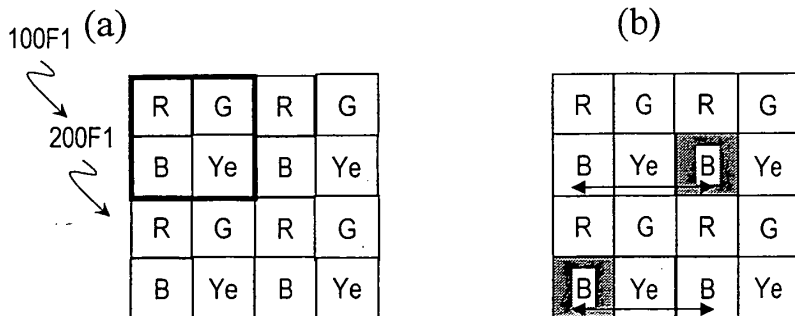

FIG. 51

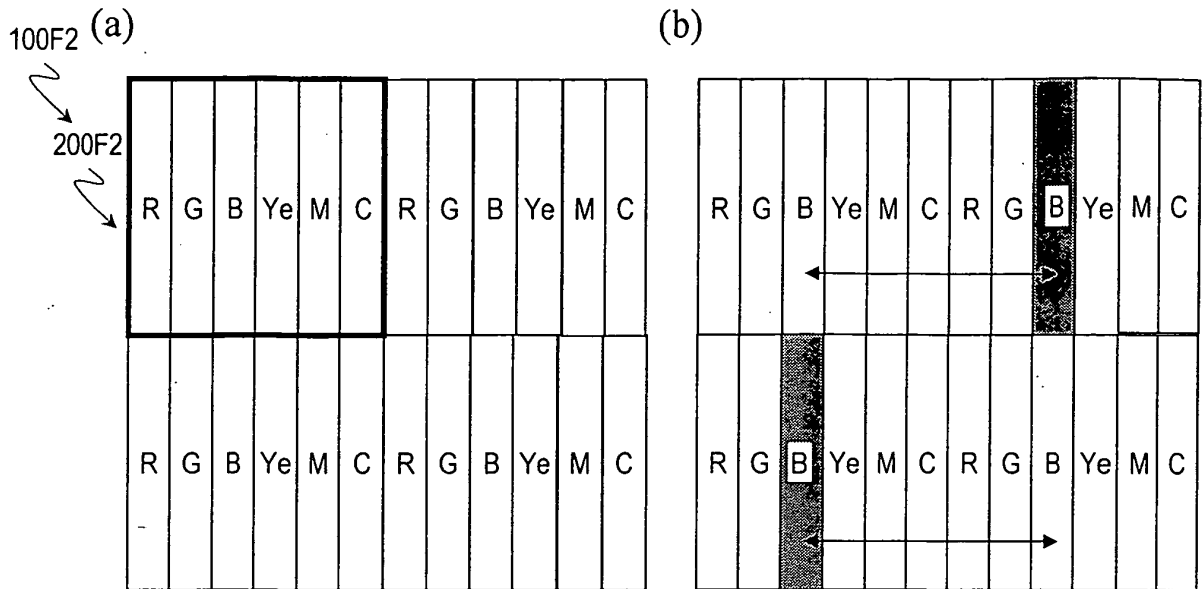
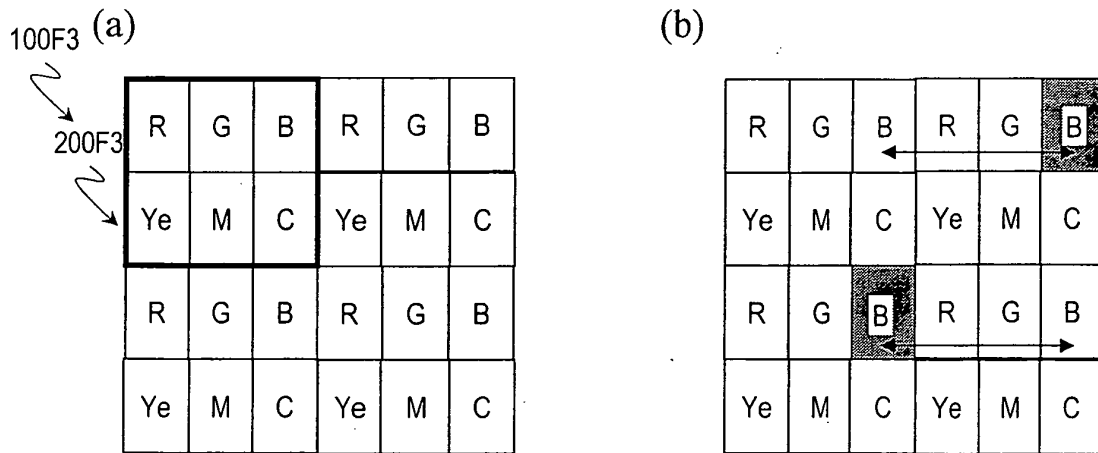

FIG. 52



INTERNATIONAL SEARCH REPORT

International application No.

PCT/JP2009/007233

A. CLASSIFICATION OF SUBJECT MATTER <i>G09G3/36(2006.01)i, G02F1/133(2006.01)i, G02F1/1343(2006.01)i, G09G3/20(2006.01)i, G09G5/02(2006.01)i, H04N9/30(2006.01)i</i>		
According to International Patent Classification (IPC) or to both national classification and IPC		
B. FIELDS SEARCHED		
Minimum documentation searched (classification system followed by classification symbols) <i>G09G3/36, G02F1/133, G02F1/1343, G09G3/20, G09G5/02, H04N9/30</i>		
Documentation searched other than minimum documentation to the extent that such documents are included in the fields searched <i>Jitsuyo Shinan Koho 1922-1996 Jitsuyo Shinan Toroku Koho 1996-2010</i> <i>Kokai Jitsuyo Shinan Koho 1971-2010 Toroku Jitsuyo Shinan Koho 1994-2010</i>		
Electronic data base consulted during the international search (name of data base and, where practicable, search terms used)		
C. DOCUMENTS CONSIDERED TO BE RELEVANT		
Category*	Citation of document, with indication, where appropriate, of the relevant passages	Relevant to claim No.
A	JP 2004-525402 A (International Business Machines Corp.), 19 August 2004 (19.08.2004), entire text; all drawings & US 6801220 B2 & GB 2387955 A & WO 2002/059685 A2 & TW 567462 B & CN 1488124 A	1-16
A	JP 2003-255908 A (Matsushita Electric Industrial Co., Ltd.), 10 September 2003 (10.09.2003), paragraphs [0067] to [0075]; fig. 5, 7, 12 to 13 (Family: none)	1-16
<input checked="" type="checkbox"/> Further documents are listed in the continuation of Box C. <input type="checkbox"/> See patent family annex.		
* Special categories of cited documents: "A" document defining the general state of the art which is not considered to be of particular relevance "E" earlier application or patent but published on or after the international filing date "L" document which may throw doubts on priority claim(s) or which is cited to establish the publication date of another citation or other special reason (as specified) "O" document referring to an oral disclosure, use, exhibition or other means "P" document published prior to the international filing date but later than the priority date claimed		"T" later document published after the international filing date or priority date and not in conflict with the application but cited to understand the principle or theory underlying the invention "X" document of particular relevance; the claimed invention cannot be considered novel or cannot be considered to involve an inventive step when the document is taken alone "Y" document of particular relevance; the claimed invention cannot be considered to involve an inventive step when the document is combined with one or more other such documents, such combination being obvious to a person skilled in the art "&" document member of the same patent family
Date of the actual completion of the international search 23 March, 2010 (23.03.10)		Date of mailing of the international search report 06 April, 2010 (06.04.10)
Name and mailing address of the ISA/ Japanese Patent Office		Authorized officer
Facsimile No.		Telephone No.

Form PCT/ISA/210 (second sheet) (July 2009)

INTERNATIONAL SEARCH REPORT

International application No.
PCT/JP2009/007233

C (Continuation). DOCUMENTS CONSIDERED TO BE RELEVANT		
Category*	Citation of document, with indication, where appropriate, of the relevant passages	Relevant to claim No.
A	WO 2007/097080 A1 (Sharp Corp.), 30 August 2007 (30.08.2007), entire text; all drawings & US 2009/0167657 A & EP 1990678 A1 & CN 101389999 A	1-16

REFERENCES CITED IN THE DESCRIPTION

This list of references cited by the applicant is for the reader's convenience only. It does not form part of the European patent document. Even though great care has been taken in compiling the references, errors or omissions cannot be excluded and the EPO disclaims all liability in this regard.

Patent documents cited in the description

- JP 2006209135 A [0009]
- JP 2007226242 A [0009]
- JP 2004525402 PCT [0009]
- JP 11242225 A [0177]
- JP 2003043525 A [0191]
- JP 2004062146 A [0210]
- JP 2004078157 A [0210]
- JP 2008335246 A [0308]
- JP 2009132500 A [0308]

专利名称(译)	液晶显示装置		
公开(公告)号	EP2378509A1	公开(公告)日	2011-10-19
申请号	EP2009834499	申请日	2009-12-25
[标]申请(专利权)人(译)	夏普株式会社		
申请(专利权)人(译)	夏普株式会社		
当前申请(专利权)人(译)	夏普株式会社		
[标]发明人	MORI TOMOHIKO TOMIZAWA KAZUNARI YOSHIDA YUICHI		
发明人	MORI, TOMOHIKO TOMIZAWA, KAZUNARI YOSHIDA, YUICHI		
IPC分类号	G09G3/36 G02F1/133 G02F1/1343 G09G3/20 G09G5/02 H04N9/30		
CPC分类号	G09G3/3614 G09G3/3607 G09G3/3648 G09G5/02 G09G2300/0426 G09G2300/0447 G09G2300/0452 G09G2320/0242 G09G2320/0666 G09G2320/068 G09G2340/06		
优先权	2008335246 2008-12-26 JP 2009132500 2009-06-01 JP		
其他公开文献	EP2378509B1 EP2378509A4		
外部链接	Espacenet		

摘要(译)

根据本发明的液晶显示装置 (100) 包括像素 (P1) 和 (P2) , 每个像素包括三个子像素 (R1 , G1 , B1) 和 (R2 , G2 , B2) 。当输入信号指示应该表示彩色时, 子像素 (B1和B2) 中的一个接通, 并且子像素 (R1 , R2 , G1和G2) 中的至少一个也接通。如果在输入信号表示应该表示彩色的情况下子像素 (B1和B2) 的平均亮度在输入信号表示输入信号的另一种情况下基本上等于子像素 (B1和B2) 的平均亮度。应该表示无彩色, 前一种情况下这些子像素 (B1和B2) 的亮度与后一种情况下的子像素 (B1和B2) 的亮度不同。

